

TUBTARA®

Blind rivet nuts

General catalogue



TUBTARA® 60 years of innovation!
EN 9100: 2009
accreditation for the aerospace



New coatings, development of
the watertight HX **TUBTARA®**
in stainless 304 & 316

Year dedicated to R&D despite the
tough economical situation worldwide



Important investments in the
production unit e.g. new
degreasing and tapping machines

TUBTARA® celebrates its
50th birthday!

Opening of an extension to the
production facility

Dejong becomes one of the first
European manufacturers producing cold
formed blind rivet nuts

Dejong starts to manufacture solid rivets

2014

2013

2012

2010

2009

2008

2007

2005

2004

2002

2000

1989

1966

1954

1938

1901

First to cold form Tubtara's in
stainless A5 & A6

Development of the
Anti-turn **TUBTARA®**

New heading machine for
production of more difficult parts

First to cold form blind rivet nuts in
stainless steel 316
Zinktop: Dejong's new Cr^{VI}-free surface
treatment

ISO 9001/2000 accreditation by BVQI
(Bureau Veritas)

First to cold form blind rivet nuts in
stainless steel 304

Launch of the **TUBTARA®**
blind rivet nut

Foundation of the company by
the family Dejong



Contents

General Information	2	Steel	33
Dejong: an overview	2	Round shank	
Cold Forming Division	3	Flat head	33
TUBTARA® Blind rivet nuts	4	Countersunk head	35
		Low profile head	37
		Anti-turn head	39
Stainless Steel 304	8	Knurled shank	
Round shank		Flat head	40
Flat head	8	Low profile head	41
Countersunk head	10	Hexagonal shank	
Low profile head	11	Flat head	42
Anti-turn head	13	Low profile head	45
Knurled shank		Flat head with underhead seal	47
Flat head	14	Splined shank	
Low profile head	15	Flat head	48
Semi-hexagonal shank		Countersunk head	49
Flat head	16		
Low profile head	18	Aluminium	50
Flat head with underhead seal	20	Round shank	
Unified threads	22	Flat head	50
		Countersunk head	52
Stainless Steel 316	23	Low profile head	54
Round shank		Specials: Customized Solutions	55
Flat head	23	Latest Developments	56
Countersunk head	25	Setting Tools	61
Low profile head	26	Setting equipment	61
Semi-hexagonal shank		Technical Information	63
Flat head	28	Setting method	63
Low profile head	30	Materials	64
Flat head with underhead seal	32	Coatings	67
		Technical Data	69
		3D drawings	75

Dejond: an overview

Started as a small metal stockist in 1901, Dejond turned into a leading and reputed supplier to the industry over the years. Located in Wilrijk (Antwerp), about 100 employees, spread over 4 business units, are dedicated to maintain the long term partnerships with their customers and suppliers around the globe and find new business opportunities.



Core business :

- stockkeeping wholesaler of non-ferrous metals with service center,
- distributor of exclusive architectural and building systems,
- industrial supplier of high quality, value-added mechanical fasteners and fastening systems,
- R&D, production, marketing and sales of **TUBTARA®** blind rivet nuts (Cold Forming Division)

Dejond continuously aims to increase service and customer satisfaction. Considerable investments in all 4 business units over the years should help Dejond to strengthen its position of trendsetter and specialist in new technical developments.

The stylishly renovated building in Antwerp reflects Dejond's clear view for the future: professionalism. Dejond's name stands for high quality products, a multi-industry supply, prompt orderprocessing, on time deliveries and a reliable (aftersales-) service.

Dejond does not only deliver products, it primarily offers a strong customer support.

• Dejond: the industrial specialist in fastening technology

On its home market Dejond has become a major player in fastening technology by offering a full range of high quality mechanical fasteners manufactured by different internationally recognized suppliers, including its own **TUBTARA®** blind rivet nut range. It serves the general, automotive and aerospace industries.

Thanks to the regular product trainings at the suppliers, its in house expertise and the continuous search for new products, Dejond's people are able to keep pace with the latest market requirements & trends. In strong partnership with its suppliers, Dejond tries to solve its customers' problems and offer the appropriate product for their specific applications.

In other words : offer a total quality solution.

Dejond is EN 9100 certified for the distribution of high value fastening systems, a special requirement of the aerospace industry.



Cold Forming Division

In 1954 Dejong launched its first **TUBTARA®** blind rivet nuts, machined on a lathe. Only 10 years later the production started specializing in cold forming technology. Today Dejong offers one of the widest, cold formed ranges of high quality blind rivet nuts in the world, all manufactured in its EN 9100 certified production facility in Wilrijk (Antwerp, Belgium). **TUBTARA®** is Dejong's registered brandname.

Besides blind rivet nuts, Dejong also concentrates on cold forming selected parts according to customers' drawings for very specific applications.

Standard as well as special products are made of steel, stainless steel, or aluminium.

The entire cold forming team is more than ever committed to meet the challenges that lie ahead. By manufacturing in an environmentally friendly way, it tries to minimize the influence of its activities on the environment and create a balance between economical, social and environmental aspects. Together with its focus on R&D, Dejong wants to reach the highest quality ever.

Dejong has the ambition to stay at the forefront of the design and manufacture of blind rivet nuts as innovation is our essential strength.

Through short delivery times and a strong technical & commercial support, Dejong tries to give its partners-distributors the opportunity to gain new applications worldwide. Thanks to its flexible stock availability & central location near the port of Antwerp and Brussels airport, customers of all continents receive their **TUBTARA®** blind rivet nuts at short notice.



TUBTARA® : your reliable connection



TUBTARA® Blind rivet nuts

TUBTARA® is a mechanical fastener that ensures a strong thread in thin and thick metal plates / profiles, composites or plastics. It is used in applications where there is little or no access at the rear. It can clinch separate sheets together (acting as a rivet) and allows you to assemble another component with a bolt or screw.

● Benefits

- Simple blind (one sided) installation
- Fast assembly time : the speed & ease of assembly reduces the cost of **TUBTARA®** versus other methods of providing threads in plates or profiles
- Low assembly costs
- Avoids damaging the surface of the workpiece: can be installed in pre-coated or pre-painted applications ensuring a clean undamaged thread
- No deformation of the workpiece
- Low installation cost : no expensive setting tools needed
- Works in close-to-edge applications
- Retained fastener cfr. machinery directive 2006/42/EC
- Appropriate for repeated assembly

● Installation

Installing a **TUBTARA®** blind rivet nut is very simple : screw the **TUBTARA®** on the mandrel of the setting tool, bring it into the hole of the workpiece, pull lengthwise to set the **TUBTARA®** and unscrew the mandrel. (For more detailed information on the setting method [see pg 63](#))

A **TUBTARA®** can be set with a hand- or pneumatic tool, a press or an automatic installation unit.

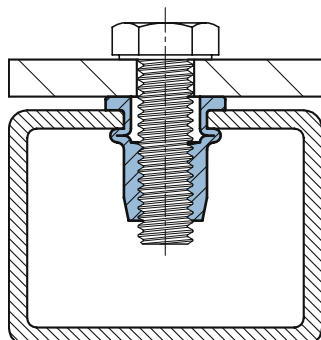

● Applications

A **TUBTARA®** is used in all kinds of sheet metal and composite applications. It avoids tapping, welding and working with a bolt and nut. It's a very good solution for enclosed applications that can only be accessed from one side. Some marketsegments:

- Aerospace
- Automotive
- White Goods
- Electronics
- Metal furniture
- Railways
- Telecom
- Food
- Chemicals
- Lighting
- Marine
- Offshore
- Medical
- Pulp & paper
- etc...

e.g. cabinets, pipes, cable trays, leg levelling, window & door profiles, rails, benches, fences, metal enclosures, heating installations, airconditioning, swimming pools, solar panels etc.



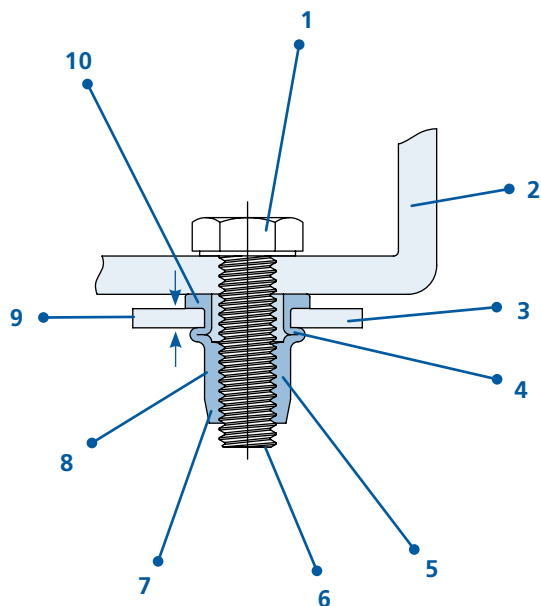

● **Terminology**

1. Screw or bolt inserted for assembly
2. Assembled part
3. Workpiece: can be 1 sheet or several sheets which have to be clinched
4. Bulb or counterhead: the chamber (unthreaded part) of the **TUBTARA®** deformed during setting
5. Strong, secured internal thread of the **TUBTARA®**
6. Open or closed end: closed version minimizes the ingress of dirt & fluids especially in combination with an underhead seal (HX-versions see [pg 20, 32, 47, 58](#))
7. Chamfer: leads the **TUBTARA®** into the hole
8. Shank: round, (semi-)hexagonal, knurled or splined version
9. Grip: the exact material thickness of the workpiece
10. Head: flat, countersunk, low profile, water-tight, anti-turn or customized head types

● **Product Description**

Steel	M5	RS	UFO	40
Stainless	M10	H	SPX	35
Aluminium	M8	-	UPO	80
Steel	M6	-	MPO	50
Steel	M4	KN	UKO	30
↓	↓	↓	↓	↓
material	thread	shank	head & shank	max grip
		RS: splined H: hexagonal KN: knurled - : round	U / S: Unigrip M: Multigrip F: countersunk head P: flat head K: low profile head O: open end X: closed end	40 = 4 mm 35 = 3,5 mm 80 = 8 mm 50 = 5 mm 30 = 3 mm

● **How to choose the appropriate TUBTARA® ?**

- What kind of material and surface treatment do you need?
- What is the required thread size?
- Choose the correct grip range for the required material thickness of the application.
- Choose the required head and shank style.
- Do you need an open or closed version?
- Check the technical characteristics of the chosen **TUBTARA®**.

We advise you to do some tests on the suitable product in the specific application on beforehand.
Samples are available on request.



● **Specials**

Don't you find the appropriate **TUBTARA®** in this catalogue?

TUBTARA® blind rivet nuts manufactured to customers' specifications, can be developed to suit the demands of almost every application.

Always take the following into consideration:

- Give us an accurate description of the application.
- Do you have a drawing with indication of sizes, tolerances and exact sheet thickness?
- Are there other special features and important remarks we need to know?
- Can you give us a sample of the application and/or present fastener?
- Do you have special technical requirements like torque value, upset load, tensile or thread strength etc.?
- What type of setting equipment will be used?

Our R&D people will evaluate your request and our Sales Department will provide you with information.

Few examples of additional features providing innovative solutions for your problems :

- Increased torque-to-turn / spin-out resistance
- Spacer function
- Controlled deformation
- (Full) integration into parent material (e.g. composites)
- Flush installation
- Seal function
- Visual identification
- Centering
- Search function (for automatic installation)
- Pressure spread
- Facilitate field repair (increased torque-to-turn resistance)
- Compatibility with fasteners
- Compatibility with tools
- Drip / dry function (paint, oil, ...)
- Blind installation / limited space
- Special thread requirements
- (Electrical) conductivity
- Increased push-out force
- Increased pull-out force (thread strength)
- Anti-vibration
- Customized grip (range)



**Order our new brochure
on customized solutions!**





Stainless Steel 304

Round shank
Flat head
Open end

UPO / SPO

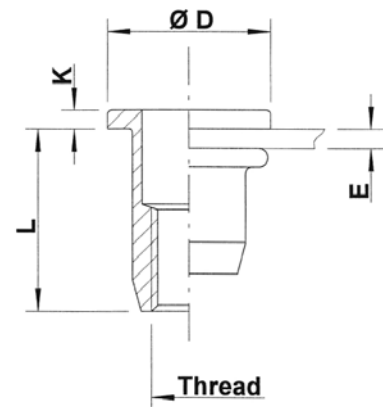
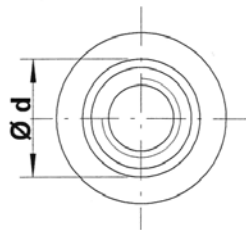
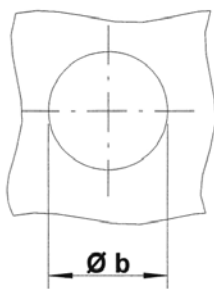

THREAD	TYPE	E = grip	L	b ^{+0,1} = drill dia	d = shank dia	D	K	kg/1000	ORDER CODE	BOX Q
M4	UPO20	0,5-2,0	11,0	6,0	6,0	9,0	1,0	1,5	544 010	7500
	UPO35	2,0-3,5	12,5					1,6	544 020	5000
M5	UPO30	0,5-3,0	11,5	7,0	7,0	10,0	1,0	1,8	545 040	4000
	UPO50	3,0-5,0	15,0					2,2	545 050	3000
M6	UPO30	0,5-3,0	14,5	9,0	9,0	12,0	1,5	4,1	546 020	2000
	UPO50	3,0-5,0	16,5					4,4	546 035	2000
	UPO70	5,0-7,0	18,5					4,8	546 050	-
M8	UPO30	0,5-3,0	16,0	11,0	11,0	15,0	1,5	6,1	548 010	1250
	UPO55	3,0-5,5	18,5					6,5	548 020	1250
	UPO80	5,5-8,0	21,5					7,1	548 035	1000
M10	UPO30	0,8-3,0	18,5	12,1	12,0	15,0	1,0	5,9	540 020	1000
	UPO50	3,0-5,0	20,5					6,0	540 030	1000
M10	SPO35	0,8-3,5	21,5	13,0	13,0	17,0	1,5	10,2	540 600	750
	SPO60	3,5-6,0	24,0					10,9	540 605	750

All dimensions in mm - Technical data subject to modification
Tolerances and characteristics see chapter "Technical Data"





Stainless Steel 304

Round shank
Flat head
Closed end

UPX / SPX

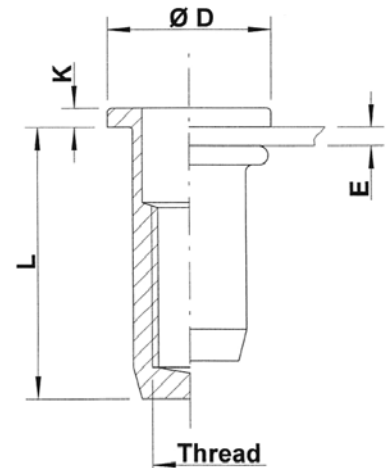
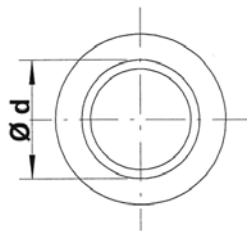
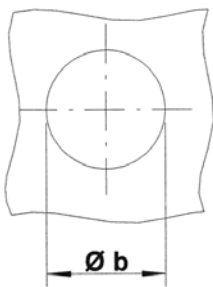

THREAD	TYPE	E = grip	L	b ^{+0,1} = drill dia	d = shank dia	D	K	kg/1000	ORDER CODE	BOX Q
M4	UPX20	0,5-2,0	15,0	6,0	6,0	9,0	1,0	2,2	544 110	5000
M5	UPX30	0,5-3,0	17,5	7,0	7,0	10,0	1,0	3,0	545 180	2500
M6	UPX30	0,5-3,0	21,5	9,0	9,0	12,0	1,5	6,6	546 100	1500
	UPX50	3,0-5,0	23,5					6,9	546 105	1500
M8	UPX30	0,5-3,0	23,5	11,0	11,0	15,0	1,5	9,9	548 065	1000
	UPX55	3,0-5,5	26,0					10,2	548 066	750
M10	SPX35	0,8-3,5	28,5	13,0	13,0	17,0	1,5	15,0	540 630	500

All dimensions in mm - Technical data subject to modification
Tolerances and characteristics see chapter "Technical Data"





Stainless Steel 304

Round shank
Countersunk head
Open end

UFO / SFO

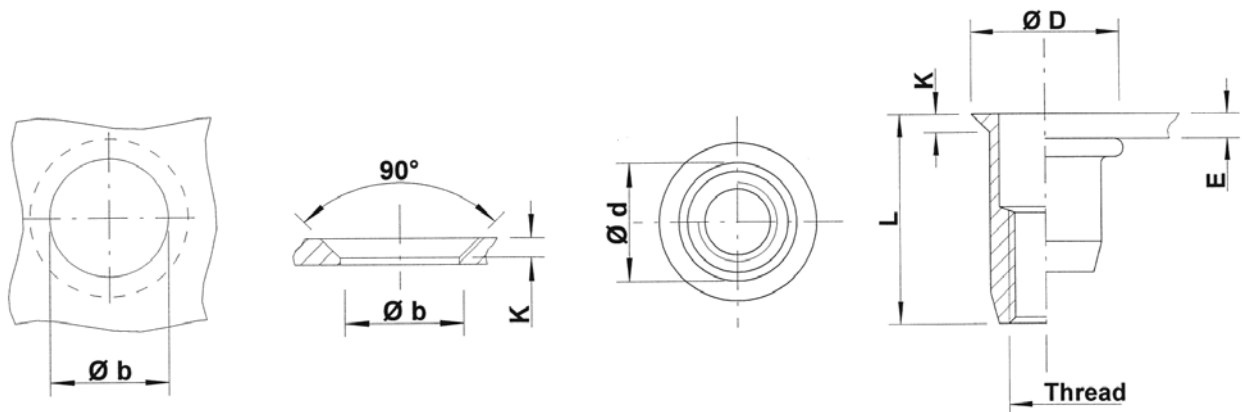

THREAD	TYPE	E = grip	L	b ^{+0,1} = drill dia	d = shank dia	D	K	kg/1000	ORDER CODE	BOX Q
M4	UFO30	1,2-3,0	12,0	6,0	6,0	8,0	1,0	1,3	544 120	7500
M5	UFO35	1,2-3,5	12,0	7,0	7,0	9,0	1,0	1,6	545 200	5000
M6	UFO45	1,7-4,5	17,0	9,0	9,0	12,0	1,5	4,2	546 125	2000
M8	UFO45	1,7-4,5	17,5	11,0	11,0	14,0	1,5	5,5	548 070	1250
	UFO65	4,5-6,5	19,5					5,8	548 075	1250
M10	UFO45	1,7-4,5	20,0	12,1	12,0	15,0	1,5	5,9	540 090	1000
M10	SFO45	1,7-4,5	22,5	13,0	13,0	16,0	1,5	9,5	540 610	750

All dimensions in mm - Technical data subject to modification
Tolerances and characteristics see chapter 'Technical Information'





Stainless Steel 304

Round shank
Low profile head
Open end

UKO / SKO

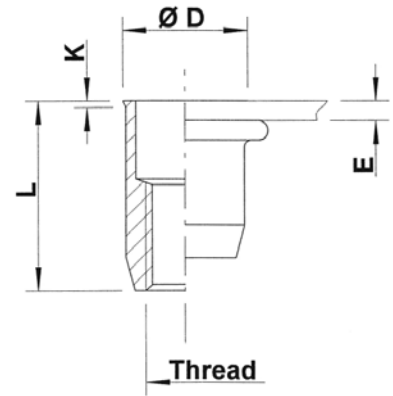
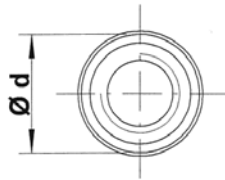
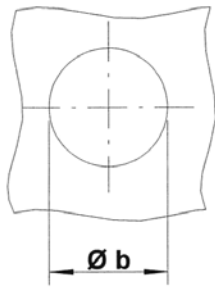

THREAD	TYPE	E = grip	L	b ^{+0,1} = drill dia	d = shank dia	D	K	kg/1000	ORDER CODE	BOX Q
M4	UKO20	0,5-2,0	11,0	6,0	6,0	6,5	0,5	1,1	544 220	10000
M5	UKO30	0,5-3,0	12,0	7,0	7,0	7,5	0,5	1,5	545 400	5000
	UKO50	3,0-5,0	15,0					1,8	545 420	5000
M6	UKO30	0,5-3,0	14,5	9,0	9,0	9,5	0,5	3,4	546 400	3000
M8	UKO30	0,5-3,0	16,0	11,0	11,0	11,5	0,5	5,0	548 160	2000
	UKO55	3,0-5,5	18,5					5,5	548 180	1500
M10	SKO35	0,8-3,5	21,0	13,0	13,0	13,5	0,5	8,5	540 620	1000

All dimensions in mm - Technical data subject to modification
Tolerances and characteristics see chapter 'Technical Information'





Stainless Steel 304

Round shank
Low profile head
Closed end

UKX

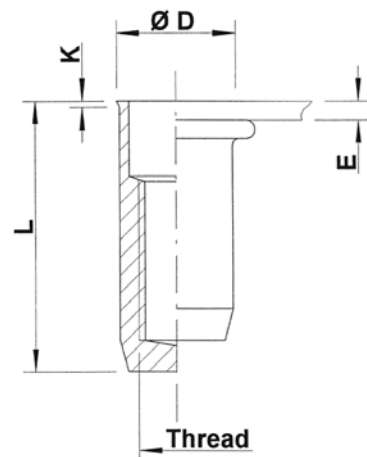
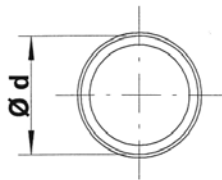
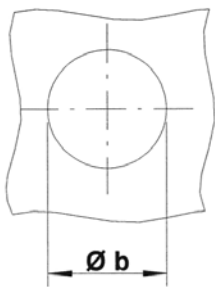

THREAD	TYPE	E = grip	L	b ^{+0,1} = drill dia	d = shank dia	D	K	kg/1000	ORDER CODE	BOX Q
M4	UKX20	0,5-2,0	15,5	6,0	6,0	6,5	0,5	1,9	544 250	5000
M5	UKX30	0,5-3,0	18,0	7,0	7,0	7,5	0,5	2,7	545 450	4000
M6	UKX30	0,5-3,0	21,5	9,0	9,0	9,5	0,5	5,8	546 450	2000
M8	UKX30	0,5-3,0	24,0	11,0	11,0	11,5	0,5	8,8	548 190	1250

M10: programme in progress

All dimensions in mm - Technical data subject to modification
Tolerances and characteristics see chapter 'Technical Information'





Stainless Steel 304

Round shank
Anti-turn head
Open end

ATO

**repair solution:
extra high
torque-to-turn values**

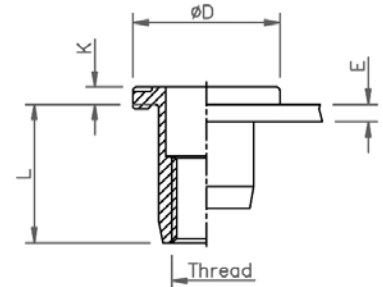
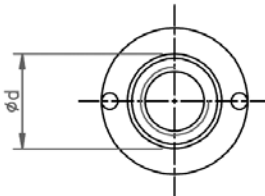
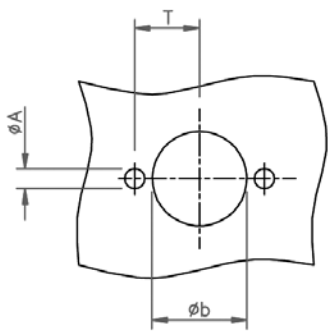

THREAD	TYPE	E = grip	L	b ^{+0,1} = drill dia	d = shank dia	D	K	A	T	kg/1000	ORDER CODE	BOX Q
M6	ATO30	0,5-3,0	14,5	9,0	9,0	14,0	1,5	1,8	6,25	-	-	-
M8	ATO30	0,5-3,0	16,0	11,0	11,0	17,0	2,0	2,3	7,5	7,4	548 1010*	1200
	ATO55	3,0-5,5	18,5								548 1020*	1000
M10	ATO35	0,8-3,5	21,0	13,0	13,0	19,0	2,0	3,0	8,75	11,3	540 1600*	750

Tool to position Ø A:

M6	AT 206
M8	AT 208
M10	AT 210



Samples available from stock - general info [see pg 60](#)

All dimensions in mm - Technical data subject to modification
Tolerances and characteristics see chapter 'Technical Information'





Stainless Steel 304

Knurled shank
Flat head
Open end

UPO KN

improved
nominal knurl

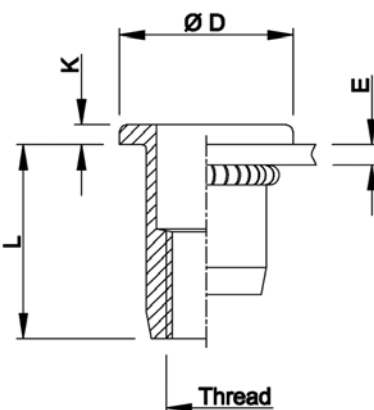
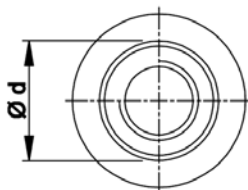

THREAD	TYPE	E = grip	L	b ^{+0,1} = drill dia	d = shank dia	D	K	kg/1000	ORDER CODE	BOX Q
M4	UPO20 KN	0,5-2,0	11,0	6,0	6,0	9,0	1,0	1,5	544 0107*	7500
M5	UPO30 KN	0,5-3,0	11,5	7,0	7,0	10,0	1,0	1,8	545 0407*	4000
M6	UPO30 KN	0,5-3,0	14,5	9,0	9,0	12,0	1,5	4,1	546 0207	2000
M8	UPO30 KN	0,5-3,0	16,0	11,0	11,0	15,0	1,5	6,1	548 0107*	1250

* **Non-stock item:** minimum order quantity required after depletion of stock

KN programme in progress (also UFO-version)

All dimensions in mm - Technical data subject to modification
Tolerances and characteristics see chapter 'Technical Information'





Stainless Steel 304

Knurled shank
Low profile head
Open end

UKO KN

improved
nominal knurl

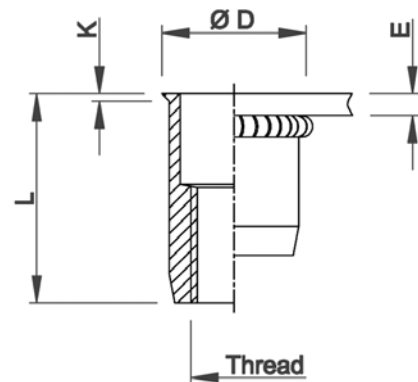
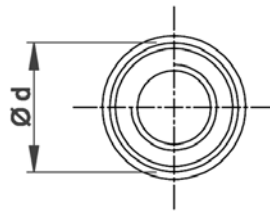

THREAD	TYPE	E = grip	L	b ^{+0,1} = drill dia	d = shank dia	D	K	kg/1000	ORDER CODE	BOX Q
M4	UKO20 KN	0,5-2,0	11,0	6,0	6,0	6,5	0,5	1,1	544 2207	10000
M5	UKO30 KN	0,5-3,0	12,0	7,0	7,0	7,5	0,5	1,5	545 4007	5000
M6	UKO30 KN	0,5-3,0	14,5	9,0	9,0	9,5	0,5	3,4	546 4007	3000
M8	UKO30 KN	0,5-3,0	16,0	11,0	11,0	11,5	0,5	5,0	548 1607	2000

KN programme in progress (also UFO-version)

All dimensions in mm - Technical data subject to modification
Tolerances and characteristics see chapter 'Technical Information'





Stainless Steel 304

Semi-hexagonal shank
Flat head
Open end

HUPO / HSPO

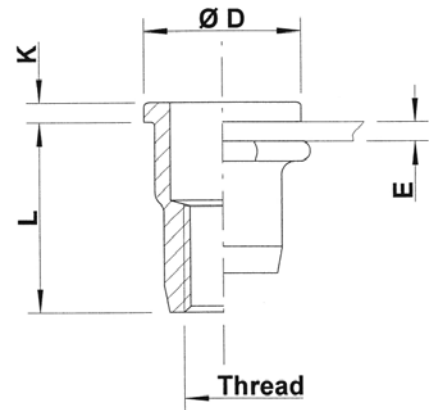
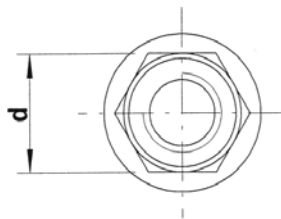
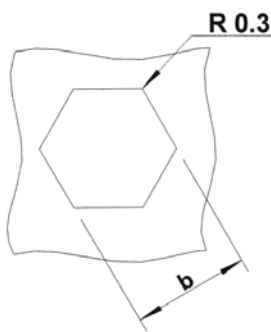

THREAD	TYPE	E = grip	L	b ^{+0,1} = hex hole	d = hex shank	D	K	kg/1000	ORDER CODE	BOX Q
M4	HUPO20	0,5-2,0	11,0	6,0	6,0	9,0	1,0	1,5	544 500	7500
M5	HUPO30	0,5-3,0	11,5	7,0	7,0	10,0	1,0	1,8	545 500	4000
M6	HUPO30	0,5-3,0	14,5	9,0	9,0	12,0	1,5	4,0	546 460	2500
M8	HUPO30	0,5-3,0	16,0	11,0	11,0	15,0	1,5	6,1	548 250	1250
	HUPO55	3,0-5,5	18,5					6,4	548 270	1000
M10	HSPO35	0,8-3,5	21,5	13,0	13,0	17,0	1,5	-	540 632	-

All dimensions in mm - Technical data subject to modification
Tolerances and characteristics see chapter 'Technical Information'





Stainless Steel 304

Semi-hexagonal shank
Flat head
Closed end

HUPX / HSPX

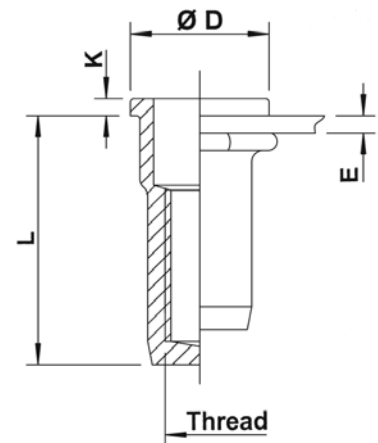
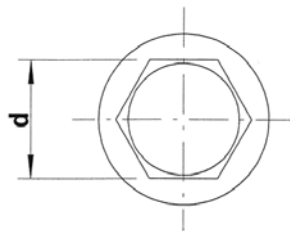
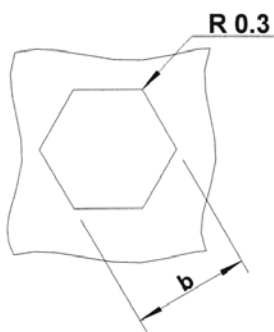

THREAD	TYPE	E = grip	L	b ^{+0,1} = hex hole	d = hex shank	D	K	kg/1000	ORDER CODE	BOX Q
M4	HUPX20	0,5-2,0	15,0	6,0	6,0	9,0	1,0	2,2	544 520	5000
M5	HUPX30	0,5-3,0	17,5	7,0	7,0	10,0	1,0	3,0	545 520	2500
M6	HUPX30	0,5-3,0	21,5	9,0	9,0	12,0	1,5	6,6	546 470	1500
M8	HUPX30	0,5-3,0	23,5	11,0	11,0	15,0	1,5	9,6	548 260	750
M10	HSPX35	0,8-3,5	28,5	13,0	13,0	17,0	1,5	14,7	540 635	500

All dimensions in mm - Technical data subject to modification
Tolerances and characteristics see chapter 'Technical Information'





Stainless Steel 304

Semi-hexagonal shank
Low profile head
Open end

HUKO / HSKO

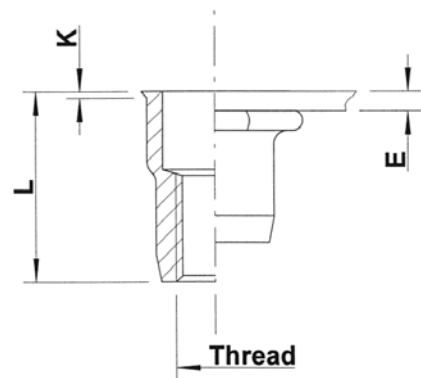
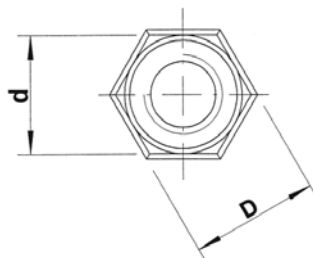
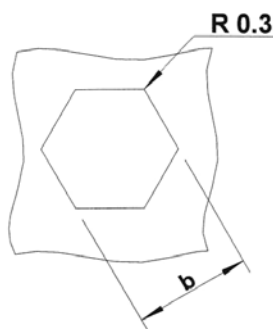

THREAD	TYPE	E = grip	L	b ^{+0,1} = hex hole	d = hex shank	D = hex head	K	kg/1000	ORDER CODE	BOX Q
M4	HUKO20	0,5-2,0	11,0	6,0	6,0	6,5	0,5	1,2	544 600	7500
M5	HUKO30	0,5-3,0	12,0	7,0	7,0	7,5	0,5	1,5	545 600	5000
	HUKO50	3,0-5,0	14,0					1,7	545 605	5000
M6	HUKO30	0,5-3,0	14,5	9,0	9,0	9,5	0,5	3,3	546 500	3000
	HUKO50	3,0-5,0	16,5					3,6	546 525	2500
	HUKO70	5,0-7,0	18,5					3,9	546 580	2000
M8	HUKO30	0,5-3,0	16,0	11,0	11,0	11,5	0,5	4,9	548 300	2000
	HUKO55	3,0-5,5	18,5					5,3	548 305	1500
M10	HSKO35	0,8-3,5	21,0	13,0	13,0	13,5	0,7	-	540 640*	-
	HSKO60	3,5-6,0	23,5					-	540 645*	-

* **Non-stock item:** minimum order quantity required after depletion of stock

All dimensions in mm - Technical data subject to modification
Tolerances and characteristics see chapter 'Technical Information'





Stainless Steel 304

Semi-hexagonal shank
Low profile head
Closed end

HUKX

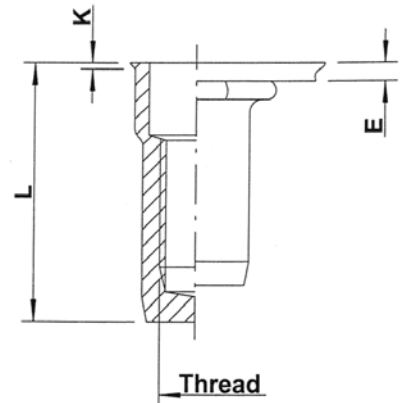
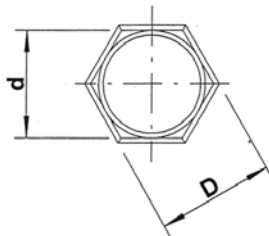
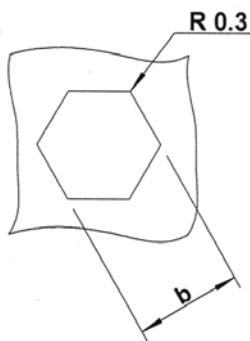

THREAD	TYPE	E = grip	L	b ^{+0,1} = hex hole	d = hex shank	D = hex head	K	kg/1000	ORDER CODE	BOX Q
M4	HUKX20	0,5-2,0	15,5	6,0	6,0	6,5	0,5	1,8	544 620	5000
M5	HUKX30	0,5-3,0	18,0	7,0	7,0	7,5	0,5	2,7	545 620	4000
	HUKX50	3,0-5,0	20,5							
M6	HUKX30	0,5-3,0	21,5	9,0	9,0	9,5	0,5	5,7	546 540	2000
	HUKX50	3,0-5,0	23,5							
M8	HUKX30	0,5-3,0	24,0	11,0	11,0	11,5	0,5	8,7	548 320	1000
	HUKX55	3,0-5,5	26,5							

M10: programme in progress

All dimensions in mm - Technical data subject to modification
Tolerances and characteristics see chapter 'Technical Information'





Stainless Steel 304

Semi-hexagonal shank
Flat head with underhead seal
Closed end

HX

watertight
10 bar (IP68)

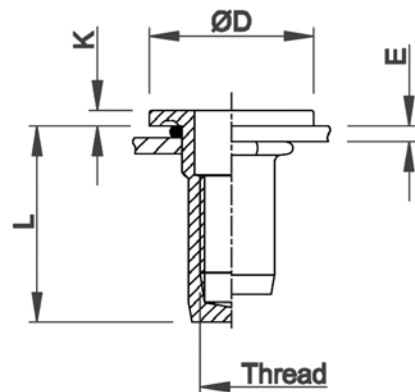
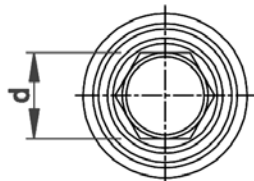
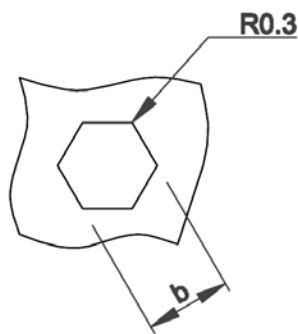

THREAD	TYPE	E = grip	L	b ^{+0,1} = hex hole	d = hex shank	D	K	kg/1000	ORDER CODE	BOX Q
M5	HX3001	0,5-3,0	19,0	7,0	7,0	13,5	1,5	3,8	545 905*	2500
M6	HX3001	0,5-3,0	21,5	9,0	9,0	16,0	1,5	7,5	546 903	1250
M8	HX3001	0,5-3,0	25,0	11,0	11,0	21,0	2,0	13,1	548 902	500

* **Non-stock item:** minimum order quantity required after depletion of stock

All dimensions in mm - Technical data subject to modification
Tolerances and characteristics see chapter 'Technical Information'

General and technical information (seal, storage): see [pg 58](#) and [pg 74](#)





Stainless Steel 304

Round shank
Low profile head
Open end

**UKO
UNIFIED THREAD**

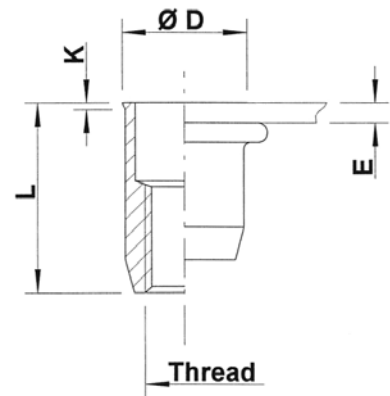
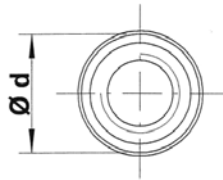
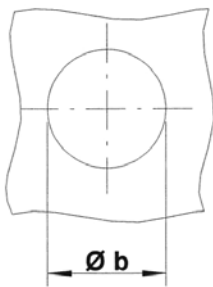

THREAD	TYPE	E = grip	L	b ^{+0,1} = drill dia	d = shank dia	D	K	kg/1000	ORDER CODE	BOX Q
10-32 UNF	UKO30	0,5-3,0	12,0	7,0	7,0	7,5	0,5	1,5	549 500	5000
1/4-20 UNC	UKO30	0,5-3,0	14,5	9,0	9,0	9,5	0,5	3,4	547 660	3000
5/16-18 UNC	UKO30	0,5-3,0	16,0	11,0	11,0	11,5	0,5	5,0	547 830	2000

All dimensions in mm

THREAD	TYPE	E = grip	L	b ^{+0.004} = drill dia	d = shank dia	D	K	lbs/1000	ORDER CODE	BOX Q
10-32 UNF	UKO30	.020-.118	0.472	0.276	0.276	0.295	.020	3.30	549 500	5000
1/4-20 UNC	UKO30	.020-.118	0.571	0.354	0.354	0.374	.020	7.49	547 660	3000
5/16-18 UNC	UKO30	.020-.118	0.630	0.433	0.433	0.453	.020	11.00	547 830	2000

All dimensions in inches - Technical data subject to modification
Tolerances and characteristics see chapter 'Technical Information'





Stainless Steel 304

Semi-hexagonal shank
Low profile head
Open end

HUKO
UNIFIED THREAD

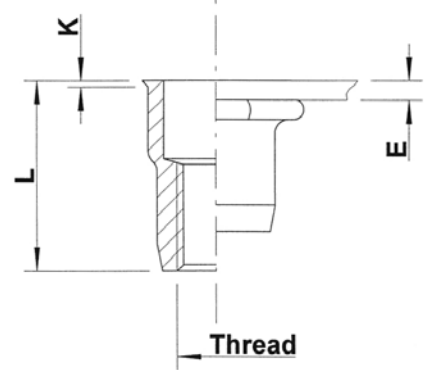
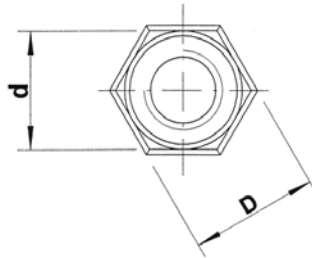
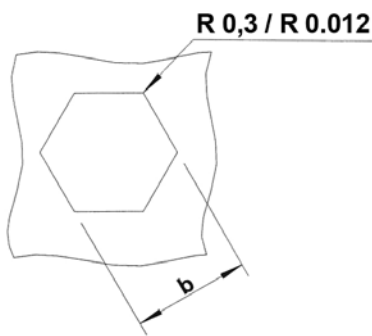

THREAD	TYPE	E = grip	L	b ^{+0,1} = hex hole	d = hex shank	D = hex head	K	kg/1000	ORDER CODE	BOX Q
10-32 UNF	HUKO30	0,5-3,0	12,0	7,0	7,0	7,5	0,5	1,5	549 530	5000
1/4-20 UNC	HUKO30	0,5-3,0	14,5	9,0	9,0	9,5	0,5	3,3	547 690	3000
5/16-18 UNC	HUKO30	0,5-3,0	16,0	11,0	11,0	11,5	0,5	4,9	547 850	2000

All dimensions in mm

THREAD	TYPE	E = grip	L	b ^{+0.004} = hex hole	d = hex shank	D = hex head	K	lbs/1000	ORDER CODE	BOX Q
10-32 UNF	HUKO30	.020-.118	0.472	0.276	0.276	0.295	.020	3.30	549 530	5000
1/4-20 UNC	HUKO30	.020-.118	0.571	0.354	0.354	0.374	.020	7.27	547 690	3000
5/16-18 UNC	HUKO30	.020-.118	0.630	0.433	0.433	0.453	.020	10.79	547 850	2000

All dimensions in inches - Technical data subject to modification
Tolerances and characteristics see chapter 'Technical Information'





Stainless Steel 316

(contains > 2% Molybden)

Round shank
Flat head
Open end

UPO / SPO

extra high
corrosion resistance

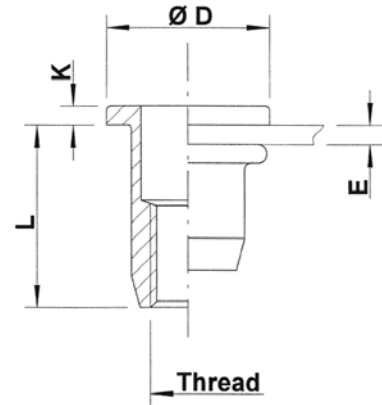
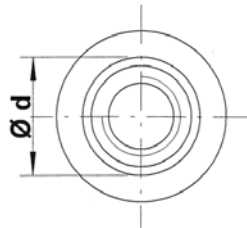
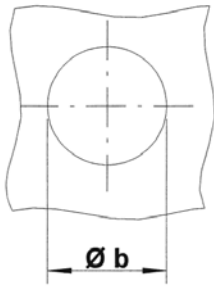

THREAD	TYPE	E = grip	L	b ^{+0,1} = drill dia	d = shank dia	D	K	kg/1000	ORDER CODE	BOX Q
M4	UPO20	0,5-2,0	11,0	6,0	6,0	9,0	1,0	1,5	554 010	3000
M5	UPO30	0,5-3,0	11,5	7,0	7,0	10,0	1,0	1,8	555 040	2000
M6	UPO30	0,5-3,0	14,5	9,0	9,0	12,0	1,5	4,1	556 020	1000
	UPO50	3,0-5,0	16,5					4,5	556 035	1000
	UPO70	5,0-7,0	18,5					4,7	556 050	750
M8	UPO30	0,5-3,0	16,0	11,0	11,0	15,0	1,5	6,1	558 010	500
	UPO55	3,0-5,5	18,5					-	558 020	-
	UPO70	4,5-7,0	20,0					6,9	558 030	500
M10	SPO35	0,8-3,5	21,5	13,0	13,0	17,0	1,5	10,4	550 600	250

All dimensions in mm - Technical data subject to modification
Tolerances and characteristics see chapter 'Technical Information'





Stainless Steel 316

(contains > 2% Molybden)

Round shank
Flat head
Closed end

UPX

extra high
corrosion resistance

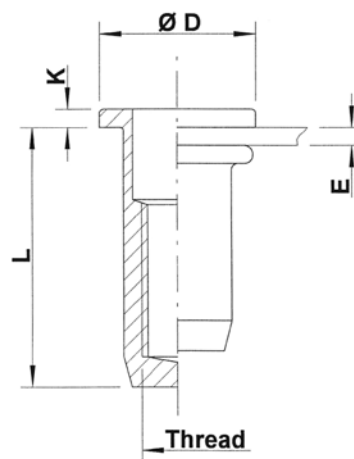
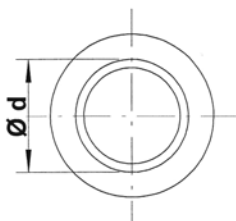
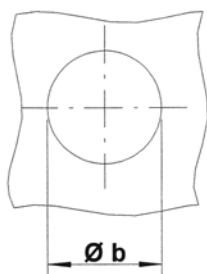

THREAD	TYPE	E = grip	L	b ^{+0,1} = drill dia	d = shank dia	D	K	kg/1000	ORDER CODE	BOX Q
M4	UPX20	0,5-2,0	15,0	6,0	6,0	9,0	1,0	2,2	554 110	1500
M5	UPX30	0,5-3,0	17,5	7,0	7,0	10,0	1,0	3,0	555 180	1500
M6	UPX30	0,5-3,0	21,5	9,0	9,0	12,0	1,5	6,6	556 100	750
M8	UPX30	0,5-3,0	23,5	11,0	11,0	15,0	1,5	9,9	558 065	1000

M10: programme in progress

All dimensions in mm - Technical data subject to modification
Tolerances and characteristics see chapter 'Technical Information'





Stainless Steel 316

(contains > 2% Molybden)

Round shank
Countersunk head
Open end

UFO / SFO

extra high
corrosion resistance

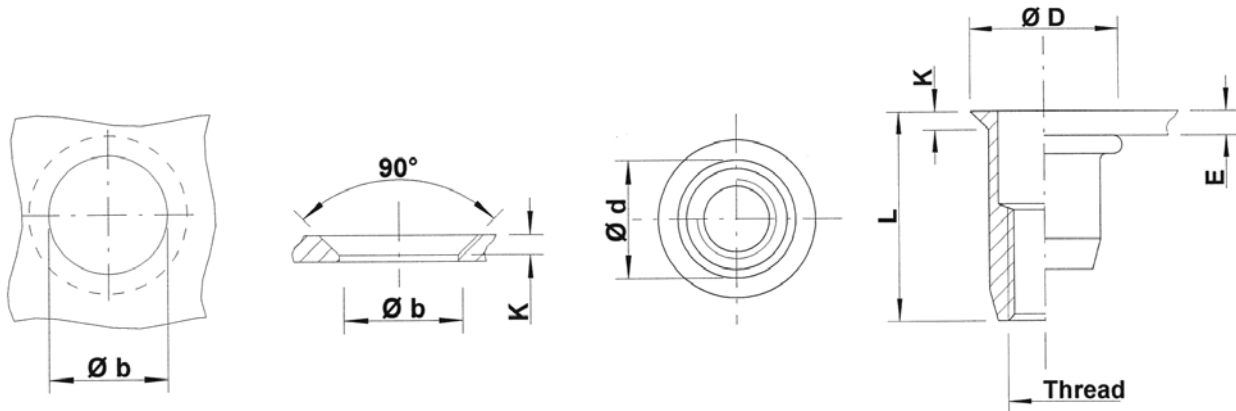

THREAD	TYPE	E = grip	L	b ^{+0,1} = drill dia	d = shank dia	D	K	kg/1000	ORDER CODE	BOX Q
M4	UFO30	1,2-3,0	12,0	6,0	6,0	8,0	1,0	1,3	554 120*	-
M5	UFO35	1,2-3,5	12,0	7,0	7,0	9,0	1,0	1,6	555 200	2000
M6	UFO45	1,7-4,5	17,0	9,0	9,0	12,0	1,5	4,2	556 125	1000
M8	UFO45	1,7-4,5	17,5	11,0	11,0	14,0	1,5	5,5	558 070	750
M10	SFO45	1,7-4,5	22,5	13,0	13,0	16,0	1,5	9,5	550 610*	750

* **Non-stock item:** minimum order quantity required after depletion of stock

All dimensions in mm - Technical data subject to modification
Tolerances and characteristics see chapter 'Technical Information'





Stainless Steel 316

(contains > 2% Molybden)

Round shank
Low profile head
Open end

UKO / SKO

extra high
corrosion resistance

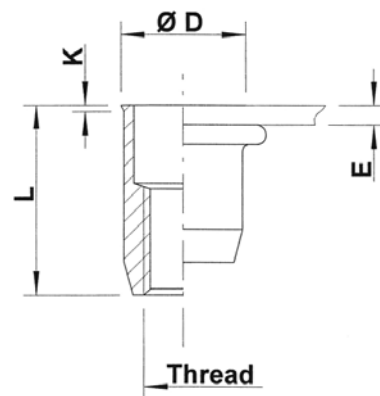
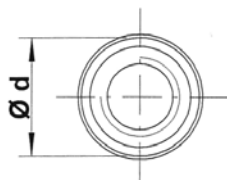

THREAD	TYPE	E = grip	L	b ^{+0,1} = drill dia	d = shank dia	D	K	kg/1000	ORDER CODE	BOX Q
M4	UKO20	0,5-2,0	11,0	6,0	6,0	6,5	0,5	1,2	554 220	3000
M5	UKO30	0,5-3,0	12,0	7,0	7,0	7,5	0,5	1,5	555 400	2000
M6	UKO30	0,5-3,0	14,5	9,0	9,0	9,5	0,5	3,4	556 400	1000
M8	UKO30	0,5-3,0	16,0	11,0	11,0	11,5	0,5	5,0	558 160	500
M10	SKO35	0,8-3,5	21,0	13,0	13,0	13,5	0,7	8,6	550 620	500

All dimensions in mm - Technical data subject to modification
Tolerances and characteristics see chapter 'Technical Information'





Stainless Steel 316

(contains > 2% Molybden)

Round shank
Low profile head
Closed end

UKX

extra high
corrosion resistance

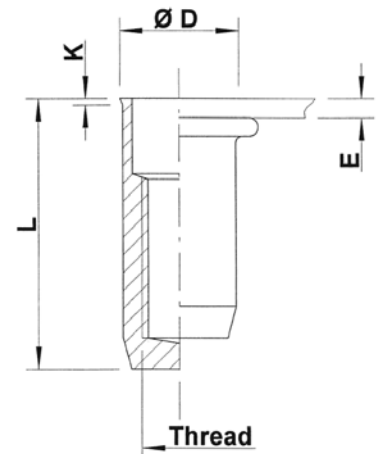
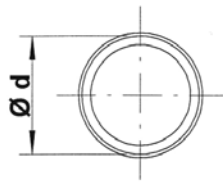

THREAD	TYPE	E = grip	L	b ^{+0,1} = drill dia	d = shank dia	D	K	kg/1000	ORDER CODE	BOX Q
M4	UKX20	0,5-2,0	15,5	6,0	6,0	6,5	0,5	1,9	554 250	2000
M5	UKX30	0,5-3,0	18,0	7,0	7,0	7,5	0,5	2,7	555 450	1500
M6	UKX30	0,5-3,0	21,5	9,0	9,0	9,5	0,5	5,8	556 450	1000
M8	UKX30	0,5-3,0	24,0	11,0	11,0	11,5	0,5	8,8	558 190	500

M10: programme in progress

All dimensions in mm - Technical data subject to modification
Tolerances and characteristics see chapter 'Technical Information'





Stainless Steel 316

(contains > 2% Molybden)

Semi-hexagonal shank
Flat head
Open end

HUPO / HSPO

extra high
corrosion resistance

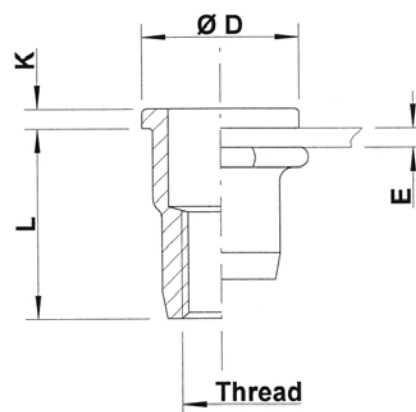
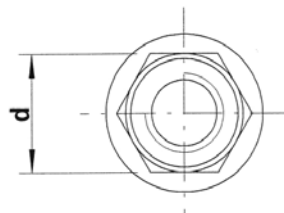
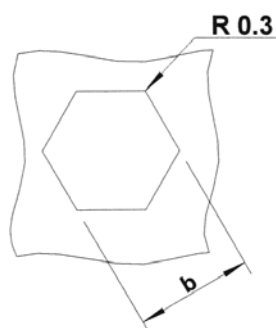

THREAD	TYPE	E = grip	L	b ^{+0,1} = hex hole	d = hex shank	D	K	kg/1000	ORDER CODE	BOX Q
M4	HUPO20	0,5-2,0	11,0	6,0	6,0	9,0	1,0	1,5	554 500	2500
M5	HUPO30	0,5-3,0	11,5	7,0	7,0	10,0	1,0	1,8	555 500	2000
M6	HUPO30	0,5-3,0	14,5	9,0	9,0	12,0	1,5	4,0	556 460	1000
M8	HUPO30	0,5-3,0	16,0	11,0	11,0	15,0	1,5	6,1	558 250	500
M10	HSPO35	0,8 - 3,5	21,5	13,0	13,0	17,0	1,5	-	550 632	-

All dimensions in mm - Technical data subject to modification
Tolerances and characteristics see chapter 'Technical Information'





Stainless Steel 316

(contains > 2% Molybden)

Semi-hexagonal shank
Flat head
Closed end

HUPX

extra high
corrosion resistance

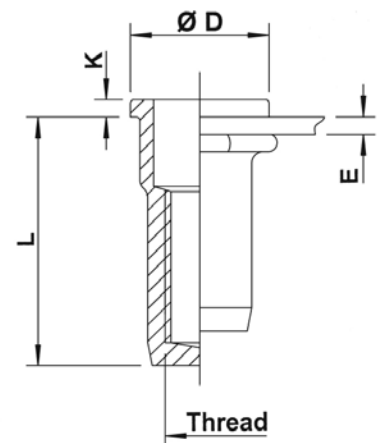
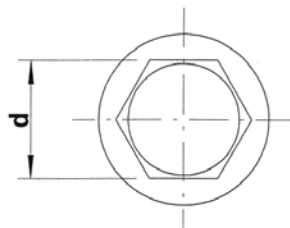
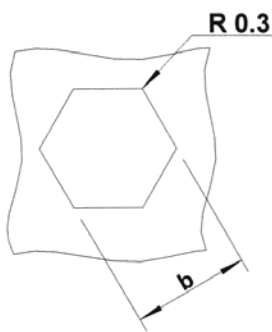

THREAD	TYPE	E = grip	L	b ^{+0,1} = hex hole	d = hex shank	D	K	kg/1000	ORDER CODE	BOX Q
M4	HUPX20	0,5-2,0	15,0	6,0	6,0	9,0	1,0	2,2	554 520	2000
M5	HUPX30	0,5-3,0	17,5	7,0	7,0	10,0	1,0	3,0	555 520	1500
M6	HUPX30	0,5-3,0	21,5	9,0	9,0	12,0	1,5	6,6	556 470	750
M8	HUPX30	0,5-3,0	23,5	11,0	11,0	15,0	1,5	9,6	558 260	500

M10: programme in progress

All dimensions in mm - Technical data subject to modification
Tolerances and characteristics see chapter 'Technical Information'





Stainless Steel 316

(contains > 2% Molybden)

Semi-hexagonal shank
Low profile head
Open end

HUKO / HSKO

extra high
corrosion resistance

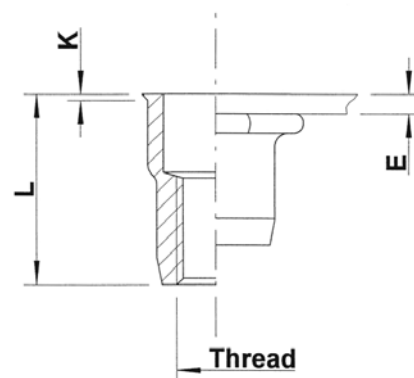
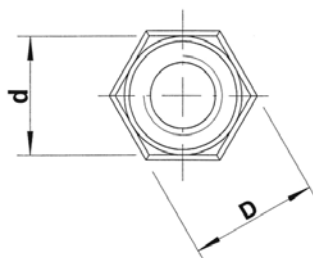
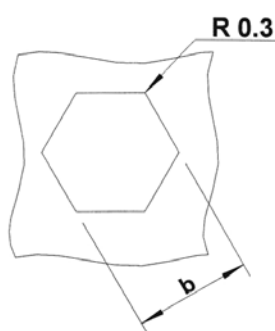

THREAD	TYPE	E = grip	L	b ^{+0,1} = hex hole	d = hex shank	D = hex head	K	kg/1000	ORDER CODE	BOX Q
M4	HUKO20	0,5-2,0	11,0	6,0	6,0	6,5	0,5	1,2	554 600	3000
M5	HUKO30	0,5-3,0	12,0	7,0	7,0	7,5	0,5	1,5	555 600	5000
M6	HUKO30	0,5-3,0	14,5	9,0	9,0	9,5	0,5	3,3	556 500	1000
M8	HUKO30	0,5-3,0	16,0	11,0	11,0	11,5	0,5	4,9	558 300	2000
M10	HSKO35	0,8-3,5	21,0	13,0	13,0	13,5	0,7	8,6	550 640	500
	HSKO60	3,5-6,0	23,5					9,3	550 645	300

All dimensions in mm - Technical data subject to modification
Tolerances and characteristics see chapter 'Technical Information'





Stainless Steel 316

(contains > 2% Molybden)

Semi-hexagonal shank
Low profile head
Closed end

HUKX

extra high
corrosion resistance

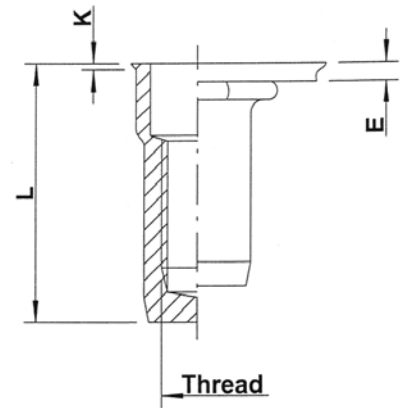
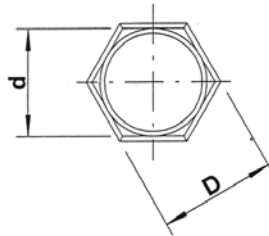
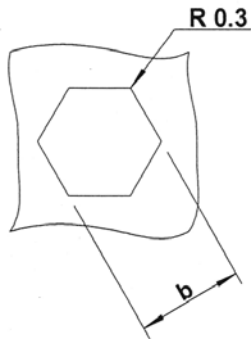

THREAD	TYPE	E = grip	L	b ^{+0,1} = hex hole	d = hex shank	D = hex head	K	kg/1000	ORDER CODE	BOX Q
M4	HUKX20	0,5-2,0	15,5	6,0	6,0	6,5	0,5	1,8	554 620	2500
M5	HUKX30	0,5-3,0	18,0	7,0	7,0	7,5	0,5	2,7	555 620	2000
	HUKX50	3,0-5,5	20,5					3,0	555 640	1500
M6	HUKX30	0,5-3,0	21,5	9,0	9,0	9,5	0,5	5,7	556 540	1000
M8	HUKX30	0,5-3,0	24,0	11,0	11,0	11,5	0,5	8,7	558 320	500
	HUKX55	3,0-5,5	26,5					9,1	558 340	500

M10: programme in progress

All dimensions in mm - Technical data subject to modification
Tolerances and characteristics see chapter 'Technical Information'





Stainless Steel 316

(contains > 2% Molybden)

Semi-hexagonal shank
Flat head with underhead seal
Closed end

HX

watertight
10 bar (IP68)

extra high
corrosion resistance

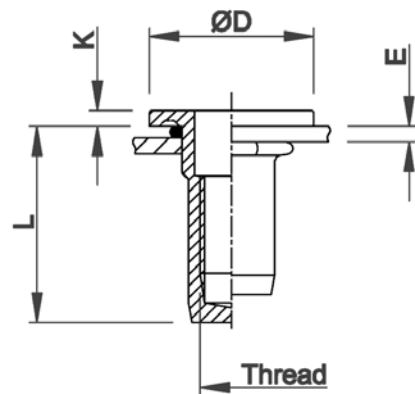
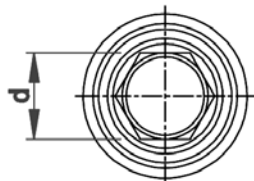
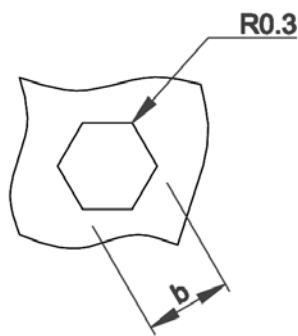

THREAD	TYPE	E = grip	L	b ^{+0,1} = hex hole	d = hex shank	D	K	kg/1000	ORDER CODE	BOX Q
M5	HX3001	0,5-3,0	19,0	7,0	7,0	13,5	1,5	3,8	555 905*	2500
M6	HX3001	0,5-3,0	21,5	9,0	9,0	16,0	1,5	7,5	556 903*	1250
M8	HX3001	0,5-3,0	25,0	11,0	11,0	21,0	2,0	13,1	558 902*	500

* **Non-stock item:** minimum order quantity required after depletion of stock

All dimensions in mm - Technical data subject to modification

Tolerances and characteristics see chapter 'Technical Information'

General and technical information (seal and storage): see [pg 58](#) and [pg 74](#)





Steel

Round shank
Flat head
Open end

Zinktop, Cr^{VI}- free (A)
Zinc plated, yellow passivated (B)

UPO / SPO

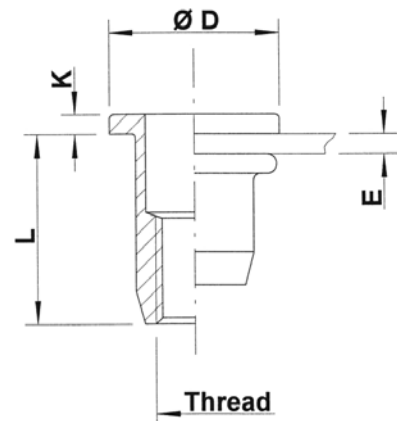
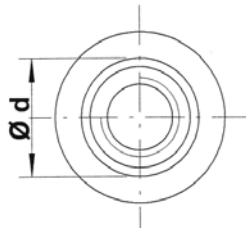
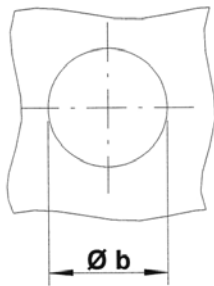

THREAD	TYPE	E = grip	L	b ^{+0,1} = drill dia	d = shank dia	D	K	kg/1000	ORDER CODE (A)	ORDER CODE (B)	BOX Q
M3	UPO20	0,5-2,0	9,75	5,0	5,0	8,0	0,75	1,0	523 029	523 020*	10000
	UPO30	2,0-3,0	10,75						523 049	523 040*	10000
M4	UPO30	0,5-3,0	10,75	6,0	6,0	10,0	0,75	1,5	524 029	524 020	5000
	UPO45	3,0-4,5	12,25						524 049	524 040*	5000
M5	UPO30	0,5-3,0	12,0	7,0	7,0	11,0	1,0	2,1	525 029	525 020	4000
	UPO55	3,0-5,5	15,0						525 049	525 040*	3000
M6	UPO30	0,5-3,0	14,5	9,0	9,0	13,0	1,5	4,3	526 029	526 020	2000
	UPO55	3,0-5,5	16,5						526 069	526 060	2000
	UPO80	5,5-8,0	19,0						526 089	526 080*	1500
M8	UPO30	0,5-3,0	16,0	11,0	11,0	16,0	1,5	6,4	528 022	528 020	1250
	UPO55	3,0-5,5	18,5						528 069	528 060	1200
	UPO80	5,5-8,0	21,5						528 089	528 080*	1000
M10	UPO35	0,8-3,5	19,75	12,5	12,4	18,5	2,25	9,8	520 029	520 020	750
	UPO60	3,5-6,0	22,75						520 049	520 040*	700
M10	SPO35	0,8-3,5	21,0	13,0	13,0	19,0	2,0	11,4	520 609	520 600*	750
	SPO60	3,5-6,0	24,0						520 629	520 620*	500
M12	UPO40	1,0-4,0	25,0	16,0	16,0	23,0	2,0	19,6	522 029	522 020*	400
	UPO70	4,0-7,0	28,0						522 059	522 050*	300

* Non-stock item: minimum order quantity required after depletion of stock

All dimensions in mm - Technical data subject to modification
Tolerances and characteristics see chapter 'Technical Information'





Steel

Round shank
Flat head
Closed end

Zinktop, Cr^{VI}- free (A)
Zinc plated, yellow passivated (B)

UPX

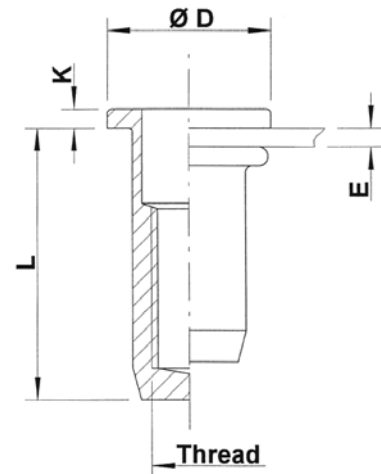
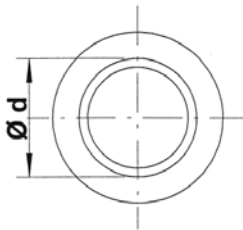
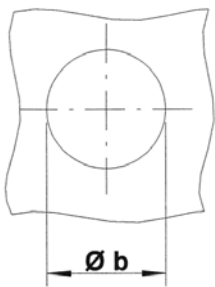

THREAD	TYPE	E = grip	L	b ^{+0,1} = drill dia	d = shank dia	D	K	kg/1000	ORDER CODE (A)	ORDER CODE (B)	BOX Q
M4	UPX30	0,5-3,0	14,75	6,0	6,0	10,0	0,75	2,1	524 189	524 180*	5000
	UPX45	3,0-4,5	16,25					2,1	524 229*	524 220*	4000
M5	UPX30	0,5-3,0	18,0	7,0	7,0	11,0	1,0	3,4	525 169	525 160*	2500
	UPX55	3,0-5,5	20,5					3,6	525 189*	525 180*	2500
M6	UPX30	0,5-3,0	21,5	9,0	9,0	13,0	1,5	6,8	526 169	526 160*	1500
	UPX55	3,0-5,5	24,5					7,5	526 209	526 200*	1250
M8	UPX30	0,5-3,0	22,5	11,0	11,0	16,0	1,5	9,7	528 189	528 180*	1000
	UPX55	3,0-5,5	25,5					10,9	528 209	528 200*	750

* **Non-stock item:** minimum order quantity required after depletion of stock

All dimensions in mm - Technical data subject to modification
Tolerances and characteristics see chapter 'Technical Information'





Steel

Round shank
Countersunk head
Open end

Zinktop, Cr^{VI}- free (A)
Zinc plated, yellow passivated (B)

UFO

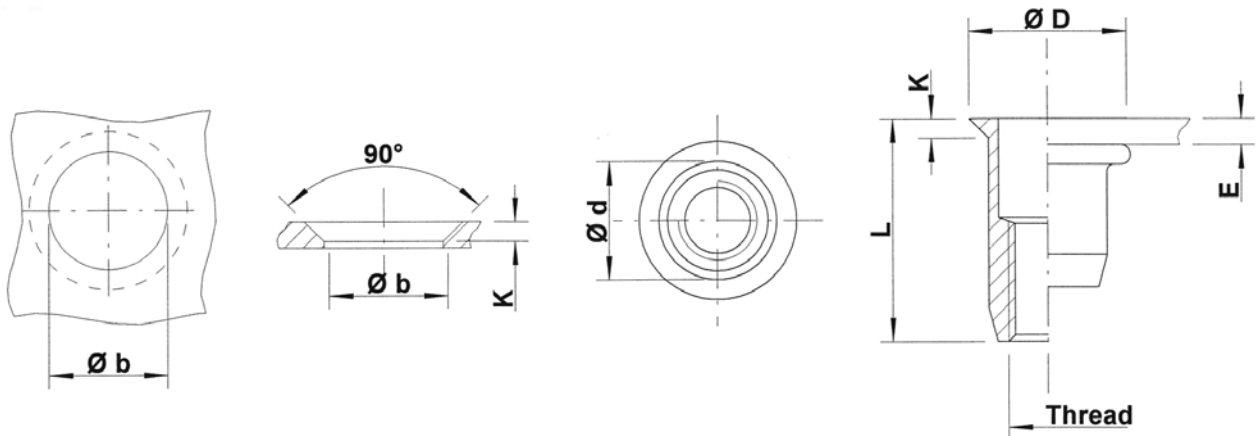

THREAD	TYPE	E = grip	L	b ^{+0,1} = drill dia	d = shank dia	D	K	kg/1000	ORDER CODE (A)	ORDER CODE (B)	BOX Q
M3	UFO35	1,7-3,5	11,25	5,0	5,0	8,0	1,5	1,1	523 209	523 200*	10000
M4	UFO35	1,7-3,5	11,5	6,0	6,0	9,0	1,5	1,3	524 309	524 300	7500
	UFO50	3,5-5,0	13,0					1,5	524 329	524 320*	5000
M5	UFO40	1,7-4,0	13,0	7,0	7,0	10,0	1,5	2,0	525 269	525 260	5000
	UFO65	4,0-6,5	16,0					2,3	525 289	525 280*	4000
M6	UFO45	1,7-4,5	17,0	9,0	9,0	12,0	1,5	4,2	526 309	526 300	2000
	UFO65	4,5-6,5	19,0					4,7	526 329	526 320*	2000
M8	UFO45	1,7-4,5	19,0	11,0	11,0	14,0	1,5	6,3	528 269	528 260	1250
	UFO65	4,5-6,5	21,0					7,0	528 289	528 280*	1250
M10	UFO45	1,7-4,5	21,0	12,5	12,4	15,4	1,5	7,6	520 229	520 220*	1000
	UFO65	4,5-6,5	23,0					8,2	520 249	520 240*	750
M12	UFO45	2,0-4,5	26,0	16,0	16,0	19,0	1,8	16,9	522 269	522 260*	500
	UFO75	4,5-7,5	29,0					18,0	522 289	522 280*	400

* **Non-stock item:** minimum order quantity required after depletion of stock

All dimensions in mm - Technical data subject to modification
Tolerances and characteristics see chapter 'Technical Information'





Steel

Countersunk head
Round shank
Closed end

Zinktop, Cr^{VI} - free (A)
Zinc plated, yellow passivated (B)

UFX

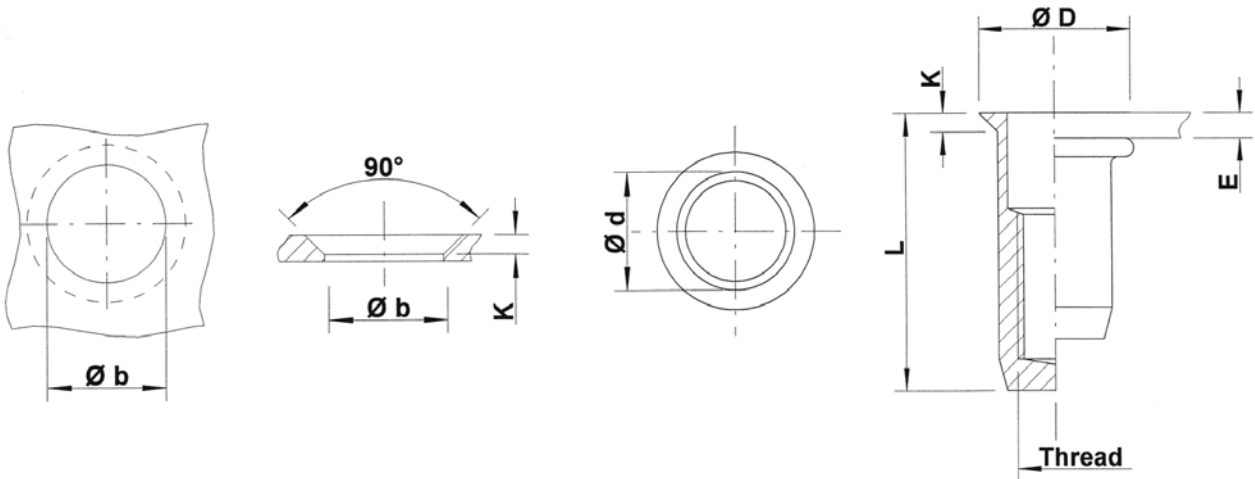

THREAD	TYPE	E = grip	L	b ^{+0,1} = drill dia	d = shank dia	D	K	kg/1000	ORDER CODE (A)	ORDER CODE (B)	BOX Q
M4	UFX35	1,7-3,5	15,5	6,0	6,0	9,0	1,5	2,0	524 449	524 440*	5000
	UFX50	3,5-5,0	17,0					2,2	524 469*	524 460*	5000
M5	UFX40	1,7-4,0	18,0	7,0	7,0	10,0	1,5	3,0	525 389	525 380*	3000
	UFX65	4,0-6,5	20,5					3,4	525 409*	525 400*	3000
M6	UFX45	1,7-4,5	22,0	9,0	9,0	12,0	1,5	6,1	526 409	526 400*	1500
	UFX65	4,5-6,5	24,0					6,5	526 429*	526 420*	1500
M8	UFX45	1,7-4,5	25,0	11,0	11,0	14,0	1,5	9,2	528 369	528 360*	1000
	UFX65	4,5-6,5	28,0					10,1	528 389*	528 380*	750

* **Non-stock item:** minimum order quantity required after depletion of stock

All dimensions in mm - Technical data subject to modification
Tolerances and characteristics see chapter 'Technical Information'





Steel

Round shank
Low profile head
Open end

Zinktop, Cr^{VI} - free (A)
Zinc plated, yellow passivated (B)

UKO

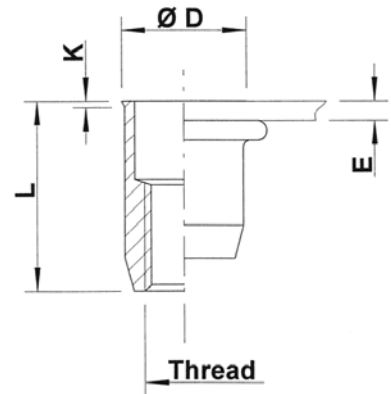
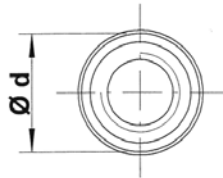
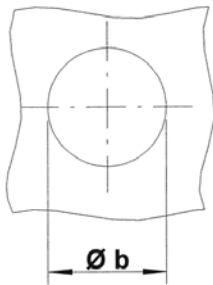

THREAD	TYPE	E = grip	L	b ^{+0,1} = drill dia	d = shank dia	D	K	kg/1000	ORDER CODE (A)	ORDER CODE (B)	BOX Q
M4	UKO30	0,5-3,0	10,75	6,0	6,0	6,5	0,5	1,1	524 529	524 520	10000
	UKO50	3,0-5,0	12,75						524 539*	524 530*	7500
M5	UKO30	0,5-3,0	12,0	7,0	7,0	7,5	0,5	1,6	525 469	525 460	5000
	UKO55	3,0-5,5	15,0						525 489	525 480*	4000
M6	UKO30	0,5-3,0	14,5	9,0	9,0	9,5	0,5	3,4	526 469	526 460	3000
	UKO55	3,0-5,5	16,5						526 489	526 480*	2500
M8	UKO30	0,5-3,0	16,0	11,0	11,0	11,5	0,5	5,0	528 449	528 440	2000
	UKO55	3,0-5,5	18,5						528 459	528 450*	1500
M10	UKO35	0,8-3,5	19,5	12,5	12,4	12,9	0,5	6,7	520 459	520 450*	1250

* **Non-stock item:** minimum order quantity required after depletion of stock

All dimensions in mm - Technical data subject to modification
Tolerances and characteristics see chapter 'Technical Information'





Steel

Round shank
Low profile head
Closed end

Zinktop, Cr^{VI}- free (A)
Zinc plated, yellow passivated (B)

UKX

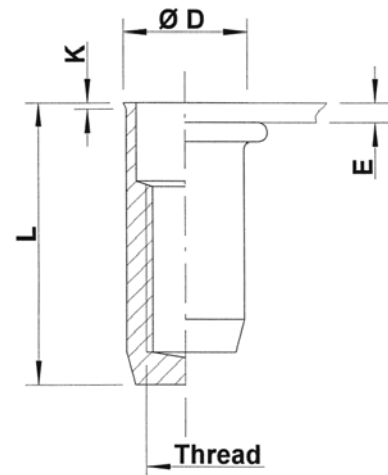
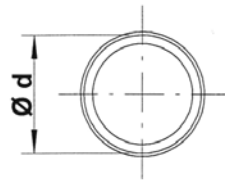
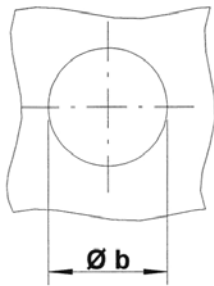

THREAD	TYPE	E = grip	L	b ^{+0,1} = drill dia	d = shank dia	D	K	kg/1000	ORDER CODE (A)	ORDER CODE (B)	BOX Q
M4	UKX30	0,5-3,0	15,0	6,0	6,0	6,5	0,5	1,8	524 579	524 570*	5000
M5	UKX30	0,5-3,0	18,0	7,0	7,0	7,5	0,5	2,8	525 559	525 550*	4000
M6	UKX30	0,5-3,0	21,5	9,0	9,0	9,5	0,5	5,8	526 519	526 510*	2000
M8	UKX30	0,5-3,0	22,5	11,0	11,0	11,5	0,5	8,3	528 479	528 470*	1250

* **Non-stock item:** minimum order quantity required after depletion of stock

All dimensions in mm - Technical data subject to modification
Tolerances and characteristics see chapter 'Technical Information'





Steel

Round shank
Anti-turn head
Open end

Zinktop, Cr^{VI} - free

ATO

**repair solution:
extra high
torque-to-turn values**

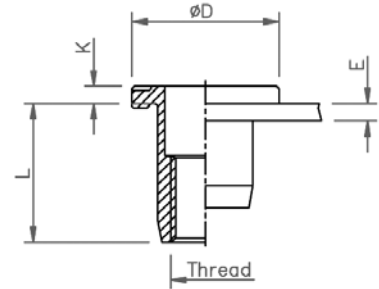
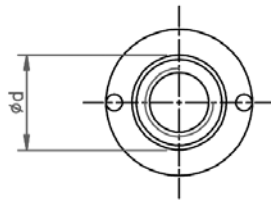
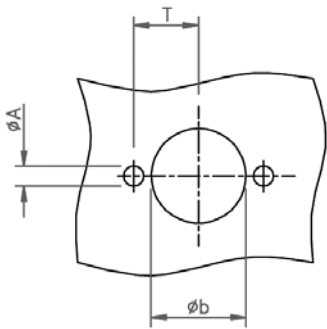

THREAD	TYPE	E = grip	L	b ^{+0,1} = drill dia	d = shank dia	D	K	A	T	kg/1000	ORDER CODE	BOX Q
M6	ATO30	0,5-3,0	14,5	9,0	9,0	14,0	1,5	1,8	6,25	4,6	526 1029*	1750
M8	ATO30	0,5-3,0	16,0	11,0	11,0	17,0	2,0	2,3	7,5	7,4	528 1022*	1200
M10	ATO35	0,8-3,5	21,0	13,0	13,0	19,0	2,0	3,0	8,75	11,4	520 1609*	750

Tool to position Ø A:

M6	AT 206
M8	AT 208
M10	AT 210



Samples available from stock - general info [see pg 60](#)

All dimensions in mm - Technical data subject to modification
Tolerances and characteristics see chapter 'Technical Information'





Steel

Knurled shank
Flat head
Open end

Zinktop, Cr^{VI} - free

UPO KN

improved
nominal knurl

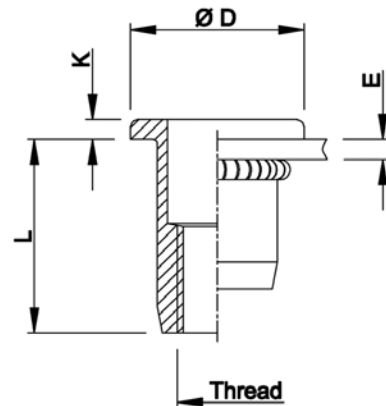
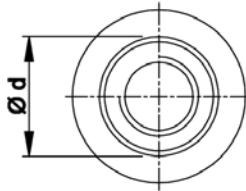
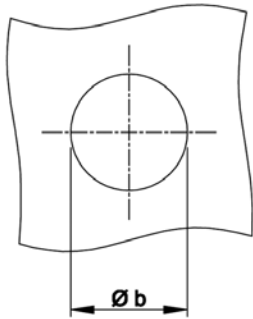

THREAD	TYPE	E = grip	L	b ^{+0,1} = drill dia	d = shank dia	D	K	kg/1000	ORDER CODE	BOX Q
M4	UPO30 KN	0,5-3,0	10,75	6,0	6,0	10,0	0,75	1,5	524 0297*	5000
	UPO45 KN	3,0-4,5	12,25					1,5	524 0497*	5000
M5	UPO30 KN	0,5-3,0	12,0	7,0	7,0	11,0	1,0	2,1	525 0297*	4000
	UPO55 KN	3,0-5,5	15,0					2,5	525 0497*	3000
M6	UPO30 KN	0,5-3,0	14,5	9,0	9,0	13,0	1,5	4,3	526 0297	2000
	UPO55 KN	3,0-5,5	16,5					4,7	526 0697*	2000
M8	UPO30 KN	0,5-3,0	16,0	11,0	11,0	16,0	1,5	6,4	528 0227	1250
	UPO55 KN	3,0-5,5	18,5					7,0	528 0697*	1250

* **Non-stock item:** minimum order quantity required after depletion of stock

KN programme in progress (also UFO version)

All dimensions in mm - Technical data subject to modification
Tolerances and characteristics see chapter 'Technical Information'





Steel

Knurled shank
Low profile head
Open end

Zinktop, Cr^{VI}- free

UKO KN

improved
nominal knurl

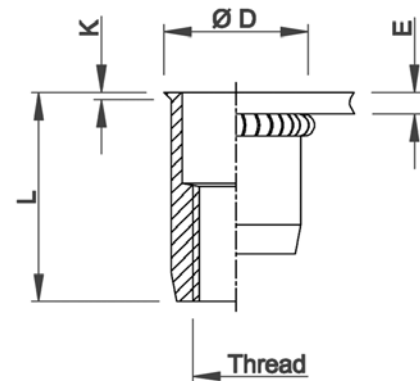
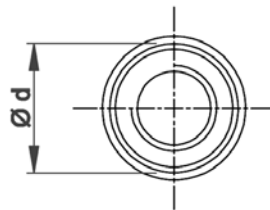

THREAD	TYPE	E = grip	L	b ^{+0,1} = drill dia	d = shank dia	D	K	kg/1000	ORDER CODE	BOX Q
M4	UKO30 KN	0,5-3,0	10,75	6,0	6,0	6,5	0,5	1,1	524 5297	10000
	UKO50 KN	3,0-5,0	12,75						524 5397*	7500
M5	UKO30 KN	0,5-3,0	12,0	7,0	7,0	7,5	0,5	1,6	525 4697	5000
	UKO55 KN	3,0-5,5	15,0						525 4897*	4000
M6	UKO30 KN	0,5-3,0	14,5	9,0	9,0	9,5	0,5	3,4	526 4697	3000
	UKO55 KN	3,0-5,5	16,5						526 4897*	2500
M8	UKO30 KN	0,5-3,0	16,0	11,0	11,0	11,5	0,5	5,0	528 4497*	2000
	UKO55 KN	3,0-5,5	18,5						528 4597*	1500

* **Non-stock item:** minimum order quantity required after depletion of stock

KN programme in progress (also UFO version)

All dimensions in mm - Technical data subject to modification
Tolerances and characteristics see chapter 'Technical Information'





Steel

Hexagonal shank
Flat head
Open end

Zinktop, Cr^{VI}- free (A)
Zinc plated, yellow passivated (B)

HUPO / HSPO

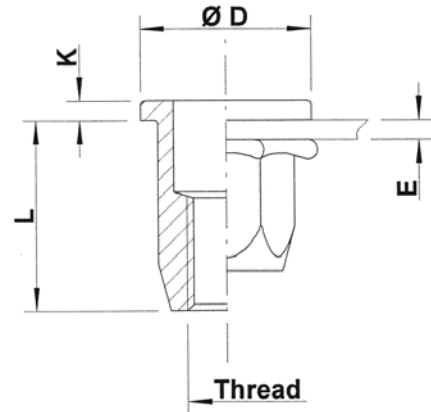
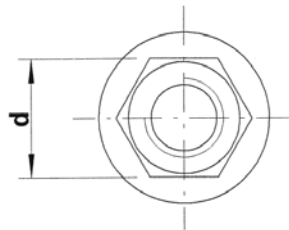
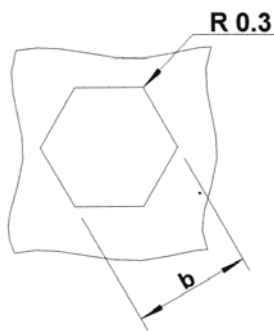

THREAD	TYPE	E = grip	L	b ^{+0,1} = hex hole	d = hex shank	D	K	kg/1000	ORDER CODE (A)	ORDER CODE (B)	BOX Q
M4	HUPO20	0,5-2,0	10,0	6,0	6,0	9,0	1,0	1,4	524 589	524 580	7000
M5	HUPO30	0,5-3,0	13,0	7,0	7,0	10,0	1,0	2,3	525 569	525 560	4000
M6	HUPO30	0,5-3,0	14,5	9,0	9,0	13,0	1,5	4,7	526 529	526 520	2000
	HUPO55	3,0-5,5	16,5					4,8	526 549	526 540	1750
M8	HUPO30	0,5-3,0	16,5	11,0	11,0	16,0	1,5	7,0	528 482	528 480	1200
	HUPO55	3,0-5,5	19,0					7,5	528 509	528 500	1000
	HUPO80	5,5-8,0	22,0					8,1	528 609	528 600*	750
M10	HSPO35	0,8-3,5	21,0	13,0	13,0	19,0	2,0	11,6	520 649	520 640	700
	HSPO60	3,5-6,0	23,5					12,3	520 659	520 650*	500

* **Non-stock item:** minimum order quantity required after depletion of stock

All dimensions in mm - Technical data subject to modification
Tolerances and characteristics see chapter 'Technical Information'





Steel

Semi-hexagonal shank
Flat head
Open end

Zinktop, Cr^{VI}- free (A)
Zinc plated, yellow passivated (B)

HUPO

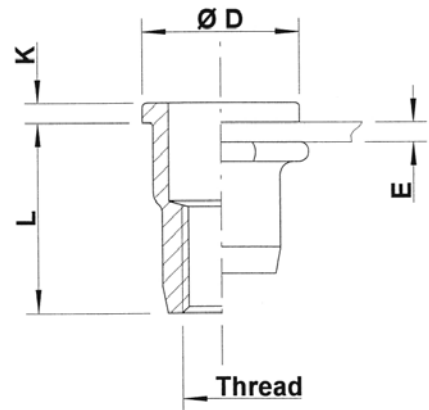
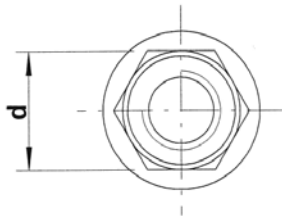
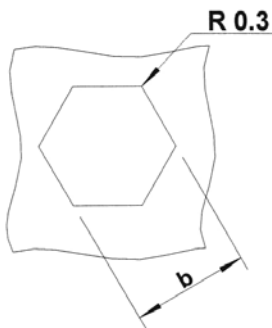

THREAD	TYPE	E = grip	L	b ^{+0,1} = hex hole	d = hex shank	D	K	kg/1000	ORDER CODE (A)	ORDER CODE (B)	BOX Q
M12	HUPO40	1,0-4,0	25,0	16,0	16,0	23,0	2,0	19,6	522 509	522 500*	350

*All dimensions in mm - Technical data subject to modification
Tolerances and characteristics see chapter 'Technical Information'*





Steel

Hexagonal shank
Flat head
Closed end

Zinktop, Cr^{VI} - free (A)
Zinc plated, yellow passivated (B)

HUPX / HSPX

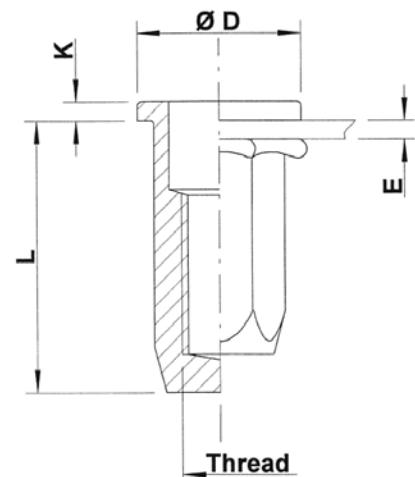
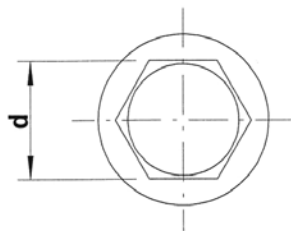
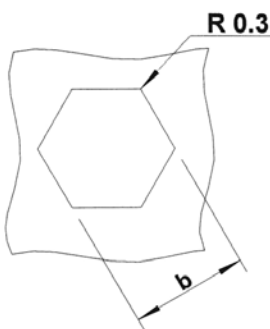

THREAD	TYPE	E = grip	L	b ^{+0,1} = hex hole	d = hex shank	D	K	kg/1000	ORDER CODE (A)	ORDER CODE (B)	BOX Q
M4	HUPX20	0,5-2,0	14,5	6,0	6,0	9,0	1,0	2,2	524 609	524 600*	5000
M5	HUPX30	0,5-3,0	19,0	7,0	7,0	10,0	1,0	3,6	525 589	525 580*	2500
	HUPX55	3,0-5,5	21,5					3,9	525 599*	525 590*	2500
M6	HUPX30	0,5-3,0	21,5	9,0	9,0	13,0	1,5	7,4	526 569	526 560	1500
	HUPX55	3,0-5,5	23,5					7,6	526 579*	526 570*	1500
M8	HUPX30	0,5-3,0	24,5	11,0	11,0	16,0	1,5	11,6	528 529	528 520	750
	HUPX55	3,0-5,5	27,0					12,2	528 539	528 530*	700
M10	HSPX35	0,8-3,5	31,0	13,0	13,0	19,0	2,0	19,0	520 654	520 655	400
	HSPX60	3,5-6,0	33,5					19,4	520 658	520 656*	400

* **Non-stock item:** minimum order quantity required after depletion of stock

All dimensions in mm - Technical data subject to modification
Tolerances and characteristics see chapter 'Technical Information'





Steel

Hexagonal shank
Low profile head
Open end

Zinktop, Cr^{VI}- free (A)
Zinc plated, yellow passivated (B)

HUKO / HSKO

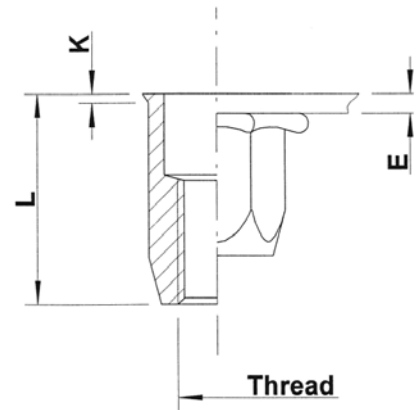
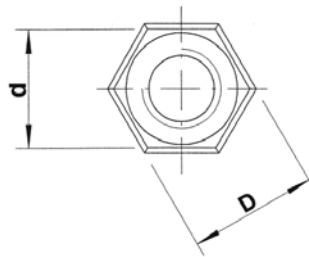
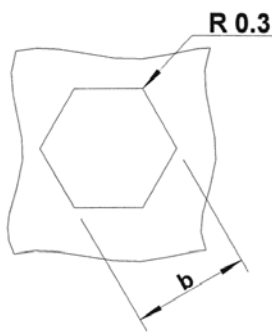

THREAD	TYPE	E = grip	L	b ^{+0,1} = hex hole	d = hex shank	D = hex head	K	kg/1000	ORDER CODE (A)	ORDER CODE (B)	BOX Q
M4	HUKO20	0,5-2,0	11,0	6,0	6,0	6,6	0,6	1,2	524 629	524 620	7500
M5	HUKO30	0,5-3,0	14,0	7,0	7,0	7,7	0,6	2,0	525 609	525 600	5000
	HUKO55	3,0-5,5	16,5					2,3	525 629	525 620*	4000
M6	HUKO30	0,5-3,0	16,0	9,0	9,0	9,8	0,7	4,2	526 589	526 580	2500
	HUKO55	3,0-5,5	18,5					4,6	526 609	526 600	2000
M8	HUKO30	0,5-3,0	18,0	11,0	11,0	11,8	0,7	6,2	528 549	528 540	1250
	HUKO55	3,0-5,5	20,5					6,9	528 569	528 560	1250
M10	HSKO35	0,8-3,5	23,0	13,0	13,0	13,8	0,7	10,5	520 669	520 660*	750
	HSKO60	3,5-6,0	25,5					11,0	520 679	520 670*	700

* **Non-stock item:** minimum order quantity required after depletion of stock

All dimensions in mm - Technical data subject to modification
Tolerances and characteristics see chapter 'Technical Information'





Steel

Hexagonal shank
Low profile head
Closed end

Zinktop, Cr^{VI} - free (A)
Zinc plated, yellow passivated (B)

HUKX

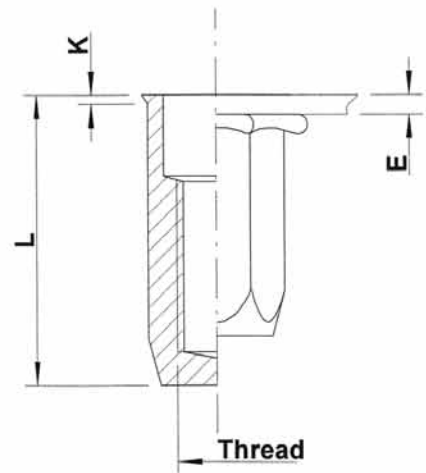
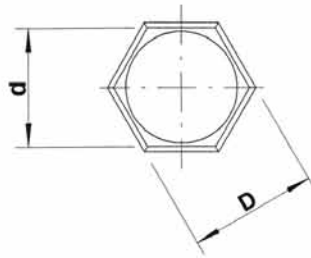
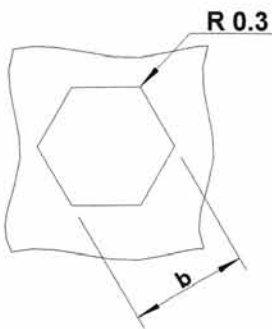

THREAD	TYPE	E = grip	L	b ^{+0,1} = hex hole	d = hex shank	D = hex head	K	kg/1000	ORDER CODE (A)	ORDER CODE (B)	BOX Q
M4	HUKX20	0,5-2,0	15,5	6,0	6,0	6,6	0,6	2,0	524 649	524 640	5000
M5	HUKX30	0,5-3,0	20,0	7,0	7,0	7,7	0,6	3,3	525 649	525 640	3000
M6	HUKX30	0,5-3,0	22,0	9,0	9,0	9,8	0,7	6,6	526 629	526 620	1750
M8	HUKX30	0,5-3,0	25,0	11,0	11,0	11,8	0,7	10,5	528 589	528 580	1000

*All dimensions in mm - Technical data subject to modification
Tolerances and characteristics see chapter 'Technical Information'*





Steel

Hexagonal shank
Flat head with underhead seal
Closed end

Zinktop, Cr^{VI} - free (A)
Zinc plated, yellow passivated (B)

HX

watertight
10 bar (IP68)

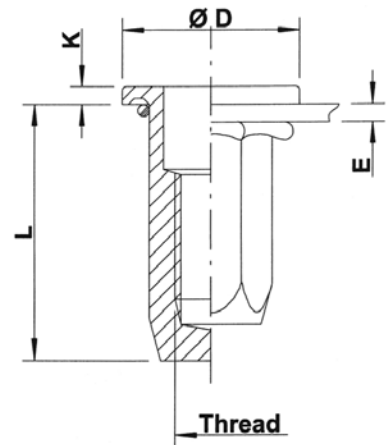
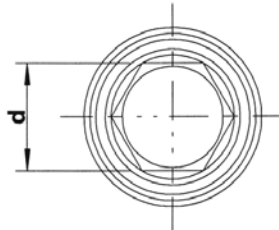
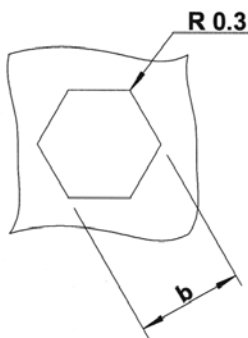

THREAD	TYPE	E = grip	L	b ^{+0,1} = hex hole	d = hex shank	D	K	kg/1000	ORDER CODE (A)	ORDER CODE (B)	BOX Q
M5	HX3001	0,5-3,0	19,0	7,0	7,0	12,5	1,5	4,3	525 925*	525 916*	2500
M6	HX3001	0,5-3,0	21,5	9,0	9,0	15,0	1,5	8,0	526 942	526 920*	1250
M8	HX3001	0,5-3,0	26,7	11,0	11,0	20,0	2,0	14,8	528 935	528 924*	500

* **Non-stock item:** minimum order quantity required after depletion of stock

All dimensions in mm - Technical data subject to modification
Tolerances and characteristics see chapter 'Technical Information'

Technical information about seal and storage: [see pg 74](#)
New: stainless HX Tubtara see [pg 20](#), [pg 32](#) and [pg 58](#)





Steel

Splined shank
Flat head
Open end

Zinktop, Cr^{VI} - free (A)
Zinc plated, yellow passivated (B)

UPO RS

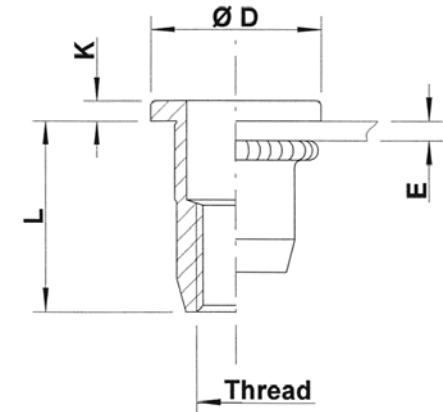
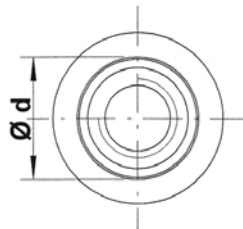
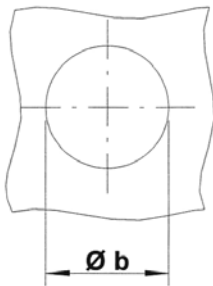

THREAD	TYPE	E = grip	L	b ^{+0,1} = drill dia	d = splined shank	D	K	kg/1000	ORDER CODE (A)	ORDER CODE (B)	BOX Q
M4	UPO30 RS	0,5-3,0	10,75	6,4	6,3	10,0	0,75	1,5	524 709	524 700	5000
	UPO45 RS	3,0-4,5	12,25						524 729*	524 720*	5000
M5	UPO30 RS	0,5-3,0	12,0	7,4	7,3	11,0	1,0	2,2	525 709	525 700	4000
	UPO55 RS	3,0-5,5	15,0						525 729	525 720*	3000
M6	UPO30 RS	0,5-3,0	14,5	9,4	9,3	13,0	1,5	4,4	526 709	526 700	2000
	UPO55 RS	3,0-5,5	16,5						526 729	526 720*	2000
M8	UPO30 RS	0,5-3,0	16,0	11,5	11,4	16,0	1,5	6,5	528 709	528 700	1250
	UPO55 RS	3,0-5,5	18,5						528 729	528 720*	1200
M10	UPO35 RS	0,8-3,5	19,75	13,0	12,9	18,5	2,25	10,0	520 709	520 700	750
	UPO60 RS	3,5-6,0	22,75						520 729	520 720*	700

* **Non-stock item:** minimum order quantity required after depletion of stock

All dimensions in mm - Technical data subject to modification
Tolerances and characteristics see chapter 'Technical Information'





Steel

Splined shank
Countersunk head
Open end

Zinktop, Cr^{VI} - free (A)
Zinc plated, yellow passivated (B)

UFO RS

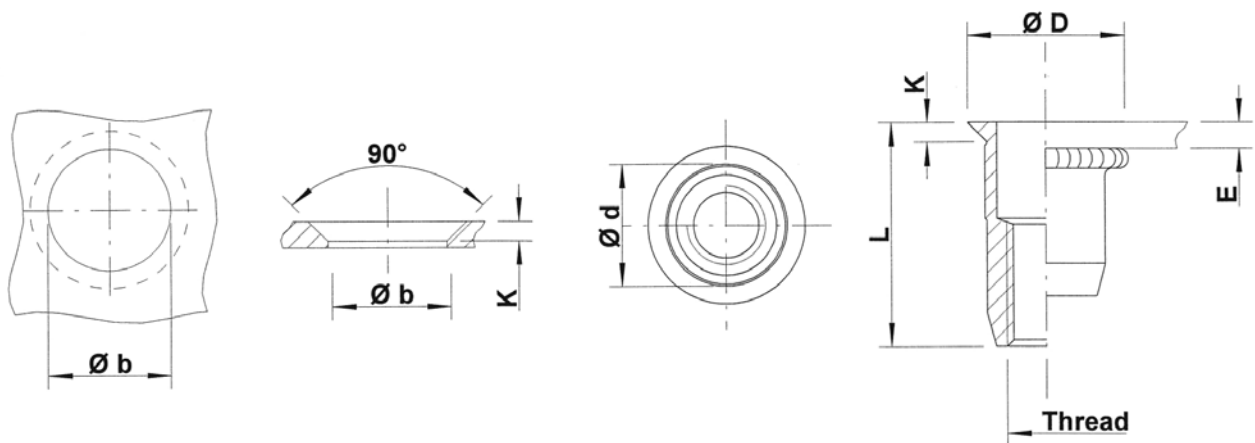

THREAD	TYPE	E = grip	L	b ^{+0,1} = drill dia	d = splined shank	D	K	kg/1000	ORDER CODE (A)	ORDER CODE (B)	BOX Q
M4	UFO35 RS	1,7-3,5	11,5	6,4	6,3	9,0	1,5	1,4	524 749	524 740*	7500
	UFO50 RS	3,5-5,0	13,0					1,5	524 769*	524 760*	5000
M5	UFO40 RS	1,7-4,0	13,0	7,4	7,3	10,0	1,5	2,1	525 749	525 740*	5000
	UFO65 RS	4,0-6,5	16,0					2,4	525 769*	525 760*	4000
M6	UFO45 RS	1,7-4,5	17,0	9,4	9,3	12,0	1,5	4,4	526 769	526 760*	2000
	UFO65 RS	4,5-6,5	19,0					4,7	526 789	526 780*	2000
M8	UFO45 RS	1,7-4,5	19,0	11,5	11,4	14,0	1,5	6,4	528 749	528 740	1250
	UFO65 RS	4,5-6,5	21,0					6,8	528 769	528 760*	1250
M10	UFO45 RS	1,7-4,5	21,0	13,0	12,9	15,4	1,5	7,9	520 749	520 740*	750
	UFO65 RS	4,5-6,5	23,0					8,5	520 769	520 760*	750

* **Non-stock item:** minimum order quantity required after depletion of stock

All dimensions in mm - Technical data subject to modification
Tolerances and characteristics see chapter 'Technical Information'





Aluminium

Round shank
Flat head
Open end

UPO

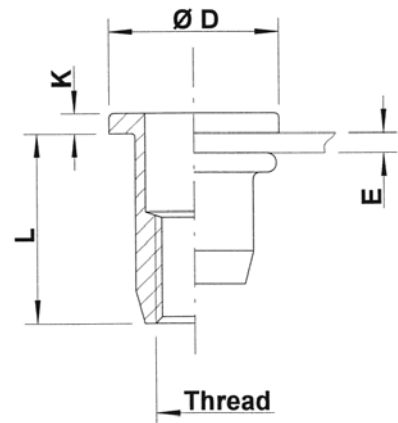
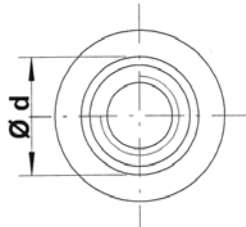
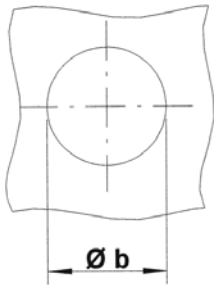

THREAD	TYPE	E = grip	L	b ^{+0,1} = drill dia	d = shank dia	D	K	kg/1000	ORDER CODE	BOX Q
M3	UPO20	0,5-2,0	9,75	5,0	5,0	8,0	0,75	0,4	513 050	10000
	UPO30	2,0-3,0	10,75						513 100	10000
M4	UPO30	0,5-3,0	10,75	6,0	6,0	10,0	0,75	0,5	514 025	5000
	UPO45	3,0-4,5	12,25						514 050	5000
M5	UPO30	0,5-3,0	12,0	7,0	7,0	11,0	1,0	0,7	515 025	4000
	UPO55	3,0-5,5	15,0						515 050	3000
M6	UPO30	0,5-3,0	14,5	9,0	9,0	13,0	1,5	1,5	516 025	2000
	UPO55	3,0-5,5	16,5						516 075	2000
	UPO80	5,5-8,0	19,0						516 090*	1500
M8	UPO30	0,5-3,0	16,0	11,0	11,0	16,0	1,5	2,2	518 025	1250
	UPO55	3,0-5,5	18,5						518 050	1250
	UPO80	5,5-8,0	21,5						518 055*	1000
M10	UPO35	0,8-3,5	19,75	12,5	12,4	18,5	2,25	3,3	510 025	750
	UPO60	3,5-6,0	22,75						510 050*	700

* **Non-stock item:** minimum order quantity required after depletion of stock

All dimensions in mm - Technical data subject to modification
Tolerances and characteristics see chapter 'Technical Information'





Aluminium

Round shank
Flat head
Closed end

UPX

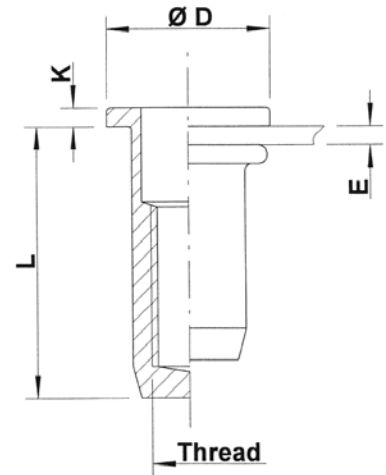
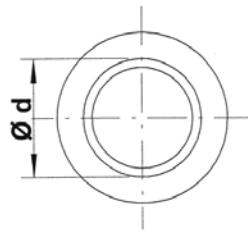
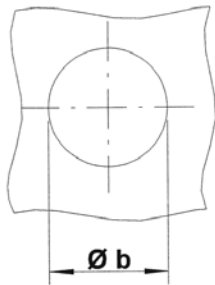

THREAD	TYPE	E = grip	L	b ^{+0,1} = drill dia	d = shank dia	D	K	kg/1000	ORDER CODE	BOX Q
M3	UPX20	0,5-2,0	13,25	5,0	5,0	8,0	0,75	0,5	513 400*	7500
M4	UPX30	0,5-3,0	14,75	6,0	6,0	10,0	0,75	0,7	514 200	5000
	UPX45	3,0-4,5	16,25						514 225*	4000
M5	UPX30	0,5-3,0	18,0	7,0	7,0	11,0	1,0	1,1	515 175	2500
	UPX55	3,0-5,5	20,5						515 200*	2500
M6	UPX30	0,5-3,0	21,5	9,0	9,0	13,0	1,5	2,3	516 175	1500
	UPX55	3,0-5,5	24,5						516 200*	1500
M8	UPX30	0,5-3,0	22,5	11,0	11,0	16,0	1,5	3,5	518 125	750
	UPX55	3,0-5,5	25,5						518 150*	750

* **Non-stock item:** minimum order quantity required after depletion of stock

All dimensions in mm - Technical data subject to modification
Tolerances and characteristics see chapter 'Technical Information'





Aluminium

Round shank
Countersunk head
Open end

UFO

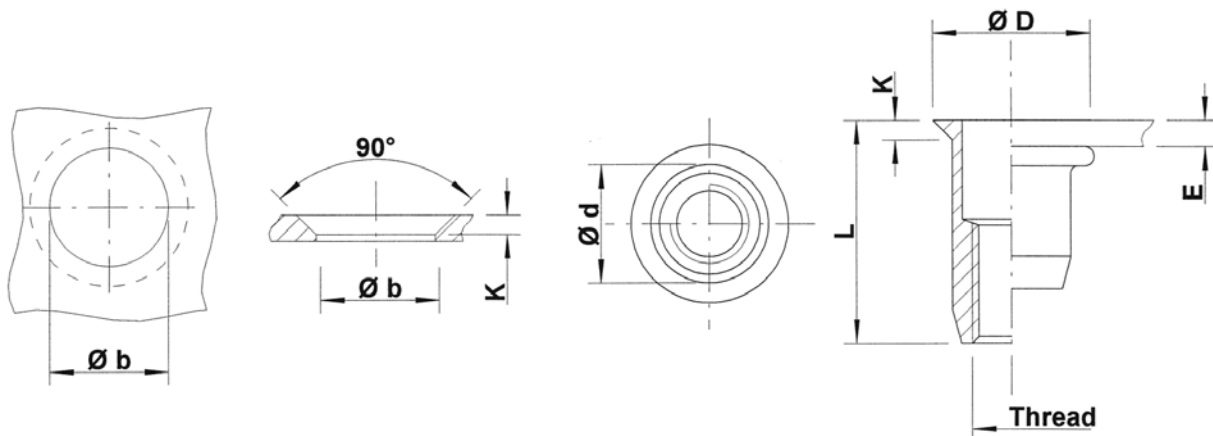

THREAD	TYPE	E = grip	L	b ^{+0,1} = drill dia	d = shank dia	D	K	kg/1000	ORDER CODE	BOX Q
M3	UFO35	1,7-3,5	11,25	5,0	5,0	8,0	1,5	0,4	513 550	10000
M4	UFO35	1,7-3,5	11,5	6,0	6,0	9,0	1,5	0,5	514 350	7500
	UFO50	3,5-5,0	13,0					0,5	514 375	5000
M5	UFO40	1,7-4,0	13,0	7,0	7,0	10,0	1,5	0,7	515 250	5000
	UFO65	4,0-6,5	16,0					0,8	515 275	4000
M6	UFO45	1,7-4,5	17,0	9,0	9,0	12,0	1,5	1,5	516 250	2000
	UFO65	4,5-6,5	19,0					1,6	516 275	2000
M8	UFO45	1,7-4,5	19,0	11,0	11,0	14,0	1,5	2,1	518 175	1250
	UFO65	4,5-6,5	21,0					2,2	518 200	1250
M10	UFO45	1,7-4,5	21,0	12,5	12,4	15,4	1,5	2,5	510 250	1000
	UFO65	4,5-6,5	23,0					2,7	510 275*	1000

* **Non-stock item:** minimum order quantity required after depletion of stock

All dimensions in mm - Technical data subject to modification
Tolerances and characteristics see chapter 'Technical Information'





Aluminium

Round shank
Countersunk head
Closed end

UFX

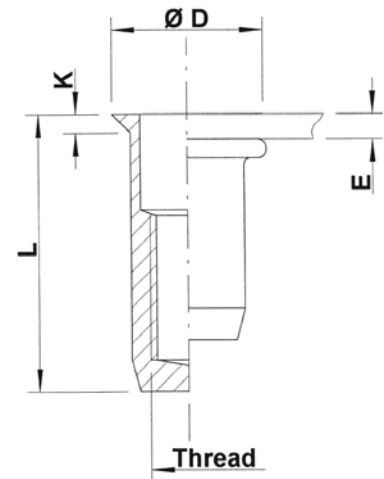
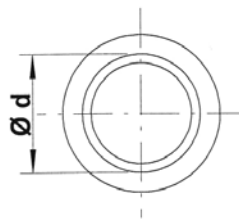
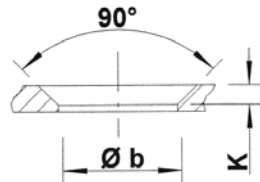
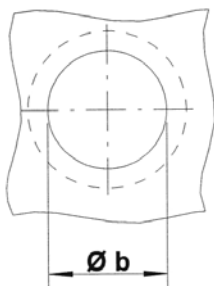

THREAD	TYPE	E = grip	L	$b^{+0,1}$ = drill dia	d = shank dia	D	K	kg/1000	ORDER CODE	BOX Q
M4	UFX35	1,7-3,5	15,5	6,0	6,0	9,0	1,5	0,7	514 450	5000
	UFX50	3,5-5,0	17,0	6,0	6,0	9,0	1,5	0,7	514 475*	5000
M5	UFX40	1,7-4,0	18,0	7,0	7,0	10,0	1,5	1,0	515 375	3000
	UFX65	4,0-6,5	20,5	7,0	7,0	10,0	1,5	1,1	515 400*	3000
M6	UFX45	1,7-4,5	22,0	9,0	9,0	12,0	1,5	2,1	516 400	1500
	UFX65	4,5-6,5	24,0	9,0	9,0	12,0	1,5	2,3	516 425*	1500
M8	UFX45	1,7-4,5	25,0	11,0	11,0	14,0	1,5	3,3	518 325*	1000
	UFX65	4,5-6,5	28,0	11,0	11,0	14,0	1,5	3,7	518 350*	750

* **Non-stock item:** minimum order quantity required after depletion of stock

All dimensions in mm - Technical data subject to modification
Tolerances and characteristics see chapter 'Technical Information'





Aluminium

Round shank
Low profile head
Open end

UKO

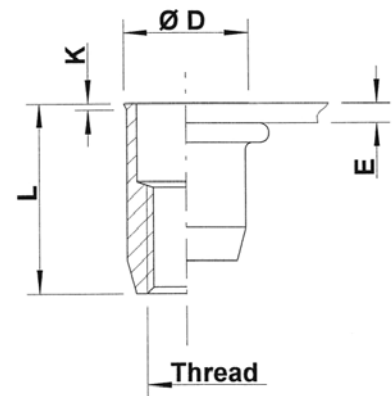
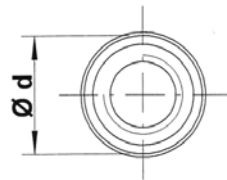
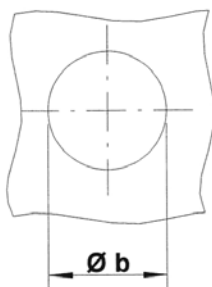

THREAD	TYPE	E = grip	L	b ^{+0,1} = drill dia	d = shank dia	D	K	kg/1000	ORDER CODE	BOX Q
M4	UKO30	0,5-3,0	10,75	6,0	6,0	6,5	0,5	0,4	514 525	10000
M5	UKO30	0,5-3,0	12,0	7,0	7,0	7,5	0,5	0,5	515 500	5000
M6	UKO30	0,5-3,0	14,5	9,0	9,0	9,5	0,5	1,2	516 500	3000
M8	UKO30	0,5-3,0	16,0	11,0	11,0	11,5	0,5	1,8	518 450	2000

All dimensions in mm - Technical data subject to modification
Tolerances and characteristics see chapter 'Technical Information'



Specials: Customized Solutions



- **In-house R&D and technical support for specific applications**

In 2014 Dejong has 60 years of experience in developing and manufacturing TUBTARA® blind rivet nuts. TUBTARA® has become synonymous with high quality performance, innovation, in-house R&D and technical support. Always being one step ahead of industry demand.

Tubtara's manufactured to customers' specifications, are developed to suit the demands of almost every application. These customized solutions offer additional features to the standard TUBTARA® such as increased torque-to-turn, sealing, controlled deformation, integration into parent material, centering, pressure spread, compatibility with other fasteners or tools, special thread requirements etc. The Tubtara's designed for the latest aerospace programmes for instance are used in composite material and aluminium structures on wing parts and seats.

Besides blind rivet nuts, Dejong also concentrates on cold forming selected parts according to customers' drawings for very specific applications.

For a detailed summary, visit <http://www.dejong.com/eng/tubtara/specials.htm>

To download our specials brochures, visit <http://www.dejong.com/eng/tubtara/catalogue.htm> and click on 'Brochure Special Tubtara Blind Rivet Nuts'





New knurled TUBTARA®

Nominal, knurled shank
 Flat or low profile head
 Open or closed end
 Steel, stainless steel 304 & 316

UPO & UKO KN

improved nominal knurls

TUBTARA® with improved knurl design and nominal diameter

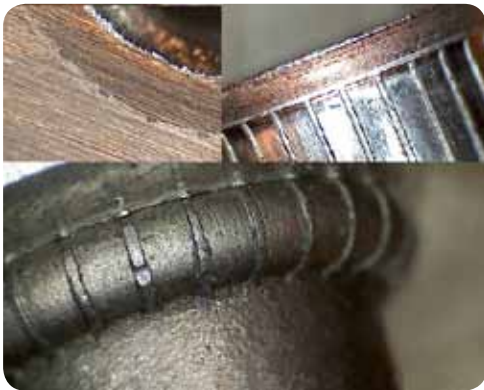

Comparison of torque-to-turn reference values* with Steel M6 UKO 30, low profile head and smooth shank:

Steel M6 UKO 30 KN	low profile head, improved knurl	+ 15 %
Steel M6 UPO 30	flat head, smooth shank	+ 30 %
Steel M6 UPO 30 KN	flat head, improved knurl	+ 45%
Steel M6 ATO 30	anti-turn head, round shank	+ 100%
Steel M6 HUPO 30	flat head, hexagonal shank	+ >300%

* All Tubtaras set in a 1,5 mm thick steel HRB 55 plate
 Real values depending on setting conditions

● Benefits

Ensuring increased torque-to-turn resistance, resulting in up to **15% higher Nm** values compared to smooth shank parts (values depending on material choice & geometry)

● Design

- KN knurls are optimal in size and number to intrude in soft (some aluminium grades) and even in hard (steel and stainless steel) base material
- contrary to the splined RS, the KN Tubtara has a nominal shank diameter
- the UKO KN version makes flush installation possible

● Samples

For detailed product offer: see [pg 14](#), [pg 15](#), [pg 40](#) and [pg 41](#)

Samples of stainless M5 UFO35 KN available on request (knurls on shank and under the head)





Stainless Steel A5 & A6

Standard shank versions
Standard head types
Open or closed end
1st and 2nd grips

superior corrosion protection

Cold formed TUBTARA® in high alloy austenitic stainless steel A5 and A6



● Material

Stainless steel A5 : 316 Ti – WNr 1.4571
Stainless steel A6 : 904L – WNr 1.4539

● Applications

- extremely demanding, chloride bearing applications where even A4 fasteners in stainless 316 offer insufficient corrosion protection
- A6 grade is also armoured against strong acid bearing environments
- civil engineering, tunnel infrastructures, ceiling panels in swimming pools etc.

● Important advantages

- improved corrosion protection, mainly thanks to considerable nickel and molybdenum content
- A6 guarantees increased protection against pitting and crevice corrosion, reaching a PRE (pitting resistance equivalent) value of 35 (compared to PRE 25 for stainless 316)

● Samples

Following samples available from stock: stainless A6 M6 UPO 30 – stainless A5 M8 UPO30 / M8 UPO 65 / M8 UFO 65 / M8 UKO 30 / M8 HUKO 30

Development of other dimensions in progress and upon request





Stainless watertight HX TUBTARA®

Semi-hexagonal shank
 Flat head with underhead seal
 Closed end
 Stainless steel 304 & 316

HX

watertight
 10 bar (IP68)

Stainless watertight HX TUBTARA® succesful up to pressure of 10 bar

- **Special HX head type**

The watertight HX head ensures metal-to-metal contact after setting, therefore assuring spin out resistance. The concept guarantees a well functioning seal away from the possible burrs at the drilled hole in the plate (see photo 3). The underhead seal provides very good protection against ingress of fluids, moisture, oil or dirt even under high pressures up to 10 bar (IP 68).

Standard o’ring seal material is NBR ([see pg 74](#)). Other materials are available on request.



- **Applications**

The HX TUBTARA® can be used in a wide variety of markets and applications.

- **Samples**

For detailed product offer: see [pg 20](#) and [pg 32](#).

- **HX in steel**

The steel version of the watertight HX is a standard part available in Zinktop (Cr^{VI}-free) (see page [pg 47](#)).





bigHead TUBTARA®

Extra large head
Standard TUBTARA®
Steel, stainless steel A2 & A4

for composite materials

TUBTARA® with extra large head for mechanical joining of composites or strong anchor applications



● Design

A disc or oversized washer is welded onto a standard Tubtara blind rivet nut's head. Both the rivet nut and the disc can feature additional characteristics resulting in a wide product versatility. A customized design could incorporate additional shank features (knurl, hex), disc forms (square, cylindrical) or characteristics like a keyed head or underhead cross.

● Advantages for composite applications

- customized mechanical fastening solutions
- the oversized head provides a large bearing area
- the bigHead is ensuring a greater load distribution into the substrate, resulting in higher pull-out values
- with a perforated disc design, the Tubtara can lock securely into position, embedded or not
- installed quickly and tightly, despite burrs or uneven surfaced substrates
- is hole size tolerant
- allows easy inspection possibility
- requires minimal surface preparation and can be disassembled after installation

The collaboration between bigHead Bonding Fasteners Ltd. and Dejong results from a customer specific application in the marine industry.





Anti-turn TUBTARA®

Round shank
 Anti-turn head
 Open / closed end
 Steel, stainless, aluminium

High torque values
 Easy to prepare
 Easy to install

**repair solution:
 extra high
 torque-to-turn values**

Torque-to-turn value at least twice as high as that of the equivalent round blind rivet nut

● Applications

All applications where hexagonal holes are not allowed or difficult to make

● Important advantages

- very effective on slippery surfaces
- no damage of the surface (↔ splined blind rivet nuts)
- very effective in hard material (↔ splined blind rivet nuts)
- use of standard round holes, so no risk of cracks on the corners (↔ hexagonal blind rivet nuts)
- easy to install with a standard setting tool
- no problem to set automatically
- possible to combine different material of nut and sheet (↔ welding nuts)
- technical details: see [pg 13](#) and [pg 39](#)

● Samples

Samples in steel M6-M10 and stainless M8-M10 available on request.

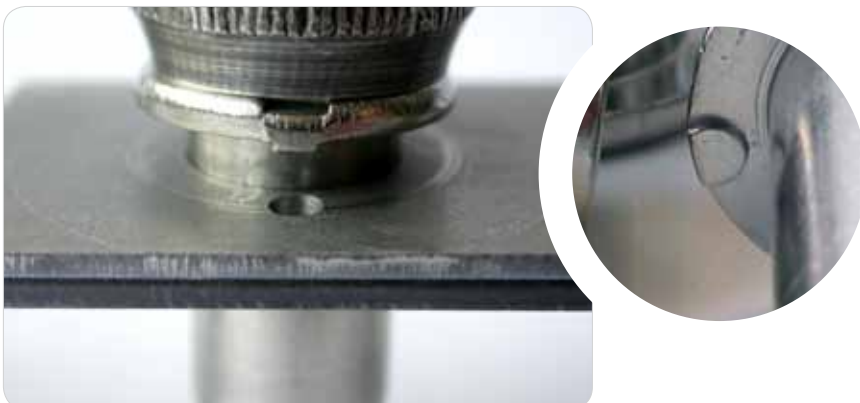

Setting equipment

- Hand tools to set blind rivet nuts



DFS 307 T

Compact & practical hand tool for light duty assembly.

Capacity:

Alu: M3 - M6

Steel: M3 - M5



DFS 311 T

Strong and reliable hand tool for heavy duty assembly in the field.

Capacity:

Steel & Alu: M6 - M12

Stainless steel: M6 - M10



NM 1

Small hand tool for prototype work and repairs.

Capacity:

Steel & Alu: M4 - M12

Stainless steel: M4 - M6

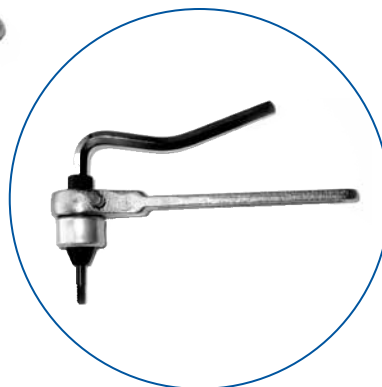



DFS 309 T

Heavy duty hand tool for field and low volume production use.
Push and pull mechanism.

Capacity:
All materials: M4 - M10

● **Spare parts available from stock**

- All parts for the current NM1 and DFS hand tools
- Add-on hex tooling to convert round holes into hexagon – can be used on standard setting equipment in the market

5059-9211	anvil M4 + lock nut
5059-9221	anvil M5 + lock nut
5059-9231	anvil M6 + lock nut
5059-9241	anvil M8 + lock nut
5059-9251	anvil M10 + lock nut
5059-9102	punch guide M4-M8

5059-9571	punch M4
5059-99641	punch M5
5059-99741	punch M6
5059-99821	punch M8
5059-9881	punch M10
5059-9111	punch guide M10

- Most spare parts for the following discontinued hand and pneumatic tools (until depletion of stock) :
NM1 Kombi - NG2 - NG7 - NM9 - NM6 - NG6

Setting method

Select one of the **TUBTARA®** blind rivet nuts out of our productrange and a setting tool adequate for the application. Take a test workpiece and drill an appropriate hole

Screw the **TUBTARA®** (A) on the mandrel (B) of the setting tool. For an open version the mandrel should protrude about 1 mm, for a closed one until you feel resistance.

Screw the anvil (C) against the head of the **TUBTARA®** and block it with the locking nut (D).

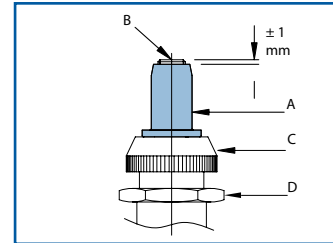

Introduce the **TUBTARA®** mounted on the setting tool, into the hole of the workpiece.

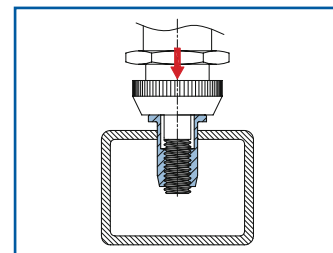

Set the **TUBTARA®**. The deformation chamber of the **TUBTARA®** is now forming the counterhead on the underside of the workpiece (bulb).

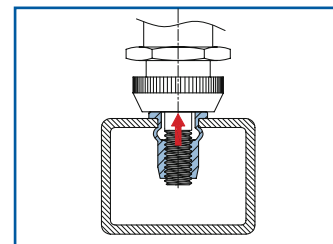

Unscrew the mandrel from the **TUBTARA®**.

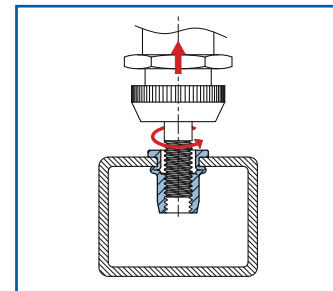

The **TUBTARA®** is set. Now you can easily insert your bolt or screw to assemble a component.

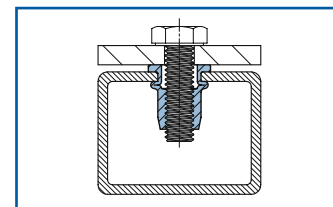

● Countersunk heads

When you use a **TUBTARA®** with a countersunk head, always countersink at 90° so that the head of the installed **TUBTARA®** protrudes about 0,1 mm above your workpiece. This ensures direct contact with the assembled component.

Don't you have the possibility to countersink?
Use a low profile head!

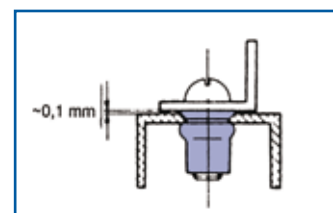

Materials

The **TUBTARA®** is available in steel, aluminium and stainless steel 304 & 316. For critical bearing environments, we can also offer superior cold formed stainless A5 or A6 quality on demand, next to several finishing options on stainless (like Cadmium, ZnNi, Seal Inox) or a passivation to cope with most environmental conditions.

Available from stock:

Material			W Nr
Aluminium	AlMg2,5	5052	3.3523
Steel	C8C	QST 34-3	1.0213
Stainless steel A2	304Cu		1.4567
Stainless steel A4	316Cu		1.4578

Available on request :

Material		W Nr
Stainless steel A5	316Ti	1.4571
Stainless steel A6	904L	1.4539

Material specifications are always subject to modifications.

● How to choose the right material ?

A proper choice of the right material and coating of the **TUBTARA®** is very important to obtain optimal functionality during the whole life cycle, especially when environmental conditions are unknown or critical. Influences can be chemical (in water dissolved elements), abrasive (sand), heat, friction, contact with other metals, corrosive environments etc.



● **Requirements & solutions :**

	Aluminium	Steel with appropriate coating	Stainless A2	Stainless A4	Stainless A5	Stainless A6
colour distinction		xxx				
visual identification		xxx				
weight-saving	xxx		x	x	x	x
durable	x	x → xxx	xx	xxx	xxx	xxx
easily recycable	xxx	xxx	xxx	xxx	xxx	xxx
electrical conductivity	xxx	xx	xx	xx	xx	xx
high/low temperature properties	x	xx	xx	xxx	xxx	xxx
non-magnetic	xxx		x	x	x	x
increased corrosion resistance	xx	o	xxx	xxx	xxx	xxx
resistant to atmospheric exposure	xx	o	xxx	xxx	xxx	xxx
resistant to chloride atmospheres		o		xxx	xxx	xxx
resistant to polluted environments		o		xxx	xxx	xxx
resistant to harsh environments		o			xxx	xxx
resistant to process fluids		o			xxx	xxx
top coating possible		xxx				
passivation possible			x	x	x	x

Legend	
o	possible influence
x	small influence
xx	larger influence
xxx	largest influence

● **Galvanic couples**

A suited material choice is not always easy and all conditions should be taken into account. The table below shows some connection guidelines for corrosion:

		Blind rivet nut material		
		zinc plated steel	aluminium	stainless steel 304 & 316
base metal wherein Tubtara is set	aluminium			
	zinc plated steel			
	brass, copper	T T®	T T®	
	stainless steel 4xx	T T®	T T®	
	stainless steel 304 & 316	T T®	T T®	

Legend	
	base metal and TUBTARA® ok
	base metal corrodes where in contact with TUBTARA®
T T®	base metal ok but TUBTARA® will corrode
	corrosion base metal heavily increased by TUBTARA®

We strongly advise to do some tests in the specific application environment on beforehand. Samples are available on request.

Coatings

A suitable coating choice can offer additional characteristics to your TUBTARA®.

● Coatings on steel available from stock :

Zinktop

High-quality Cr⁶⁺ & Ni free plating
 Conforms with ROHS 2, Reach, ELV directives
 96 h white rust - 480 h red rust
 10µ ±2µ

Zinc plated, yellow passivated (phase out 2016)

96 h white rust - 240 h red rust
 10µ ±2µ

● Survey available coating offer :

Next to the above-mentioned proven coatings, also other finishes are available on demand :



photo	coating description	standard / on request	salt spray test (h) ISO 9227		colour / aspect	corrosion protection	RoHS / Reach compliant	remarks
			white rust	red rust				
1	Zinc blue/white Cr ³⁺	REQ	24	72	blue/white	*	<input checked="" type="checkbox"/>	Cr ⁶⁺ free
2	Zinc black Cr ³⁺	REQ	48	96	black	*	<input checked="" type="checkbox"/>	Cr ⁶⁺ free
3/4	Zinc yellow Cr ⁶⁺	ST	96	240	yellow	***	<input checked="" type="checkbox"/>	phase out 2016
5	Zinktop	ST	96	480	light grey	****	<input checked="" type="checkbox"/>	Cr ⁶⁺ and Ni free
6	Zinktop Cobalt free	REQ	96	480	light grey	****	<input checked="" type="checkbox"/>	Cr ⁶⁺ , Ni and Co free
7	Ultra 1000	REQ	240	1000	matt grey	*****	<input checked="" type="checkbox"/>	Cr ⁶⁺ and Ni free
8	ZnNi (Zinc Nickel)	REQ	quality according to customer's specs					
9	Vibraseal®	REQ	x	x	red, green			seals + anti-vibration
10	Gleitmo®	REQ	x	x	-			friction reduction
-	Seal inox®	REQ	x	x	-			avoids galling stainless steel

The Ultra 1000 is more than doubling the resistance to red rust in the salt spray test compared to the standard Zinktop. The offer of blue and black trivalent coatings, as well as the Cobalt free Zinktop, are developed to tackle imminent Reach regulations and can be delivered on demand.

● Why use a coating ?

Requirements & solutions :

	Zinktop on steel	Coloured plating on steel	Passivation on stainless steel	Gleitmo®	Vibraseal®	Seal Inox™	Molykote®
appropriate visual aspects		+					
colour distinction		+			o	o	
to avoid galling				+		+	+
reduction of friction				+		+	+
increase of friction				-		-	-
to avoid galvanic couple	o	o	+		+	+	
electrical conductivity	+				-	-	-
anti-vibration function					+		
increased corrosion resistance	+		+			+	
seal function					+	+	
UV illumination				+			

Legend	
-	negative influence
o	possible influence
+	positive influence

We strongly advise to do some tests in the specific application environment on beforehand. Samples are available on request.



Technical Data

● General tolerances

	Head form	Dimensions in mm	Dimensions in inches
D (head diameter)	Flat head Countersunk head Low profile head	$\pm 0,35$ 0 -0,5 -0,15 +0,3	$\pm .014$ 0 -.020 -.006 +.012
K (head thickness)	Flat head Countersunk head Low profile head	$\pm 0,15$ 0 +0,3 -0,05 +0,3	$\pm .006$ 0 +.012 -.002 +.012
L (length)	General Stainless M10 shank 13 mm	$\pm 0,35$ $\pm 0,5$	$\pm .014$ $\pm .020$
Metric thread= 6H			
Shank size	General (incl. KN) Splined shank (RS) M10 shank 12,4 mm	-0,02 -0,15 $\pm 0,08$ $\pm 0,08$	-.001 -.006 $\pm .003$ $\pm .003$

Example:

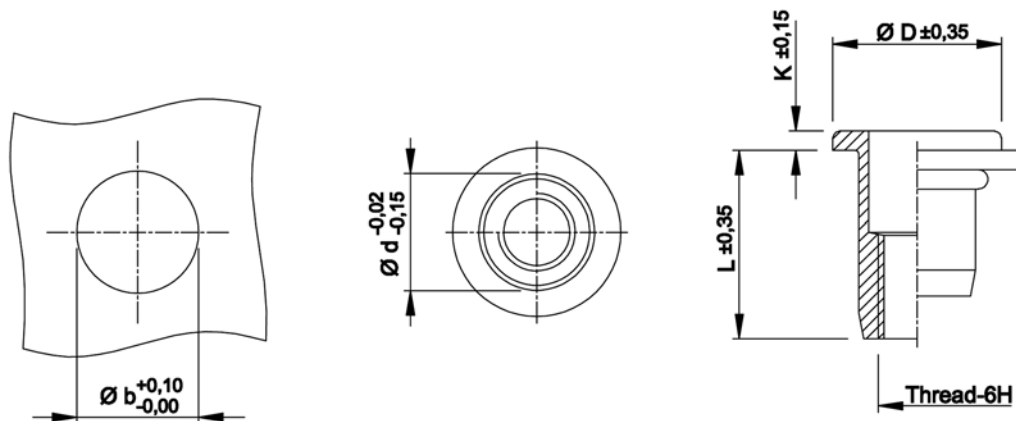

● Recommended tightening torque values (Nm)

Max. recommended torque to avoid damaging the threaded connection and ensure optimal screw - nut assembly:

	M3	M4	M5	M6	M8	M10	M12
Aluminium	2,0	2,2	4,5	9,5	17,0	30,0	
Steel	2,5	3,0	5,9	11,0	25,0	49,0	80,0
Stainless Steel	2,5	3,0	5,9	11,0	25,0	49,0	

Recommendations for 8.8 bolts in steel and class A2-70 bolts in stainless steel.

● Mechanical properties

The tables below show some indicative standard values for Tubtara's with round shank and flat head in first grip:

Mechanical reference values

product	material	pull-out	max. torque	torque-to-turn	shear test
		kN	Nm	Nm	kN
	Steel C8C	> 5,75	> 2,0	1,8	1,9
M3 UPO 20	Alu 5052	> 3,10	1,9	0,8	0,6
	SS 304Cu	-	-	-	-
	Steel C8C	> 10,75	> 7,5	2,7	2,6
M4 UPO 30	Alu 5052	> 4,50	4,9	1,4	1,1
	SS 304Cu	> 11,00	7,1	2,6	3,5
	Steel C8C	> 12,00	> 10	4,7	3,5
M5 UPO 30	Alu 5052	> 5,20	4,9	1,5	1,6
	SS 304Cu	> 14,50	> 16,0	3,0	4,8
	Steel C8C	> 21,00	> 19	7,0	5,0
M6 UPO 30	Alu 5052	> 10,50	16,0	3,2	2,4
	SS 304Cu	> 27,00	> 22,0	6,8	7,3
	Steel C8C	> 33,00	> 50	13,0	6,0
M8 UPO 30	Alu 5052	> 15,00	33,0	5,3	2,9
	SS 304Cu	> 40,00	> 70,0	9,0	9,0
	Steel C8C	> 40,00	> 70	15,0	8,0
M10 UPO 35	Alu 5052	> 20,00	39,5	7,0	3,7
	SS 304Cu	> 43,00	> 70,0	8,0	8,5
	Steel C8C	> 40,00	> 70	15,0	8,0
M10 SPO 35	Alu 5052	-	-	-	-
	SS 304Cu	> 43,00	> 70	13,0	8,4
	Steel C8C	> 63,00	> 150,0	32,0	11,5
M12 UPO 40	Alu 5052	-	-	-	-
	SS 304Cu	-	-	-	-

- Bolts class 8.8 were used
- > : value will be higher, but test could not be completed due to breakage of bolt or min. value is used as reference
- Steel plate (HRB 55) was used to set the **TUBTARA®** (approximately middle of grip range)

Geometrical reference values

product	material	setting force	stroke	size bulb forming	length under plate
		kN	mm	mm	mm
	Steel C8C	4	2,6	6,55 à 6,65	5,90 à 6,10
M3 UPO 20	Alu 5052	2,3	1,9	6,00 à 6,10	6,40 à 6,60
	SS 304Cu	-	-	-	-
	Steel C8C	4,5	2,8	7,80 à 7,90	6,65 à 6,80
M4 UPO 30	Alu 5052	2,2	2,7	7,70 à 7,80	6,80 à 6,95
	SS 304Cu	6	2,4	7,25 à 7,40	7,60 à 7,80
	Steel C8C	6,5	3,8	9,35 à 9,45	7,25 à 7,40
M5 UPO 30	Alu 5052	3,35	3,6	9,30 à 9,40	7,25 à 7,40
	SS 304Cu	8	3,5	8,90 à 9,15	7,25 à 7,50
	Steel C8C	9,5	4	11,60 à 11,75	9,25 à 9,55
M6 UPO 30	Alu 5052	4,9	3,3	11,15 à 11,25	10,00 à 10,20
	SS 304Cu	13	4	11,30 à 11,55	9,60 à 10,00
	Steel C8C	12	4	13,60 à 13,80	10,90 à 11,15
M8 UPO 30	Alu 5052	5,5	3,8	13,60 à 13,75	11,10 à 11,30
	SS 304Cu	15,4	4,2	13,55 à 13,65	11,30 à 11,55
	Steel C8C	14,5	4,4	15,65 à 15,75	14,35 à 14,50
M10 UPO 35	Alu 5052	8	4,7	15,60 à 15,90	14,10 à 14,40
	SS 304Cu	15,5	4	14,80 à 15,00	13,60 à 13,95
	Steel C8C	15,5	4,5	16,10 à 16,25	15,50 à 15,70
M10 SPO 35	Alu 5052	-	-	-	-
	SS 304Cu	23,5	4,6	15,85 à 16,10	16,60 à 16,85
	Steel C8C	20,5	6,5	20,80 à 20,95	17,50 à 18,00
M12 UPO 40	Alu 5052	-	-	-	-
	SS 304Cu	-	-	-	-

Variations due to setting and environmental conditions can be expected in practice. The values can be used as reference and optimized by using additional features.

The following values can be used as a guidance for other versions :

TYPE	Grip	ALUMINIUM			STEEL			STAINLESS STEEL 304 + 316		
		SETTING FORCE	STROKE	PULL-OUT	SETTING FORCE	STROKE	PULL-OUT	SETTING FORCE	STROKE	PULL-OUT
		N	mm	N	N	mm	N	N	mm	N
M3 UPO 20	1	2000	2	3750	4000	2,5	> 5000			
	2	2600	1,5	3280	4750	2	> 5000			
M3 UPO 30	2	1850	1,5	3900	3700	2,5	> 5000			
	3	2050	1	3968	4750	2	> 5000			
M4 UPO 20	1							4900	2	> 9000
	2							5500	1,5	> 9000
M4 UPO 30	1	2100	3	5170	4300	2,5	> 8000			
	3	2430	1	4330	5650	1,5	> 8000			
M4 UPO 35	2							5500	2,6	> 9000
	3,5							6000	1,7	> 9000
M4 UPO 45	3	2050	2,75	4838	4200	2,5	> 8000			
	4,5	2875	1,5	4421	5000	1,5	> 8000			
M5 UPO 30	1	3050	3,5	5500	6150	3,5	12240	7500	3	> 15000
	3	3650	2	5000	7200	2,5	9600	8500	1,7	> 15000
M5 UPO 50	3							7500	4	> 15000
	5							8500	2	> 15000
M5 UPO 55	3	3000	3,5	6450	5750	4	11800			
	5,5	4300	1,5	5525	9650	2	10300			
M6 UPO 30	1	4500	3	11000	9400	4	21200	11850	4	> 24000
	3	5750	2	10000	12000	3	18500	14460	3	> 24000
M6 UPO 50	3							13500	4,5	> 24000
	5							15000	2,75	> 24000
M6 UPO 55	3	4500	3,5	11000	9000	3,5	22700			
	5,5	6100	1,75	10000	11000	2	19700			
M6 UPO 80	5,5	4950	4,7	9160	8700	4	19900			
	8	5400	2	8200	11750	2,5	17200			
M8 UPO 30	1	5000	3	14900	11500	4	30400	14500	4,2	> 41000
	3	6600	2	14000	13750	2,5	26100	18000	2,8	> 41000
M8 UPO 55	3	5400	4	15500	11500	4	32500	14500	5,5	> 41000
	5,5	7400	2	11200	15500	2,5	31900	18500	3	> 41000
M8 UPO 80	5,5	5900	4	16100	10700	4	32400			
	8	7850	2	13600	14700	2,5	26500			

TYPE	Grip	ALUMINIUM			STEEL			STAINLESS STEEL 304 + 316		
		SETTING FORCE	STROKE	PULL-OUT	SETTING FORCE	STROKE	PULL-OUT	SETTING FORCE	STROKE	PULL-OUT
		N	mm	N	N	mm	N	N	mm	N
M10 UPO 30	1							14500	3,5	> 45000
	3							18500	2,5	> 45000
M10 UPO 35	1	6750	4	22100	13600	4,5	39600			
	3,5	9000	2,5	17700	17000	2,5	32400			
M10 UPO 50	3							14500	3,5	> 39500
	5							18500	2,5	> 37000
M10 UPO 60	3,5	9000	5	25250	14900	4	42300			
	6	13000	3	23000	17900	2,5	31700			
M10 SPO 35	1				13500	4,5	40500	19500	4,5	> 45000
	3,5				16100	2,5	36100	26500	3,5	> 45000
M10 SPO 60	3,5				15900	5,5	48000			
	6				20400	3	37500			
M12 UPO 40	1				19500	5,5	> 50000			
	4				25000	4	> 50000			
M12 UPO 70	4				19500	5,5	> 50000			
	7				25000	4	> 50000			

Setting Force or Upset Load: Force (in Newton) necessary to deform the **TUBTARA®** referred to in an adequate way.

Upset Stroke: Stroke (in mm) that should be set on the setting tool to give the **TUBTARA®** referred to, the adequate deformation.

Pull-out or Ultimate Thread Strength: Surpassing this ultimate force (in Newton), the thread of the set **TUBTARA®** will be pulled out.

The mentioned values are average reference values only.

We strongly advise the customer to do his own tests in the proper material thickness and specific application.

● **Testing methods**

Next to the standard inspections during the production process the following tests can be done on customer's request :

- Pull-out test
- Maximum torque
- Push-out test
- Shear test
- Torque-to-turn
- Length under plate
- Size bulb forming

● **HX TUBTARA® with seal under the head**

Information about NBR O-Ring & compatibility with other products					
Shore Hardness	70 - 95	Aromatic Hydrocarbons	x	Lye	x
Hydraulic fluids	xxxx	Aliphatic Hydrocarbons	xxx	Chlorinated Hydrocarbons	x
Fuel Oils	xx	Water under 80°C	xxx	Ozone & Sunlight	x
Organic Oils	xxxx	Water over 80°C	x	Temperature range °C	-35 +120
Brake Fluid	-	Alcohols	xx	Electr. properties	-
Silicone & Grease	xx	Ketone	-	Compression sets	xxx
Gasoline	xxx	Acid (concentrated)	-	Flame resistance	No
Aromatic fluids up to 50 %	xx	Acid (diluted)	x		
Kerosene	xxx				

Key: xxxx very good --> x satisfactory - not suitable.

Storage: protect against UV-light; store in a dry and dark place (all boxes are marked)

Seals in other materials like Viton on request.

(for productinfo [see pg 20](#), [pg 32](#), [pg 47](#) & [pg 58](#))

● **Conversion table**

Multiply	by	To get
millimeter (mm)	.03937	inch (in)
inch (in)	25,4	millimeter (mm)
kilogram (kg)	2,2046	pound (lb)
pound (lb)	0,4536	kilogram (kg)
Newton (N)	0,2248	pound-force (lbf)
Newton metre (Nm)	8,8507	pound-inch (Lb-In)

3D drawings

<http://www.dejond.com/eng/tubtara/3Ddrawings.htm>

- 3D and 2D drawings for all **TUBTARA®** stainless steel blind rivet nuts
- Downloadable in installed or uninstalled condition
- User input option for exact grip
- Numerous formats (DWG, STP, SolidWorks, Autodesk, Spaceclaim, AutoCAD etc.)
- Possibility to insert the **TUBTARA®** CAD drawing directly into the product design

External website hosted by "Traceparts online":

www.tracepartsonline.net/ws/dejond



Quality

Reach / RoHS / Conflict Minerals: see statement on our [website](#) or contact our sales department for all information.

EN 9100:2009 - AS 9100C - JISQ 9100:2009 certified



DEJOND IS NOT LIABLE FOR ANY PRINTING ERRORS AND RESERVES THE RIGHT TO CHANGE ALL DATA CONTAINED IN THIS CATALOGUE WITHOUT PRIOR NOTICE

Information cannot be copied or reproduced without permission of Dejond N.V.

General conditions available on our website www.dejond.com

Any dispute will fall within the exclusive jurisdiction of the courts of Antwerp

TUBTARA® - Your reliable connection



DEJOND
COLD FORMING

Terbekehofdreef 55-59

B - 2610 Wilrijk (Antwerp)

Belgium

Tel: +32 (0)3 820 34 36

Fax: +32 (0)3 820 35 36

E - mail: coldform@be.dejond.com

www.dejond.com