

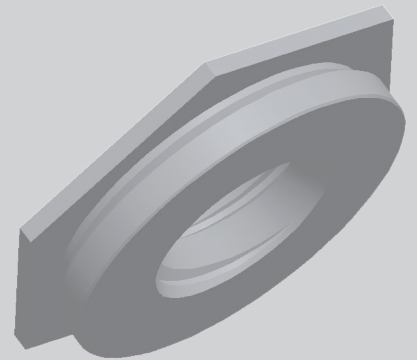

**captive**<sup>®</sup>  
fastener corporation

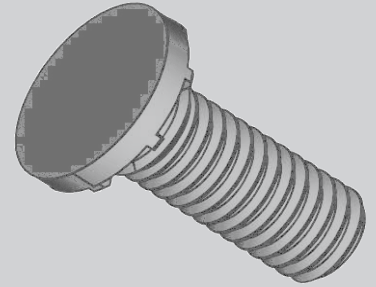

*SELF-CLINCHING FASTENERS*

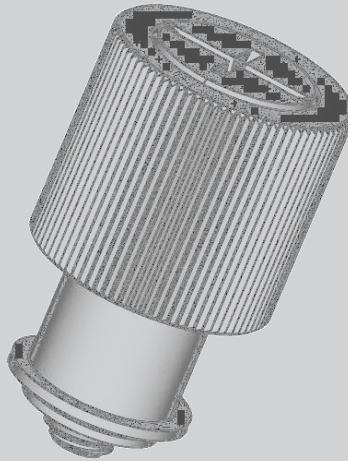
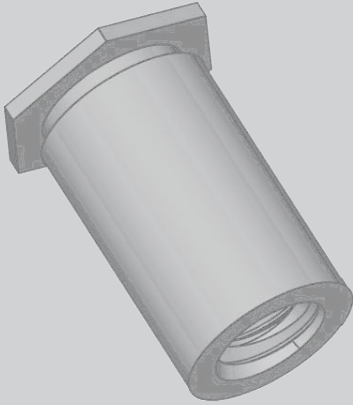
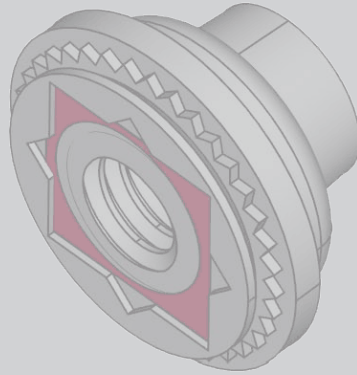
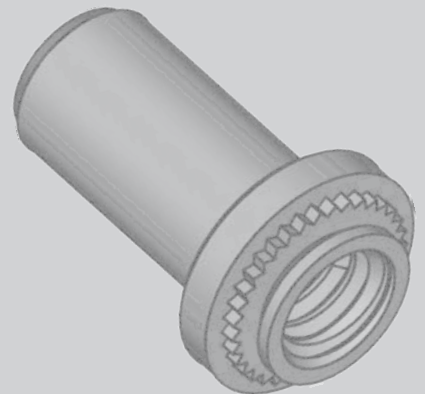
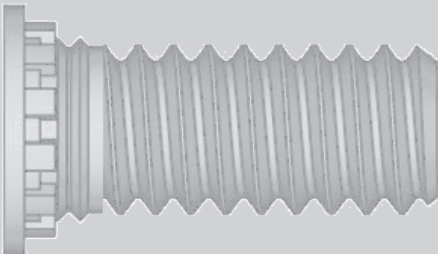



# Self-Clinching Fasteners

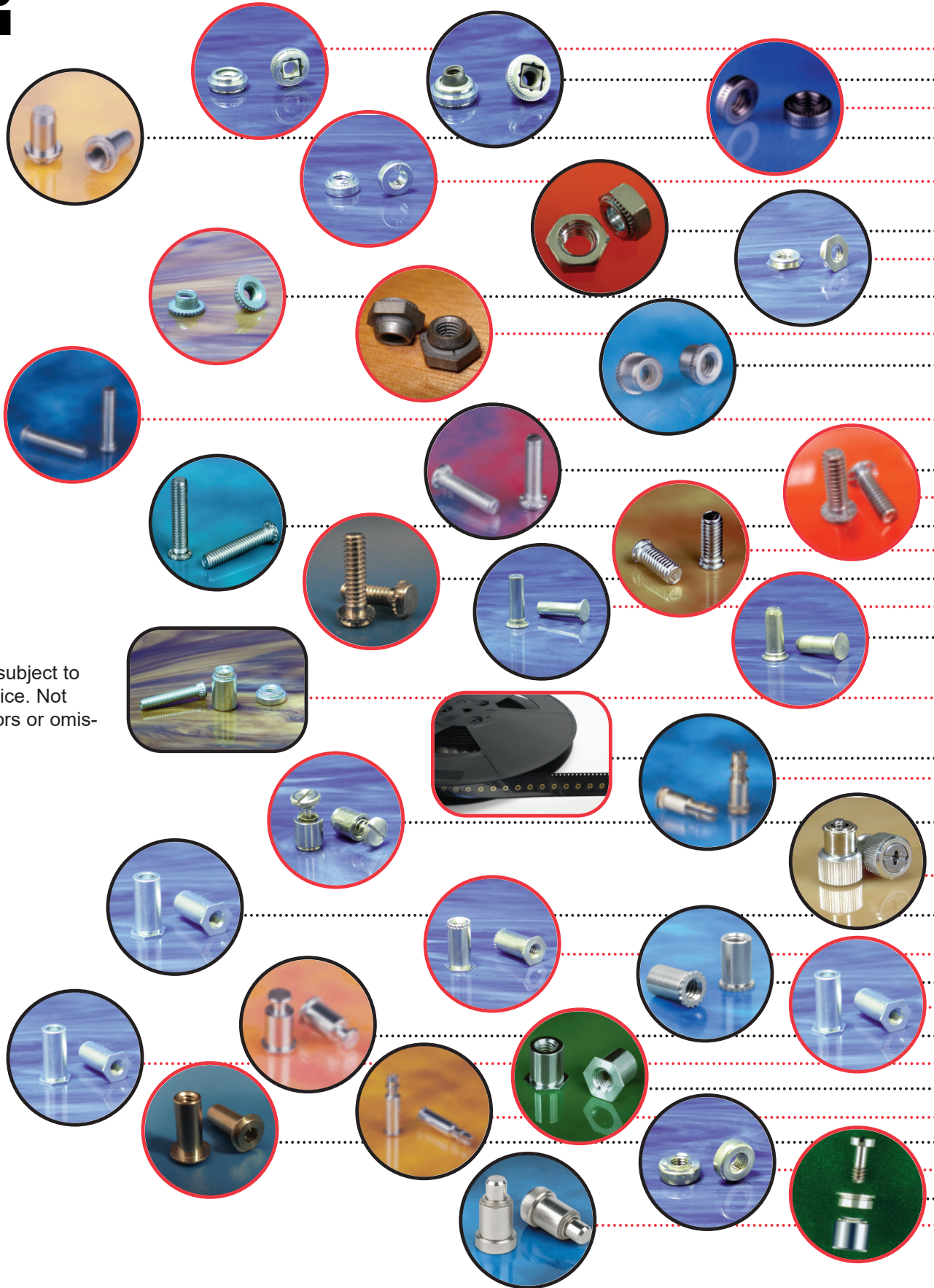

Specifications are subject to change without notice. Not responsible for errors or omissions.

# Table of Contents

CAPTIVE FASTENER® SERIES	DESCRIPTION	PAGE
	About the Company / Product Description	4-8
CFAS, CFAC	Self-Clinching Floating Nuts	9-10
CFFS, CFFC	Self-Clinching Floating Locking Nuts	11-12
CFSP	Self-Clinching Nuts for Stainless Steel	13-14
CFB, CFBS	Self-Clinching Blind Press Nuts	15-16
C / CS	Self-Clinching Nuts	17-21
CFH, CFHN	Self-Clinching Steel Heavy Duty Nuts	22
CA	Self-Clinching Aluminum Nuts	23
CKN	Self-Clinching KAL Hex Nuts	24
CFL	Self-Clinching Flush Nuts	25-26
CFE, CFEO CFEX, CFEOX	Self-Clinching Miniature Self-Locking Fasteners	27-28
CRT	Self-Clinching Self-Locking Nuts	29-30
CPL, CPLC	Self-Clinching Top Collar Lock Nuts	31-32
CH, CHS, CHA,	Self-Clinching Studs, Flush Head	33-35
CHTS	Self-Clinching Studs, For Stainless Steel	36-38
CH2S	Self-Clinching Studs For Stainless Steel (Superior Corrosion Resistance)	39-40
HCH, HCHS, HCHB	Self-Clinching Studs, High Torque	41-42
HCW	Self-Clinching Studs, Wide Head	43-44
TCH, TCHS	Self-Clinching Studs, Thin Sheet	45-46
CHE, CHES	Self-Clinching Close-to-Edge Studs	47-49
CFA-1, CFA-2 / CFC-1, CFC-2	Self-Clinching Concealed Head Studs	50-52
CH, CHN, CHS, CHA	Self-Clinching Pins	53-54
CGS	Self-Clinching Tapered Guide Pins	55
CKF2, CKFS2	Broaching Type Nuts	56-57
CKFE, CKFSE	Broaching Type Standoffs	58
CKFH	Broaching Type Studs	59
CKFB3	Broaching Type Flare Mounted Standoffs	60
CRM	Reel Mounted Spacers and Nuts	61
CFKSSB	Broaching Type Spring-Top Standoffs for PC Boards	62-63
CPFK	Broaching Type Panel Fasteners	64
LPH-0, 1, 2	Self-Clinching Low-Profile Panel Fasteners	65-66
CPFC2	Self-Clinching Panel Fastener Assemblies	67-68
PSK / PSS	Self-Clinching Collar Based Panel Fasteners	69-70
CFSO, CFSOS, CFSOA CFBSO, CFBSOS, CFBSOA	Self-Clinching Standoffs	71-77
CFSOSG, CFSOAG	Self-Clinching Grounding Standoffs	78
CF40, CF40S	Self-Clinching Miniature Standoffs	79-80
CF4-S0, CF4-BS0	Self-Clinching 400 Series Stainless Steel Standoffs	81-83
CFSKC	Self-Clinching Slide-Top Standoffs	84-85
CFSO, CFSOS, CFSOA	Self-Clinching Unthreaded Thru-Hole Standoffs	86-87
CFT, CFTS, CFTA	Self-Clinching Thin Head Standoffs	88-90
CFSSA, CFSSS, CFSSC	Self-Clinching Spring-Top Standoffs	91-92
CFHS-1, CFHS-2	Self-Clinching Concealed Head Standoffs	93-95
CFWN, CFWNS	Weld Nuts	96-97
CFS2, CFR2, CFN2	Panel Screw Components	98-101
CPN, CPR	Self-Clinching Spring-Loaded Plungers	102-103

“PEM” is a registered trademark of PennEngineering®



# About the Company

Since 1974, **Captive Fastener Corporation** has been solely dedicated to manufacturing the finest quality self-clinching fasteners for a variety of industrial and electronics equipment produced by major OEM's. Typical applications include the manufacture of computers, business machines, communication equipment, industrial controls, vending machines, automotive and other precision fabricated metal products.

## Quality Manufacturing:



Captive has two facilities containing a total of over 100,000 square feet of manufacturing space. At these sites, **Captive** produces a wide range of self-clinching fasteners under a strict quality control program, which ensures compliance to product specifications and performance criteria. Final inspection includes laser or vision system



sorting to assure all critical dimensions are met. Also, **Captive's** Engineering Department is available to evaluate new applications and develop special designs tailored to meet your specific needs.

## Product Conformance:

ROHS (Restricted use of Hazardous Materials) - **Captive** is compliant with the European Union RoHS Directive, as it applies to certain restricted hazardous substances in the fasteners we currently manufacture.

DFARS (Defense Federal Acquisition Regulation Supplement) - Upon Request when ordering, **Captive** can provide product that is manufactured from materials that are produced in the United States or a qualified country.

REACH (Registration, Evaluation, Authorization and Restriction of Chemicals) - All current **Captive** products are exempt from REACH since they do not have SVHC's (Substance of Very High Concern) exceeding the 0.1% by weight limit, set by the European Chemicals Agency (ECHA).

## Personal Service:

As **Captive Fastener** has steadily grown over the years, we have maintained a close-knit organization. Most important is our commitment to customer service, which is the key to our success. Care, special attention and on-time deliveries, supported by a network of sales representatives and distributors situated around the world, provide customers with the quality and response time required in today's business environment.

## Website:

Visit our website at [www.captive-fastener.com](http://www.captive-fastener.com), where you can view the latest product information, find a local distributor, request a quote and download 3D CAD drawings to include in your new design project.

**Approved supplier for major OEM's (partial listing)...**

ATT	IGT	ITT	Dell
Cisco	Motorola	BMW	Nokia
Daktronics	Harris	Xerox	Ericsson
Honeywell	GE	Hewlett Packard	Alcatel-Lucent
Philips	Raytheon	IBM	Marconi



# Product Description

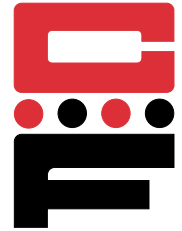

**Captive Fasteners** are available in three basic groups:

1. Self-clinching fasteners for ductile materials.
2. Broaching fasteners for non-ductile materials
3. Weld nuts for sheet metal.

## Advantages:

All **Captive** self-clinching fasteners install into a round hole which may be punched or drilled into ductile materials. All **Captive** broaching fasteners install into a round hole, which may be drilled into non-ductile materials. **Captive** weld nuts are designed for attachment to carbon steel and stainless steel sheet material. All three fastener types provide a permanently attached fastener which becomes an integral part of the panel or frame and eliminates the problems associated with loose hardware. **Captive** fasteners provide added value by speeding initial assembly as well as servicing in the field, keeping costs to a minimum.

## Installation Principles:

**Captive** self-clinching fasteners are pressed into holes in sheet metal by applying a steady squeezing force. This results in the cold-flow of sheet metal, which is displaced by the knurl, into the undercut area on the shank of the fastener. Once fully embedded, the knurled area prevents torque-out during tightening of mating part. **Captive** broaching fasteners are pressed into printed circuit boards and non-ductile materials and held permanently in place by an interference fit. Both self-clinching and broaching types withstand high push-out and torque-out forces. **Captive** weld nuts are self piloting into holes and are round, eliminating the need for indexing. Pilot shanks protect threads from weld spatter.

### Typical Self-Clinching Nut Installation

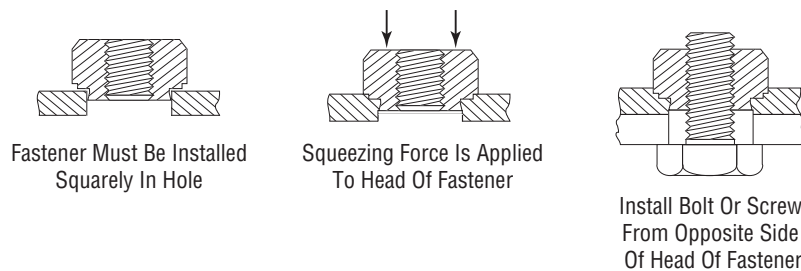

## Interchangability:

All **Captive** self-clinching fasteners conform to industry standards, which enables them to be fed through all standard automatic insertion equipment, and provide a substitute for form, fit and function.

## Typical applications for **Captive** self-clinching fasteners:

ATM's	CATV	Gaming Machines	Printers
Agriculture Equipment	Computers	Gas Pumps	Stereo Equipment
Air bags	Control Panels	Hospital Beds	Telecommunication
Alarm Systems	Copiers	Laser Equipment	Telephone Systems
Appliances	DVD Players	Medical Equipment	Televisions
Arcade Games	DVR's	Microwave Equipment	Test Equipment
Automotive	Fabricated Metal	Modems	Truck Roll-up Doors
Avionics	Facsimile	Office Furniture	Vending Equipment
Black Boxes	Food Processing	Power Supplies	





# Locking Patch

Offered by Captive Fastener

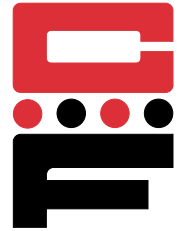

The ND Patch coating process produces a completely dry product that is fused to the fastener and is ready to use right out of the box. ND Patch performs immediately upon assembly with no curing time required.

## How ND Patch Works:

- When assembly with a mating part the resilient ND Patch is compressed. The compressed engineering plastic (typically a Nylon Patch) provides locking action in the thread instead of at the bearing surface due to its vibration dampening characteristics. In general, the resilience of ND Patch holds the fastener in place with our adhesives or thread distortion. Due to its resilience, Patch can be repeatedly adjusted and reused.
- ND Patch is normally positioned on to three threads back from the end of the fastener to assure ease of starting. The normal coating length of the Patch is four to six threads. Special Patch location and coating length can be specified for specific applications.

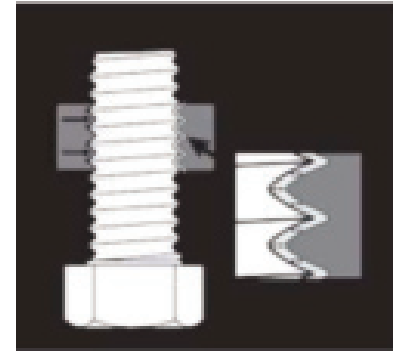

## Features:

**Saves Time:** Fasteners coated with ND Patch can be automatically fed through standard feeding devices.

**Retains Full Strength:** ND Patch process involves no drilling or milling, so there is no loss of the fastener's Strength or hardness and any troublesome burrs or chips.

**Saves Money:** Use of ND Patch eliminates the need for costly lock washers, cotter pins, or castellated nuts. You get a close fit without the cost involved in obtaining close tolerances. Moreover, ND Patch is less expensive than applying bottle thread locking compounds at the point of assembly.

**Resists Heat & Cold:** ND Patch meets and exceeds IFI Specifications 124 & 524 as well as Military specification MIL-DTL-18240F, Type P, for temperatures from -70°F (-56°C) to -250°F (121°C).

**Chemical Resistant:** ND Patch will not dry, Shrink, or lose resiliency when exposed to commercial solvents, alcohol, gasoline, oil, caustic soda, jet fuel, etc.

**Reusable:** Fasteners coated with ND Patch can be reused repeatedly with our damage to threads. ND Patch is particularly resistant to deformation, which makes it ideal for repeated use.

*Note: Minimum Order Quantities Apply.*

*ND Patch® is a registered trademark of ND Industries.*



# Thread Coating

Offered by Captive Fastener

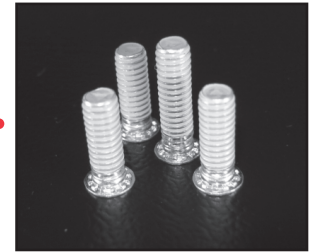

## ND LM-1293®

ND LM-1293 is an automotive approved process in which fasteners are accurately coated with one of a variety of thread masking and lubricating materials. The use of a Teflon® type material and a proprietary binder system in ND LM-1293 makes it the ideal coating for many applications.

### Description:

ND LM-1293 can be applied to male or female, ferrous or non-ferrous threaded fasteners in virtually any finish. It is a cross-linked coating providing excellent solvent resistance, high temperature resistance, e-coat resistance (as specified under GM6076-M), resistance to weld spatter, and improvement to torque-tension properties.

ND LM-1293 lubricates fastener threads to reduce driving friction, heat buildup, and thread galling in long rundowns while helping to ensure uniform clamp loading.

To meet your specific application needs, ND LM-1293 employs a wide range of polymers, including fluorinated ethylene polymer (Teflon®-type) material.

### Features:

**Reliable Masking:** ND LM-1293 prevents undesirable substances such as electrodeposits, undercoating, weld spatter and some other materials from adhering to fastener threads.

**Low Heat Process:** Unlike competitive processes which often subject parts to extremely high temperatures that may damage or discolor the fastener, ND's unique patented process employs minimal heat.

**Minimal Pre-cleaning Requirements:** Unlike competitive processes that require parts to be completely free of oil or other rust preventative coatings, only parts with excess oil or surface contaminants may require pre-cleaning for ND LM-1293 processing.

**Increases Productivity:** By providing additional lubricity, ND LM-1293 speeds assembly operations and increases productivity.

**Eliminates Capping and Plugging:** ND LM-1293 eliminates the need to cap male and plug female threads.

*Note: Minimum Order Quantities Apply.*

*ND LM-1293® is a registered trademark of ND Industries.  
Teflon® is a registered trademark of Dupont de Nemours & Co. Inc.*





# Self-Clinching Floating Nuts

## Series CFAS & CFAC

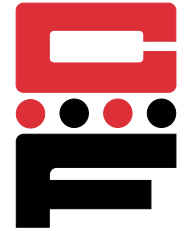

CFAS & CFAC floating clinch nuts provide a self-clinching fastener with a floating nut that compensates for mating misalignments to .030 inches (.8 mm).

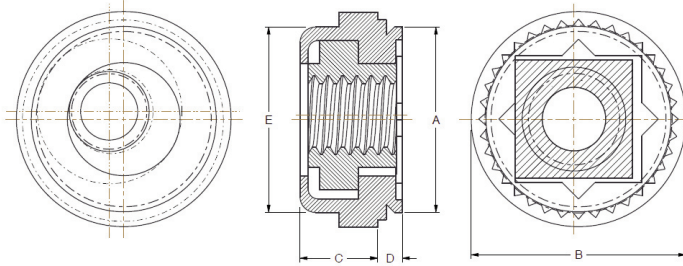

Series	Material	Finish
CFAS	Heat-treated Carbon Steel	Zinc* Clear
CFAC	300 Series Stainless Steel	Passivated ASTM A967

\*See Finish Spec. on Page 6.

Thread: Internal 2B, ANSI B1.1  
(6H, ANSI/ASME B1.13M).

Float: .015 in. (.4mm) minimum in all directions from center, .030 in. (.8mm) total.

STARBURST® design indicates genuine Captive self-clinching Floating Nut.

Use in: Materials with Rockwell Hardness of B-70 or less.

### Dimensions & Specifications

Thread Size	Part Number		D Max	Min.	+0.003 in. (.08mm) -0.000(.00)	A Max	E Max	B ±.015 in. (±.38mm)	C Max	Min.	
	Carbon Steel	Stainless Steel									
INCH (in.)	#4-40	CFAS440-1	CFAC440-1	.038	.038	.290	.289	.290	.36	.130	0.3
		CFAS440-2	CFAC440-2	.054	.054						
	#6-32	CFAS632-1	CFAC632-1	.038	.038	.328	.327	.335	.39	.130	0.32
		CFAS632-2	CFAC632-2	.054	.054						
	#8-32	CFAS832-1	CFAC832-1	.038	.038	.368	.367	.365	.44	.130	0.34
		CFAS832-2	CFAC832-2	.054	.054						
	#10-24	CFAS1024-1	CFAC1024-1	.038	.038	.406	.405	.405	.47	.170	0.36
		CFAS1024-2	CFAC1024-2	.054	.054						
#10-32	CFAS1032-1	CFAC1032-1	.038	.038	.406	.405	.405	.47	.170	0.36	
	CFAS1032-2	CFAC1032-2	.054	.054							
1/4-20	CFAS420-2	CFAC420-2	.054	.054	.515	.514	.510	.60	.210	0.42	
1/4-28	CFAS428-2	CFAC428-2	.054	.054							
METRIC (mm)	M3x0.5	CFASM3-1	CFACM3-1	.97	.97	7.37	7.36	7.37	9.14	3.31	7.62
		CFASM3-2	CFACM3-2	1.38	1.38						
	M4x0.7	CFASM4-1	CFACM4-1	.97	.97	9.35	9.33	9.28	11.18	3.31	8.64
		CFASM4-2	CFACM4-2	1.38	1.38						
	M5x0.8	CFASM5-1	CFACM5-1	.97	.97	10.31	10.29	10.29	11.94	4.32	9.14
		CFASM5-2	CFACM5-2	1.38	1.38						
M6x1.0	CFASM6-2	CFACM6-2	1.38	1.38	13.08	13.06	12.96	15.24	5.34	10.67	

†Not stocked, available on special order.

Continued on next page.



# Self-Clinching Floating Nuts

## Series CFAS & CFAC

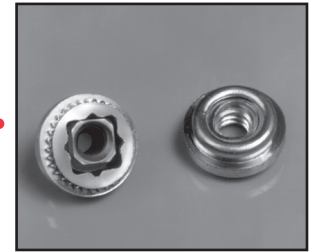

Continued from previous page

### Installation & Performance Data

Thread Size	Shank	Cold-rolled Steel			2024-T3 Aluminum			5052-H34 Aluminum			
		Installation Force (lbs.)	Pushout (lbs.)	Torque-out (in.-lbs.)	Installation Force (lbs.)	Pushout (lbs.)	Torque-out (in.-lbs.)	Installation Force (lbs.)	Pushout (lbs.)	Torque-out (in.-lbs.)	
INCH (in.)	#4-40	-1	3000	300	85	3000	220	65	1500	215	65
		-2	3000	300	150	3000	225	150	2000	225	80
	#6-32	-1	3000	300	150	3000	235	110	2000	240	140
		-2	3000	300	175	3000	275	150	2000	250	150
	#8-32	-1	3000	300	150	3000	240	110	2000	250	140
		-2	3000	400	200	3000	300	150	2000	265	150
	#10-24	-1	3500	400	150	3500	300	150	2000	300	150
		-2	3500	450	200	3500	300	200	2000	350	175
	#10-32	-1	3500	400	150	3500	300	150	2000	300	150
		-2	3500	450	200	3500	300	200	2000	350	175
	1/4-20 1/4-28	-2	5000	500	325	5000	300	325	3000	400	325
	Thread Size	Shank	Installation Force (kN)	Pushout (N)	Torque-out (N•m)	Installation Force (kN)	Pushout (N)	Torque-out (N•m)	Installation Force (kN)	Pushout (N)	Torque-out (N•m)
METRIC (mm)	M3	-1	13.3	1334	9.6	13.3	978	7.3	6.7	956	7.3
		-2	13.3	1334	16.9	13.3	1000	16.9	8.9	1000	9
	M4	-1	13.3	1334	16.9	13.3	1067	12.4	8.9	1112	15.8
		-2	13.3	1779	22.6	15.6	1334	16.9	8.9	1178	16.9
	M5	-1	15.6	1779	16.9	15.6	1334	16.9	8.9	1334	16.9
		-2	15.6	2001	22.6	16.6	1334	22.6	8.9	1556	19.7
M6	-2	22.2	2224	36.7	22.2	1334	36.7	13.3	1779	36.7	

# Self-Clinching Floating Locking Nuts

## Series CFFS & CFFC

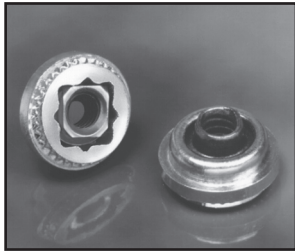
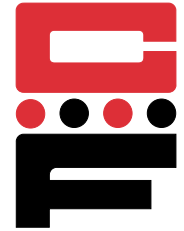

CFFS & CFFC floating clinch nuts provide a self-clinching fastener with a floating nut that compensates for mating misalignments to .030 inches (.8 mm) and provides prevailing torque for the mating screw equivalent to MIL-N-25027 specifications.

Series	Material		Finish	
	Body	Nut	Body	Nut
CFFS	Heat-treated Carbon Steel	300 Series Stainless Steel	Zinc* Clear	Black Dry Film Lubricant (ML)
CFFC	300 Series Stainless Steel	300 Series Stainless Steel	Passivated ASTM A967	Black Dry Film Lubricant (ML)

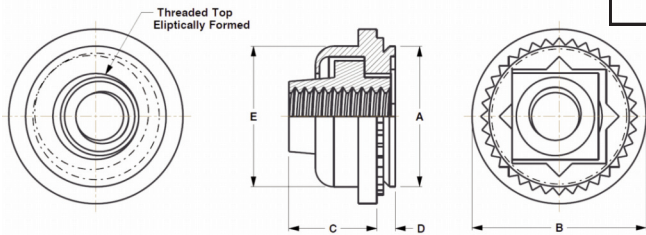

\*See Finish Spec. on Page 6.  
Spec. MIL-L-46010 available

Thread: Self Locking Internal 3B, ANSI B1.1  
(6H, ANSI/ASME B1.13M).

Float: .015 in. (.4mm) minimum in all directions from center, .030 in. (.8mm) total.

Use in: Materials with Rockwell Hardness of B-70 or less.

STARBURST® design indicates genuine Captive self-clinching Floating Nut.

### Dimensions & Specifications

Thread Size	Part Number		D Max	Min.	+0.003 in. (.08mm) - .000(0.00)	A Max	E Max	B ±.015 in. (±.38mm)	C Max	Min.	
	Carbon Steel	Stainless Steel									
INCH (in.)	#4-40	CFFS440-1	CFFC440-1	.038	.038	.290	.289	.290	.36	.130	0.3
		CFFS440-2	CFFC440-2	.054	.054						
	#6-32	CFFS632-1	CFFC632-1	.038	.038	.328	.327	.335	.39	.130	0.32
		CFFS632-2	CFFC632-2	.054	.054						
	#8-32	CFFS832-1	CFFC832-1	.038	.038	.368	.367	.365	.44	.130	0.34
		CFFS832-2	CFFC832-2	.054	.054						
	#10-24	CFFS1024-1	CFFC1024-1	.038	.038	.406	.405	.405	.47	.170	0.36
		CFFS1024-2	CFFC1024-2	.054	.054						
#10-32	CFFS1032-1	CFFC1032-1	.038	.038	.515	.514	.510	.60	.210	0.42	
	CFFS1032-2	CFFC1032-2	.054	.054							
1/4-20	CFFS420-2	CFFC420-2	.054	.054	7.37	7.36	7.337	9.14	3.31	7.62	
	CFFS428-2	CFFC428-2	.054	.054							
METRIC (mm)	M3x0.5	CFFSM3-1	CFFCM3-1	.97	.97	9.35	9.33	9.28	11.18	3.31	8.64
		CFFSM3-2	CFFCM3-2	1.38	1.38						
	M4x0.7	CFFSM4-1	CFFCM4-1	.97	.97	10.31	10.29	10.29	11.94	4.32	9.14
		CFFSM4-2	CFFCM4-2	1.38	1.38						
	M5x0.8	CFFSM5-1	CFFCM5-1	.97	.97	13.08	13.06	12.96	15.24	5.34	10.67
		CFFSM5-2	CFFCM5-2	1.38	1.38						
M6x1.0	CFFSM6-2	CFFCM6-2	1.38	1.38							

All items subject to minimum order requirements.  
\*Not stocked, available on special order.

Continued on next page.



# Self-Clinching Floating Locking Nuts

## Series CFFS & CFFC

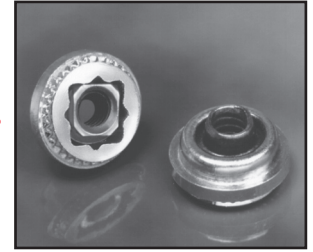

Continued from previous page.

### Installation & Performance Data

Thread Size	Shank	Cold-rolled Steel			2024-T3 Aluminum			5052-H34 Aluminum			
		Installation Force (lbs.)	Pushout (lbs.)	Torque-out (in.-lbs.)	Installation Force (lbs.)	Pushout (lbs.)	Torque-out (in.-lbs.)	Installation Force (lbs.)	Pushout (lbs.)	Torque-out (in.-lbs.)	
INCH (in.)	#4-40	-1	3000	300	85	3000	220	65	1500	215	65
		-2	3000	300	150	3000	225	150	2000	225	80
	#6-32	-1	3000	300	150	3000	235	110	2000	240	140
		-2	3000	300	175	3000	275	150	2000	250	150
	#8-32	-1	3000	300	150	3000	240	110	2000	250	140
		-2	3000	400	200	3000	300	150	2000	265	150
	#10-24	-1	3500	400	150	3500	300	150	2000	300	150
		-2	3500	450	200	3500	300	200	2000	350	175
#10-32	-1	3500	400	150	3500	300	150	2000	300	150	
	-2	3500	450	200	3500	300	200	2000	350	175	
1/4-20 1/4-28	-2	5000	500	325	5000	300	325	3000	400	325	
Thread Size	Shank	Installation Force (kN)	Pushout (N)	Torque-out (N•m)	Installation Force (kN)	Pushout (N)	Torque-out (N•m)	Installation Force (kN)	Pushout (N)	Torque-out (N•m)	
METRIC (mm)	M3	-1	13	1334	9.6	13.3	978	7.3	6.7	956	7.3
		-2	13	1334	16.9	13.3	1000	16.9	8.9	1000	9
	M4	-1	13	1334	16.9	13.3	1067	12.4	8.9	1112	15.8
		-2	13	1779	22.6	15.6	1334	16.9	8.9	1178	16.9
	M5	-1	15	1779	16.9	15.6	1334	16.9	8.9	1334	16.9
		-2	15	2001	22.6	16.6	1334	22.6	8.9	1556	19.7
M6	-2	22	2224	36.7	22.2	1334	36.7	13.3	1779	36.7	



# Self-Clinching Nuts for Stainless Steel

## Series CFSP

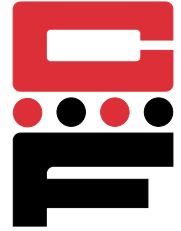

CFSP self-clinching nuts provide strong load-bearing threads in stainless sheet metal as thin as .030 inches (.8mm).

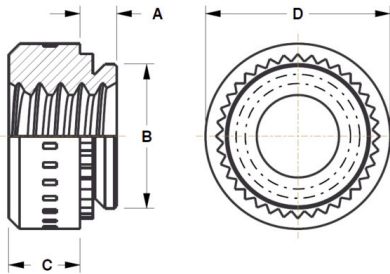

Series	Material	Finish
CFSP	Precipitation Hardened Stainless Steel	Passivated ASTM A967

Thread: Internal 2B, ANSI B1.1 (6H, ANSI/ASME B1.13M).

Use in: Materials with Rockwell Hardness of B-90 or less.

### Dimensions & Specifications

	Thread Size	Part Number	A Max.	Min.	+0.003 in. (.08 mm) -0.000 (.00)	B Max.	C ±.01 in. (±.25mm)	D ±.01 in. (±.25mm)	Min.
INCH (in.)	#4-40	CFSP440-0	.030	.030-.039	.166	.165	.07	.25	.19
		CFSP440-1	.038	.040					
		CFSP440-2	.054	.056					
	#6-32	CFSP632-0	.030	.030-.039	.1875	.187	.07	.28	.22
		CFSP632-1	.038	.040					
		CFSP632-2	.054	.056					
	#8-32	CFSP832-0	.030	.030-.039	.213	.212	.09	.31	.27
		CFSP832-1	.038	.040					
		CFSP832-2	.054	.056					
	#10-32	CFSP1032-0	.030	.030-.039	.250	.249	.09	.34	.28
		CFSP1032-1	.038	.040					
		CFSP1032-2	.054	.056					
1/4-20	CFSP420-1	.054	.056	.344	.343	.17	.44	.34	
	CFSP420-2	.087	.090						
METRIC (mm)	M3 x 0.5	CFSPM3-0	.77	.8-1	4.22	4.2	1.5	6.35	4.8
		CFSPM3-1	.97	1.0					
		CFSPM3-2	1.38	1.4					
	M4 x 0.7	CFSPM4-0	.77	.8-1	5.41	5.38	2	7.87	6.9
		CFSPM4-1	.97	1.0					
		CFSPM4-2	1.38	1.4					
	M5 x 0.8	CFSPM5-0	.77	.8-1	6.35	6.33	2	8.75	7.1
		CFSPM5-1	.97	1.0					
		CFSPM5-2	1.38	1.4					
	M6 x 1.0	CFSPM6-1	1.38	1.4	8.75	8.73	4.08	11.1	8.6

Continued on next page.



# Self-Clinching Nuts for Stainless Steel Series CFSP



Continued from previous page.

## Installation & Performance Data

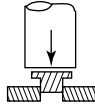
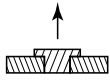
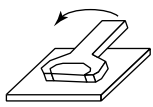
					
	Thread Size	Shank Code	Installation Force (lbs.)	Pushout (lbs.)	Torque-out (in.-lbs.)
INCH (in.)	#4-40	-0	8000	130	14
		-1	9000	165	17
		-2	10000	290	18
	#6-32	-0	8500	140	18
		-1	9500	170	24
		-2	10500	340	28
	#8-32	-0	9000	145	30
		-1	10000	180	37
		-2	11000	360	45
	#10-32	-0	9500	180	35
		-1	10500	230	45
		-2	11500	400	60
1/4-20	-1	13500	450	150	
	-2	13500	600	170	
	Thread Size	Shank Code	Installation Force (kN)	Pushout (N)	Torque-out (N•m)
METRIC (mm)	M3	-0	35.6	575	1.58
		-1	40	725	1.92
		-2	44.5	1290	2.03
	M4	-0	40	645	3.38
		-1	44.5	800	4.18
		-2	49	1600	5.08
	M5	-0	42.3	800	3.95
		-1	46.7	1025	5.08
		-2	51.2	1775	6.77
	M6	-1	60	2000	17

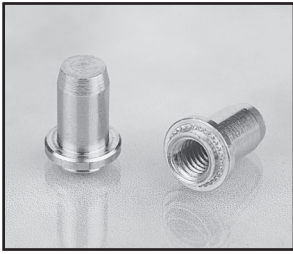

# Self-Clinching Blind Press Nuts

## Series CFB & CFBS

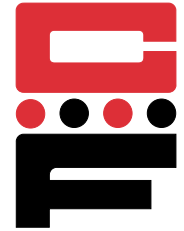

CFB & CFBS blind, sealed-thread, press nuts are designed to provide extended thread lengths in thin sheet metal. Press nuts provide a seal against the entrance of dirt, oils, moisture, and corrosive atmospheres. They are usually more economical to use than nut and screw-type hardware that require elaborate seals and special assembly procedures.

Series	Material	Finish
CFB	Heat-treated Carbon Steel	Zinc* Clear
CFBS	300 Series Stainless Steel	Passivated ASTM A967

\*See Finish Spec. on Page 6.

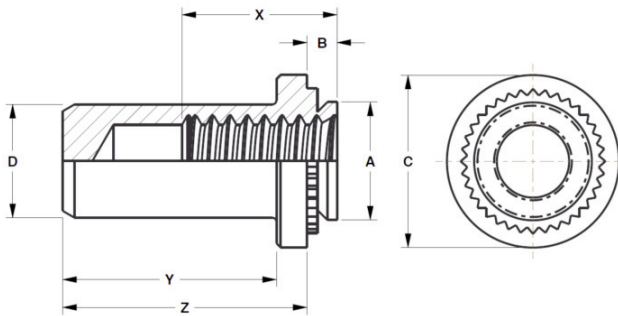

Thread: Internal 2B, ANSI B1.1  
(6H, ANSI/ASME B1.13M).

Use In: CFB – Materials with HRB-80 or less.  
CFBS – Materials with HRB-70 or less.

### Dimensions & Specifications

Thread Size	Part Number		Barrel Dia. D Max.	Min.	+ .003 in. (.08 mm) - .000 (.00)	Shank Dia A Max.	Y Max	B Max	C ±.01 in. (±.25mm)	Z ±.01 in. (±.25mm)	Min.	X Depth Full Thread Min.
	Carbon Steel	Stainless Steel										
INCH (in.)	440	CFB440-1	.149	.040	.166	.165	.335	.038	.25	.38	.19	.21
		CFB440-2		CFBS440-2				.056				
	632	CFB632-1	.169	.040	.187	.186	.335	.038	.28	.38	.22	.23
		CFB632-2		CFBS632-2				.056				
	832	CFB832-1	.204	.040	.213	.212	.385	.038	.31	.44	.27	.28
		CFB832-2		CFBS832-2				.056				
1032	CFB1032-1	.235	.040	.250	.249	.385	.038	.34	.44	.28	.28	
	CFB1032-2		CFBS1032-2				.056					.054
1/4-20	CFB420-1	.305	.056	.344	.343	.500	.054	.43	.56	.34	.31	
	CFB420-2		CFBS420-2				.090					.087
METRIC (mm)	M3X0.5	CFBM3-1	3.8	1.0	4.25	4.22	8.5	.97	6.35	9.6	4.8	5.3
		CFBM3-2		CFBSM3-2				1.4				
	M4X0.7	CFBM4-1	5.2	1.0	5.4	5.38	9.87	.97	7.95	11.2	6.9	7.1
		CFBM4-2		CFBSM4-2				1.4				
	M5X0.8	CFBM5-1	6.0	1.0	6.4	6.38	9.8	.97	8.75	11.2	7.1	7.1
		CFBM5-2		CFBSM5-2				1.4				
	M6X1.0	CFBM6-1	7.8	1.4	8.75	8.75	12.7	1.37	11.10	14.3	8.6	7.8
		CFBM6-2		CFBSM6-2				2.3				

Continued on next page.



# Self-Clinching Blind Press Nuts Series CFB & CFBS



Continued from previous page.

## Installation & Performance Data

	Thread Size	Shank Code	Min.	Cold Rolled Steel			5052-H34 Aluminum		
				Installation Force (lbs.)	Pushout (lbs.)	Torque Out (in.lbs.)	Installation Force (lbs.)	Pushout (lbs.)	Torque Out (in.lbs.)
INCH (in.)	#4-40	-1	.040	2500	125	13	1600	90	10
		-2	.056	3500	230	18	2000	170	13
	#6-32	-1	.040	3000	130	18	1800	95	17
		-2	.056	4000	260	28	2800	190	22
	#8-32	-1	.040	3500	135	30	2000	105	23
-2		.056	5000	285	45	3000	220	35	
#10-32	-1	.040	4000	140	35	2100	110	32	
	-2	.056	5000	250	60	3500	190	50	
1/4-20	-1	.056	6000	400	105	4000	315	90	
	-2	.090							
	Thread Size	Shank Code	Min.	Cold Rolled Steel			5052-H34 Aluminum		
				Installation Force (kN)	Pushout (N)	Torque Out (N•m)	Installation Force (kN)	Pushout (N)	Torque Out (N•m)
METRIC (mm)	M3	-1	1	11.1	550	1.5	7.1	400	1.15
		-2	1.4	14	1010	2.05	9	750	1.47
	M4	-1	1	15.6	600	3.4	8.9	470	2.6
		-2	1.4	20	1250	5.1	12.5	970	4
	M5	-1	1	17.8	620	5	9.3	480	3.6
		-2	1.4	25	1112	6.8	14	845	5.7
	M6	-1	1.4	25.7	1760	11.9	17.8	1400	10.2
		-2	2.3						





# Self-Clinching Nuts

## Series C & CS

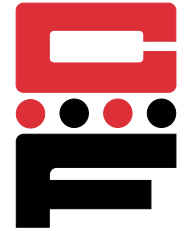

C & CS nuts provide strong load-bearing threads in sheet metal and other thin section assemblies. Some C & CS nuts meet specification features of NASM45938/1.

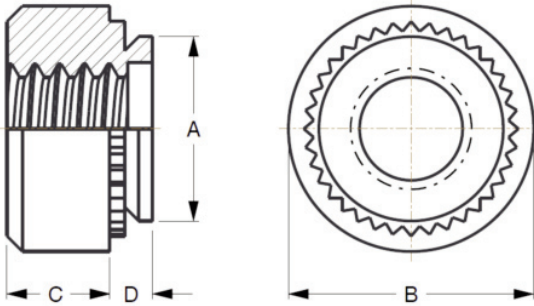

Series	Material	Finish
C	Heat-treated Carbon Steel	Zinc* Clear
CS	300 Series Stainless Steel	Passivated ASTM A967

\*See Finish Spec. on Page 6.

Thread: Internal 2B, ANSI B1.1 (6H, ANSI/ASME B1.13M).

Use In: C – Materials with HRB-80 or less.

CS – Materials with HRB-70 or less.

### Dimensions & Specifications

Thread Size	Part Number		D Max.	Min.	+.003 in. -.000	A Max.	B ±.01 in.	C ±.01 in.	Min.
	Carbon Steel	Stainless Steel							
#2-56	C256-0	CS256-0	.030	.030	.166	.165	.250	.070	.19
	C256-1	CS256-1	.038	.040					
	C256-2	CS256-2	.054	.056					
	C256-3	CS256-3	.087	.090					
#3-48	C348-0	CS348-0	.030	.030	.166	.165	.250	.070	.19
	C348-1	CS348-1	.038	.040					
	C348-2	CS348-2	.054	.056					
	C348-3	CS348-3	.087	.090					
#4-40	C440-0	CS440-0	.030	.030	.166	.165	.250	.070	.19
	C440-1	CS440-1	.038	.040					
	C440-2	CS440-2	.054	.056					
	C440-3	CS440-3	.087	.090					
#6-32	C632-0	CS632-0	.030	.030	.1875	.187	.280	.070	.22
	C632-1	CS632-1	.038	.040					
	C632-2	CS632-2	.054	.056					
	C632-3	CS632-3	.087	.090					
#8-32	C832-0	CS832-0	.030	.030	.213	.212	.310	.090	.27
	C832-1	CS832-1	.038	.040					
	C832-2	CS832-2	.054	.056					
	C832-3	CS832-3	.087	.090					

Continued on next page.



# Self-Clinching Nuts

## Series C & CS

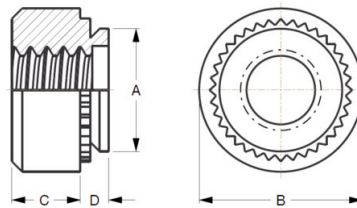
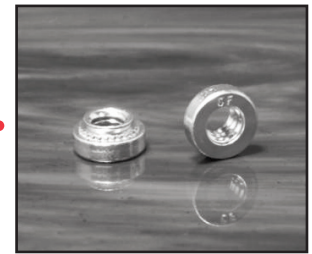

Continued from previous page.

### Dimensions & Specifications

Thread Size	Part Number		D Max.	Min.	+0.003 in. -.000	A Max.	B ±.01 in.	C ±.01 in.	Min.
	Carbon Steel	Stainless Steel							
#10-24	C1024-0	CS1024-0	.030	.030	.250	.249	.340	.090	.28
	C1024-1	CS1024-1	.038	.040					
	C1024-2	CS1024-2	.054	.056					
	C1024-3	CS1024-3	.087	.090					
#10-32	C1032-0	CS1032-0	.030	.030	.250	.249	.340	.090	.28
	C1032-1	CS1032-1	.038	.040					
	C1032-2	CS1032-2	.054	.056					
	C1032-3	CS1032-3	.087	.090					
#12-24	C1224-1	CS1224-1	.038	.040	.277	.276	.370	.130	.31
	C1224-2	CS1224-2	.054	.056					
	C1224-3	CS1224-3	.087	.090					
1/4-20	C420-0	CS420-0	.045	.047	.344	.343	.440	.170	.34
	C420-1	CS420-1	.054	.056					
	C420-2	CS420-2	.087	.090					
	C420-3	CS420-3	.120	.125					
1/4-28	C428-1	CS428-1	.054	.056	.344	.343	.440	.170	.34
	C428-2	CS428-2	.087	.090					
	C428-3	CS428-3	.120	.125					
5/16-18	C518-1	CS518-1	.054	.056	.413	.412	.500	.230	.38
	C518-2	CS518-2	.087	.090					
	C518-3	CS518-3	.120	.125					
5/16-24	C524-1	CS524-1	.054	.056	.413	.412	.500	.230	.38
	C524-2	CS524-2	.087	.090					
	C524-3	CS524-3	.120	.125					
3/8-16	C616-1	CS616-1	.087	.090	.500	.499	.560	.270	.44
	C616-2	CS616-2	.120	.125					
	C616-3	CS616-3	.235	.250					
3/8-24	C624-1	CS624-1	.087	.090	.500	.499	.560	.270	.44
	C624-2	CS624-2	.120	.125					
	C624-3	CS624-3	.235	.250					
1/2-13	C813-1	CS813-1	.120	.125	.656	.655	.810	.360	.63
	C813-2	CS813-2	.235	.250					

Continued on next page.



# Self-Clinching Nuts

## Series C & CS

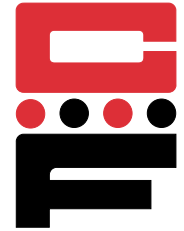

Continued from previous page.

### Dimensions & Specifications

Thread Size	Part Number		D Max.	Min.	+0.08 mm -0.00	A Max.	B ±.25 mm	C ±.25 mm	Min.
	Carbon Steel	Stainless Steel							
M2 x 0.4	CM2-0	CSM2-0	.77	.8	4.22	4.20	6.35	1.5	4.8
	CM2-1	CSM2-1	.97	1.0					
	CM2-2	CSM2-2	1.38	1.4					
	CM2-3	CSM2-3	2.21	2.29					
M2.5 x 0.45	CM2.5-0	CSM2.5-0	.77	.8	4.22	4.20	6.35	1.5	4.8
	CM2.5-1	CSM2.5-1	.97	1.0					
	CM2.5-2	CSM2.5-2	1.38	1.4					
	CM2.5-3	CSM2.5-3	2.21	2.29					
M3 x 0.5	CM3-0	CSM3-0	.77	.8	4.22	4.20	6.35	1.5	4.8
	CM3-1	CSM3-1	.97	1.0					
	CM3-2	CSM3-2	1.38	1.4					
	CM3-3	CSM3-3	2.21	2.29					
M3.5 x 0.6	CM3.5-0	CSM3.5-0	.77	.8	4.75	4.73	7.11	1.5	5.6
	CM3.5-1	CSM3.5-1	.97	1.0					
	CM3.5-2	CSM3.5-2	1.38	1.4					
	CM3.5-3	CSM3.5-3	2.21	2.29					
M4 x 0.7	CM4-0	CSM4-0	.77	.8	5.41	5.38	7.87	2.0	6.9
	CM4-1	CSM4-1	.97	1.0					
	CM4-2	CSM4-2	1.38	1.4					
	CM4-3	CSM4-3	2.21	2.29					
M5 x 0.8	CM5-0	CSM5-0	.77	.8	6.35	6.33	8.64	2.0	7.1
	CM5-1	CSM5-1	.97	1.0					
	CM5-2	CSM5-2	1.38	1.4					
	CM5-3	CSM5-3	2.21	2.29					
M6 x 1.0	CM6-0	CSM6-0	1.15	1.2	8.75	8.73	11.18	4.08	8.6
	CM6-1	CSM6-1	1.38	1.4					
	CM6-2	CSM6-2	2.21	2.29					
	CM6-3†	CSM6-3	3.05	3.18					
M8 x 1.25	CM8-1	CSM8-1	1.38	1.4	10.5	10.47	12.7	5.47	9.7
	CM8-2	CSM8-2	2.21	2.29					
	CM8-3†	CSM8-3	3.05	3.2					
M10 x 1.5	CM10-1	CSM10-1	2.21	2.29	14.0	13.97	17.35	7.48	13.5
	CM10-2	CSM10-2	3.05	3.18					
	CM10-3†	CSM10-3†	6.00	6.4					
M12 x 1.75	CM12-1†	CSM12-1†	3.05	3.18	17.0	16.95	20.57	8.5	16
	CM12-2†	CSM12-2†	6.00	6.4					

†Not stocked, available upon special order.

Continued on next page.



# Self-Clinching Nuts

## Series C & CS

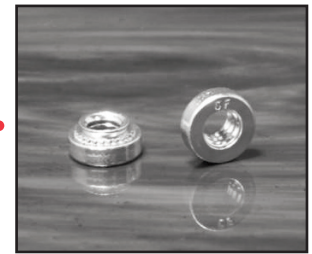

Continued from previous page.

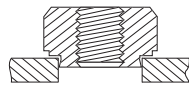

Fastener Must Be Installed  
Squarely In Hole

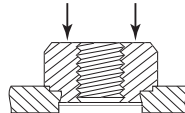

Squeezing Force Is Applied  
To Head Of Fastener

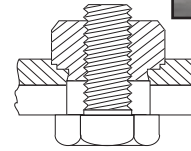

Install Bolt Or Screw  
From Opposite Side  
Of Head Of Fastener

### Installation & Performance Data

Thread Size	Shank Code	Cold-rolled Steel			5052-H34 Aluminum		
		Installation Force (lbs.)	Pushout (lbs.)	Torque-out (in.-lbs.)	Installation Force (lbs.)	Pushout (lbs.)	Torque-out (in.-lbs.)
#2-56 #3-48 #4-40	-0	2500-3500	105	13	1500-2000	63	8
	-1		125	15		90	10
	-2		230	18		170	13
	-3		230	18		170	13
#6-32	-0	3000-6000	110	16	2500-3000	63	16
	-1		130	20		95	17
	-2		275	28		190	22
	-3		275	28		190	22
#8-32	-0	4000-6000	110	26	2500-3000	68	21
	-1		145	35		105	23
	-2		285	45		220	35
	-3		285	45		220	35
#10-24 #10-32	-0	4000-9000	120	30	2500-3000	68	20
	-1		180	40		110	32
	-2		320	60		190	50
	-3		320	60		225	50
#12-24	-1	5000-6500	200	74	2500-6500	120	63
	-2		350	80		285	70
	-3		350	80		285	70
1/4-20 1/4-28	-0	6000-8000	315	115	4000-7000	220	70
	-1		400	150		360	90
	-2-3		400	150		360	125
5/16-18 5/16-24	-1	6000-8000	420	165	4000-7000	380	120
	-2-3		420	180		380	160
3/8-16 3/8-24	-1-2-3	7000-11000	460	320	5000-8000	400	270
	-1-2		10000-15000	1050		735	7000-9000

Continued on next page.

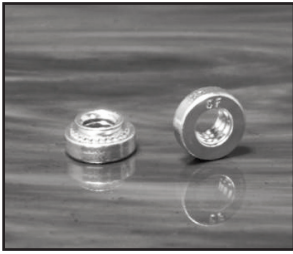

# Self-Clinching Nuts

## Series C & CS

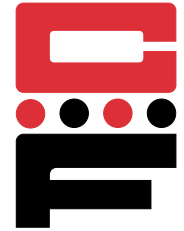

Continued from previous page.

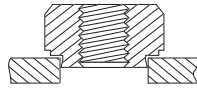

Fastener Must Be Installed  
Squarley In Hole

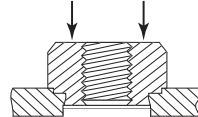

Squeezing Force Is Applied  
To Head Of Fastener

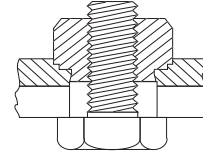

Install Bolt Or Screw  
From Opposite Side  
Of Head Of Fastener

### Installation & Performance Data

Thread Size	Shank Code	Cold-rolled Steel			5052-H34 Aluminum		
		Installation Force (kN)	Pushout (N)	Torque-out (N·m)	Installation Force (kN)	Pushout (N)	Torque-out (N·m)
M2 x 0.4 M2.5 x 0.45 M3 x 0.5	-0	11.2-15.6	470	1.47	6.7-8.9	280	.9
	-1		550	1.7		400	1.13
	-2		1010	2.03		750	1.47
	-3		1100	2.0		850	1.47
M3.5 x 0.6	-0	13.4-26.7	480	1.8	11.2-13.5	280	1.8
	-1		570	2.3		400	1.92
	-2		1210	2.3		840	2.5
	-3		1300	2.5		1050	2.8
M4 x 0.7	-0	18-27	490	2.95	11.2-13.4	300	2.37
	-1		645	4		470	2.6
	-2		1250	5.1		970	4.0
	-3		1300	4.2		1100	4.0
M5 x 0.8	-0	18-38	530	3.6	11.2-15.6	300	3.0
	-1		800	4.5		480	3.6
	-2		1420	6.8		845	5.7
	-3		1500	6.0		1225	5.7
M6 x 1.0	-0	27-36	1380	13	18-32	970	7.9
	-1-2-3		1760	17		1580	10.2 / 14.1
M8 x 1.25	-1-2-3	27-36	1870	18.7 / 20.3	18-32	1570	13.6 / 18.1
M10 x 1.5	-1-2-3	32-50	2020	36.2	22-36	1760	32.7
M12 x 1.75	-1-2	33-49	3065	73.9	23-30	1390	35.2

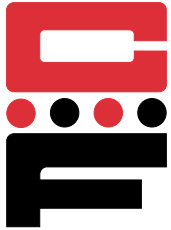

# Self-Clinching Steel Heavy Duty Nuts

## Series CFH & CFHN



CFH nut fasteners are available in both heat-treated and non-heat-treated versions, offering an opportunity to up-grade fastening quality with appreciable cost reduction over weld nuts.

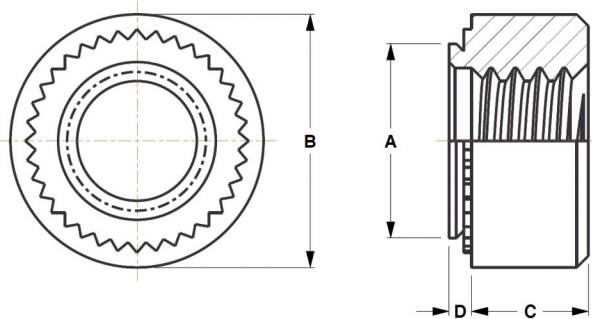

Series	Material	Finish
CFH-X	Heat-treated	None
CFH-ZI	Carbon Steel	Zinc* Clear
CFHN-X	Non-Heat-treated	None
CFHN-ZI	Carbon Steel	Zinc* Clear

\*See Finish Spec. on Page 6.

Thread: Internal 2B, ANSI B1.1  
(6H, ANSI/ASME B1.13M).

Use in: CFH-materials with Rockwell Hardness of B-80 or less.  
CFHN -materials with Rockwell Hardness of B-60 or less.

Part Number Structure:

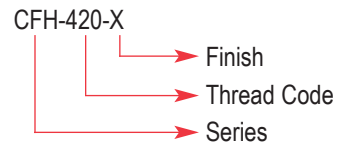

### Dimensions & Specifications

	Thread Size	Part Number		D Max.	Min.	+.005 in. (.13mm) -.000(.00)	A Max.	B ±.01 in. (±.25 mm)	C ±.005 in. (±.13 mm)	Min.
		Heat Treated	Non-Heat Treated							
INCH	1/4-20	CFH420	CFHN420	.058	.058	.344	.343	.500	.189	.380
METRIC	M6 x 1.0	CFHM6	CFHNM6	1.48	1.48	8.75	8.72	12.7	5.0	10.0

### Installation & Performance Data

	Thread Size	Material	Panel Thickness	Installation Force	Pushout	Torque-out
INCH	1/4-20	Cold-rolled Steel	.060 in.	4800 lbs.	450 lbs.	120 in.-lbs.
		Aluminum	.062 in.	3500 lbs.	370 lbs.	110 in.-lbs.
METRIC	M6	Cold-rolled Steel	2.24 mm	33 kN	2020 N	23.5 N•m
		Aluminum	2.29 mm	22 kN	1760 N	21.5 N•m

# Self-Clinching Aluminum Nuts

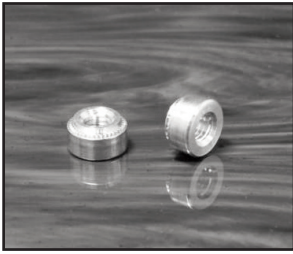
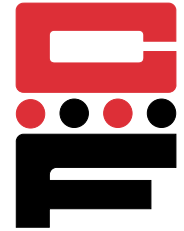

## Series CA-Aluminum

CA aluminum self-clinching nuts provide strong load-bearing threads. All Captive Fastener self-clinching nuts fit standard hole sizes and are dimensionally identical to industry standards.

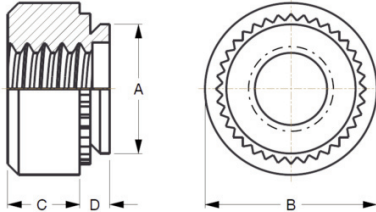

Series	Material	Finish
CA	2024-T4 Aluminum	None

Thread: Internal 2B, ANSI B1.1 (6H, ANSI/ASME B1.13M).  
 Use in: Materials with Rockwell Hardness of B-50 or less.

### Dimensions & Specifications

	Thread Size	Part Number	D Max.	Min.	+0.003 in. (+.08 mm) -0.000 (-.00)	A Max.	B ±.01 in. (±.25 mm)	C ±.01 in. (±.25 mm)	Min.
INCH (in.)	#2-56	CA256-1	.038	.040	.166	.165	.25	.07	.19
		CA256-2	.054	.056					
	#4-40	CA440-1	.038	.040	.1875	.187	.25	.09	.22
		CA440-2	.054	.056					
	#6-32	CA632-1	.038	.040	.213	.212	.28	.09	.27
		CA632-2	.054	.056					
	#8-32	CA832-1	.038	.040	.234	.233	.31	.13	.28
		CA832-2	.054	.056					
	#10-24	CA1024-1	.038	.040	.296	.295	.370	.16	.31
		CA1024-2	.054	.056					
#10-32	CA1032-1	.038	.040	.296	.295	.370	.16	.31	
	CA1032-2	.054	.056						
1/4-20	CA420-1	.054	.056	.344	.343	.44	.17	.34	
	CA420-2	.087	.091						
	CA420-3	.120	.125						
METRIC (mm)	M2 x 0.4	CAM2-1	.98	1.0	4.22	4.2	6.35	1.5	4.8
		CAM2-2	1.38	1.4					
	M3 x 0.5	CAM3-1	.98	1.0	4.75	4.73	6.35	2.0	5.6
		CAM3-2	1.38	1.4					
	M3.5 x 0.6	CAM3.5-1	.98	1.0	5.41	5.38	7.11	2.0	6.9
		CAM3.5-2	1.38	1.4					
	M4 x 0.7	CAM4-1	.98	1.0	5.94	5.92	7.8	3.0	7.1
		CAM4-2	1.38	1.4					
	M5 x 0.8	CAM5-1	.98	1.0	7.52	7.49	9.4	3.8	7.9
		CAM5-2	1.38	1.4					
	M6 x 1.0	CAM6-1	1.38	1.4	8.75	8.73	11.18	4.08	8.6
		CAM6-2	2.21	2.3					



# Self-Clinching KAL Hex Nuts

## Series CKN

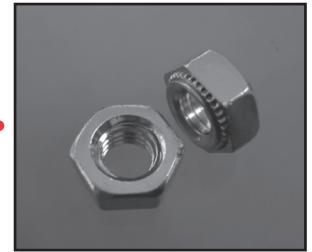

CKN self-clinching KAL-nuts provide strong internal threads in sheet material as thin as 1 mm.

Series	Material	Finish
CKN	Heat-treated Carbon Steel	Zinc* Clear

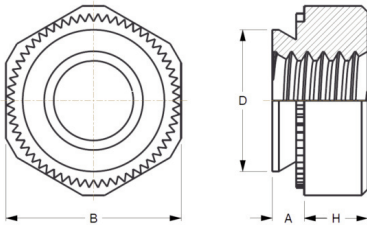

\*See Finish Spec. on Page 6.

Thread: Internal 6H, ANSI/ASME B1.13.

Use in: CKN – Materials with Rockwell Hardness of HRB-80 or less.

### Dimensions & Specifications

Thread Size	Part Number Carbon Steel	D Max	B +0.00 -0.20	H ±0.10	A Max.			
						Min.	+0.08 -0.00	Min.
M3 x 0.5	CKNM3-1	4.45	5.5	2.0	1.0	1.0	4.5	4.5
	CKNM3-2							
M4 x 0.7	CKNM4-1	5.45	7.0	2.2	1.0	1.0	5.5	5.5
	CKNM4-2							
M5 x 0.8	CKNM5-1	6.45	8.0	3.0	1.0	1.0	6.5	6.5
	CKNM5-2							
M6 x 1.0	CKNM6-1	7.95	10.0	4.0	1.0	1.0	8.0	8.0
	CKNM6-2							
M8 x 1.25	CKNM8-2	9.95	13.0	4.5	1.4	1.4	10.0	10.0
	CKNM8-3							

### Installation & Performance Data

Thread Size	Shank	Min. Sheet	Cold-rolled Steel			5052-H34 Aluminum		
			Installation Force (kN)	Pushout (N)	Torque-out (N•m)	Installation Force (kN)	Pushout (N)	Torque-out (N•m)
M3 x 0.5	-1	1.0	11.7	490	1.96	5.8	290	1.17
	-2	1.4	12.7	780	2.45	6.8	580	1.47
M4 x 0.7	-1	1.0	12.7	580	2.94	7.8	390	1.96
	-2	1.4	13.7	880	3.92	9.8	680	2.94
M5 x 0.8	-1	1.0	13.7	680	3.92	8.8	440	2.94
	-2	1.4	14.7	980	4.9	10.7	730	3.92
M6 x 1.0	-1	1.0	16.6	880	7.84	11.7	580	5.88
	-2	1.4	19.6	1270	11.76	13.7	880	7.84
M8 x 1.25	-2	1.4	24.5	1370	15.69	15.6	1070	9.80
	-3	2.0	29.4	1760	19.61	17.6	1370	11.76



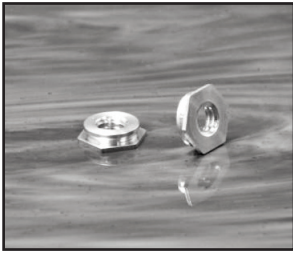

# Self-Clinching Flush Nuts

## Series CFL

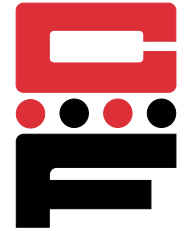

CFL flush nuts offer the advantage of being completely flush within the sheet while providing load-bearing threads in materials too ductile to tap. All dimensions are identical to industry standards.

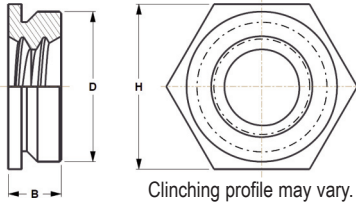

Series	Material	Finish
CFL	300 Series Stainless Steel	Passivated ASTM A967

Thread: Internal 2B, ANSI B1.1 (6H, ANSI/ASME B1.13M)  
 Use in: Materials with Rockwell Hardness of B-70 or less.

### Dimensions & Specifications

	Thread Size	Part Number	D Max.	Min.		H Nom.	B Max.	Min.
INCH (in.)	#2-56	CFL256-1	.171	.060	.172	.188	.060	.23
		CFL256-2		.091				
	#4-40	CFL440-1	.171	.060	.172	.188	.060	.23
		CFL440-2		.091				
	#6-32	CFL632-1	.212	.060	.213	.25	.060	.27
		CFL632-2		.091				
	#8-32	CFL832-1	.289	.060	.290	.312	.060	.28
		CFL832-2		.091				
	#10-24	CFL1024-1	.311	.060	.312	.343	.060	.31
		CFL1024-2		.091				
	#10-32	CFL1032-1	.311	.060	.312	.343	.060	.31
		CFL1032-2		.091				
	1/4-20	CFL420-3	.343	.125	.344	.375	.120	.34
		CFL420-4		.156				
CFL420-5		.187						
1/4-28	CFL428-3	.343	.125	.344	.375	.120	.34	
	CFL428-4		.156					
	CFL428-5		.187					
METRIC (mm)	M2 x 0.4	CFLM2-1	4.35	1.53	4.37	4.8	1.53	6.0
		CFLM2-2		2.3				
	M2.5 x .45	CFLM2.5-1	4.35	1.53	4.37	4.8	1.53	6.0
		CFLM2.5-2		2.3				
	M3 x 0.5	CFLM3-1	4.35	1.53	4.37	4.8	1.53	6.0
		CFLM3-2		2.3				
	M3.5 x 0.6	CFLM3.5-1	5.35	1.53	5.4	6.4	1.53	6.5
		CFLM3.5-2		2.3				
	M4 x 0.7	CFLM4-1	7.35	1.53	7.37	7.9	1.53	7.2
		CFLM4-2		2.3				
	M5 x 0.8	CFLM5-1	7.9	1.53	7.92	8.7	1.53	8.0
		CFLM5-2		2.3				
	M6 x 1.0	CFLM6-3	8.72	3.18	8.74	9.5	3.05	8.8
		CFLM6-4		3.96				
CFLM6-5		4.75						

Continued on next page.



# Self-Clinching Flush Nuts

## Series CFL

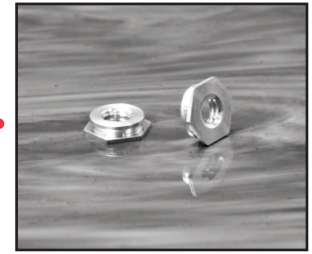

Continued from previous page.

### Installation & Performance Data

	Part Number	Max. Screw torque (in.-lbs.)	Cold-rolled Steel		5052-H34 Aluminum	
			Installation Force (lbs.)	Pushout (lbs.)	Installation Force (lbs.)	Pushout (lbs.)
INCH (in.)	CFL256-1	1.5	3000	200	2000	200
	CFL256-2	1.5	3000	200	2000	200
	CFL440-1	2.5	3000	200	2000	200
	CFL440-2	2.5	3000	200	2000	200
	CFL632-1	3.5	3000	200	2000	200
	CFL632-2	3.5	3000	200	2000	200
	CFL832-1	5.25	4000	240	2000	240
	CFL832-2	5.25	4000	240	2000	240
	CFL1024-1	7.5	4000	240	4000	240
	CFL1024-2	7.5	4000	240	4000	240
	CFL1032-1	7.5	4000	240	4000	240
	CFL1032-2	7.5	4000	240	4000	240
	CFL420-3,4,5	36	4500	840	3500	640
	CFL428-3,4,5	36	4500	840	3500	640
	Part Number	Max. Screw Torque (N·m)	Installation Force (kN)	Pushout (kN)	Installation Force (kN)	Pushout (kN)
METRIC (mm)	CFLM2-1	.16	13.3	.890	8.9	.890
	CFLM2-2	.16	13.3	.890	8.9	.890
	CFLM2.5-1	.23	13.3	.890	8.9	.890
	CFLM2.5-2	.23	13.3	.890	8.9	.9
	CFLM3-1,2	.36	13.3	.890	8.9	.890
	CFLM3.5-1,2	.4	15	1.0	8.9	.9
	CFLM4-1,2	1	17.8	1.068	17.8	1.068
	CFLM5-1,2	1.3	17.8	1.068	17.8	1.068
	CFLM6-3,4,5	4.5	20	3.736	20	3.736



# Self-Clinching Miniature Self Locking Nuts

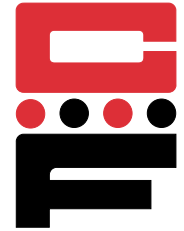

## Series CFE & CFEO Self-Locking Threads CFEX & CFEOX Non-Locking Threads

CFE self-clinching fasteners are designed to provide strong threads in a minimum of space. They are available with locking and non-locking threads and are directly interchangeable with industry standards.

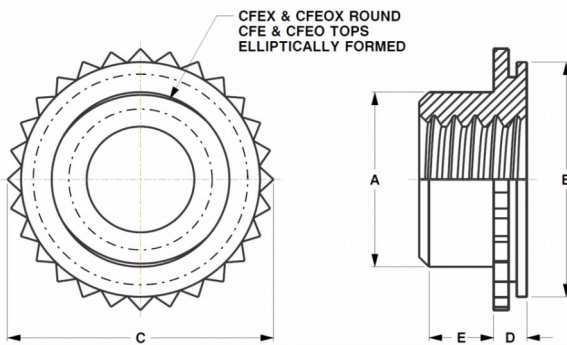

Series	Finish	Thread
CFE,CFEO	Black Dry Film Lubricant (ML)	Self-Locking Internal 3B, ANSI B1.1 (6H,ANSI/ASME B1.13M)
CFEX,CFEOX	Passivated ASTM A967	Non-Locking Internal 2B, ANSI B1.1 (6H,ANSI/ASME B1.13M)

Material: 300 Series Stainless Steel.

Use in: Materials with Rockwell Hardness of B-70 or less.

Note: Thread locking performance for CFE & CFEO is equivalent to applicable NASM25027 specifications.

### Dimensions & Specifications

Thread Size	Part Number		D Max.	Min.	+0.003 in. (.08 mm) -0.000(.00)	A Max.	E +0.015 in. (.4 mm) -0.000(.00)	B Max.	C ±.005 in. (.13 mm)	Min.	
	Self-Locking	Non-Locking									
INCH (in.)	#4-40	CFE440	CFEX440	.060	.059	.172	.145	.065	.171	.192	.14
		CFEO440	CFEOX440	.040	.039						
	#6-32	CFE632	CFEX632	.060	.059	.213	.180	.075	.212	.244	.17
		CFEO632	CFEOX632	.040	.039						
	#8-32	CFE832	CFEX832	.060	.059	.290	.215	.090	.289	.322	.20
		CFEO832	CFEOX832	.040	.039						
#10-32	CFE1032	CFEX1032	.060	.059	.290	.245	.110	.289	.322	.20	
	CFEO1032	CFEOX1032	.040	.039							
1/4-20	CFE420	CFEX420 <sup>†</sup>	.060	.059	.344	.318	.120	.343	.384	.28	
1/4-28	CFE428	CFEX428 <sup>†</sup>	.060	.059							
METRIC (mm)	M3 x 0.5	CFEOM3	CFEOXM3	1.02	.99	4.39	3.96	1.90	4.37	4.88	3.6
		CFEM3	CFEXM3	1.53	1.5						
	M4 x 0.7	CFEOM4	CFEOXM4	1.02	.99	7.39	5.23	2.55	7.37	8.17	5.2
		CFEM4	CFEXM4	1.53	1.5						
	M5 x 0.8	CFEOM5	CFEOXM5	1.02	.9	7.39	6.48	3.05	7.37	8.17	5.2
		CFEM5	CFEXM5	1.53	1.5						
M6 x 1.0	CFEM6	CFEXM6	1.53	1.5	8.74	7.72	3.30	8.72	9.74	7.1	

<sup>†</sup>Not Stocked, available on special order.

Continued on next page.

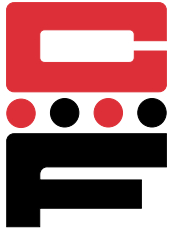

# Self-Clinching Miniature Self Locking Nuts



## Series CFE & CFEO Self-Locking Threads CFEX & CFEOX Non-Locking Threads

Continued from previous page.

### Installation & Performance Data

Thread Size	Series	Sheet Thickness (in.)	Cold-rolled Steel			5052-H34 Aluminum			
			Installation Force (lbs.)	Pushout (lbs.)	Torque-out (in.-lbs.)	Installation Force (lbs.)	Pushout (lbs.)	Torque-out (in.-lbs.)	
INCH (in.)	#4-40	CFEO, CFEOX	.040	1500	140	12	900	88	12
		CFE, CFEX	.060	1500	210	12	900	135	12
	#6-32	CFEO, CFEOX	.040	2100	185	20	1200	105	20
		CFE, CFEX	.060	2100	255	20	1300	175	20
	#8-32	CFEO, CFEOX	.040	2500	260	48	1500	155	48
		CFE, CFEX	.060	2500	360	48	1500	255	48
#10-32	CFEO, CFEOX	.040	2500	260	48	1500	155	48	
	CFE, CFEX	.060	2500	360	48	1500	255	48	
1/4-20 1/4-28	CFE, CFEX	.060	3500	420	110	2100	320	110	
Thread Size	Series	Sheet Thickness (mm.)	Cold-rolled Steel			5052-H34 Aluminum			
			Installation Force (kN)	Pushout (N)	Torque-out (N•m)	Installation Force (kN)	Pushout (N)	Torque-out (N•m)	
METRIC (mm)	M3	CFEO, CFEOX	1.0	6.7	622	1.35	4.0	391	1.35
		CFE, CFEX	1.5	6.7	934	1.35	4.0	590	1.3
	M4	CFEO, CFEOX	1.0	11.1	1156	5.42	6.7	689	5.42
		CFE, CFEX	1.5	11.1	1601	5.42	6.7	1134	5.42
	M5	CFEO, CFEOX	1.0	11.1	1156	5.42	6.7	689	5.42
		CFE, CFEX	1.5	11.1	1601	5.42	6.7	1134	5.42
M6	CFE, CFEX	1.5	15.6	1864	12.43	9.4	1423	12.43	

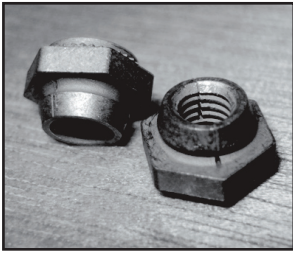

# Self-Clinching Self-Locking Nuts

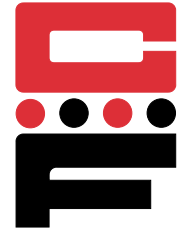

## Series CRT, CRTS & CRTA

CRT series fasteners provide a low-installed-cost solution where a clinching fastener with repeat locking torque is required. The design allows for greater reusability and minimizes the possibility of thread damage of the mating screw.

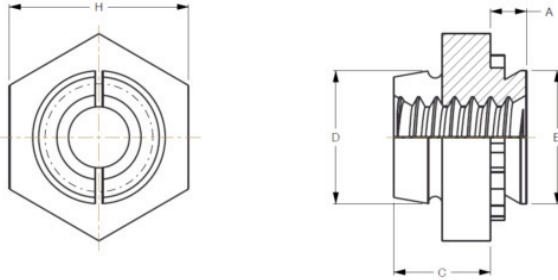

Series	Material	Finish
CRT	Carbon Steel	Black Dry film Lubricant over Zinc Phosphate
CRTS	300 Series Stainless Steel	Black Dry film Lubricant
CRTA	7075-T6 Aluminum	None

Thread: Internal 3B, ANSI B1.1 (6H ANSI/ASME B1.13M).

Use in: Cold-rolled Steel.

Part Number Structure:

CRTS 440-1ML



Note: Thread locking performance for CRT & CRTS is equivalent to applicable NASM25027 specifications.

### Dimensions & Specifications

INCH (in.)	Thread Size	Series			Shank Code	A Max.	Min.	+0.03 -0.00	B Max.	D Max.	C ±.010	H Nom.	Min.
		Carbon Steel	Stainless Steel	Aluminum†									
#440	CRT	CRTS	CRTA	-1	.038	.040	.187	.186	.185	.135	.250	.156	
	CRT	CRTS	CRTA	-2	.054	.056							
#6-32	CRT	CRTS	CRTA	-1	.038	.040	.219	.218	.220	.145	.312	.187	
	CRT	CRTS	CRTA	-2	.054	.056							
#8-32	CRT	CRTS	CRTA	-1	.038	.040	.266	.265	.250	.175	.343	.203	
	CRT	CRTS	CRTA	-2	.054	.056							
#10-32	CRT	CRTS	CRTA	-1	.038	.040	.312	.311	.285	.205	.375	.218	
	CRT	CRTS	CRTA	-2	.054	.056							

### Dimensions & Specifications

METRIC (mm)	Thread Size	Series			Shank Code	A Max.	Min.	+0.08 -0.00	B Max.	D Max.	C ±.010	H Nom.	Min.
		Carbon Steel	Stainless Steel	Aluminum†									
M3 x 0.5	CRT	CRTS	CRTA	-1	.97	1.0	4.75	4.73	4.85	3.43	6.35	4	
	CRT	CRTS	CRTA	-2	1.38	1.4							
M4 x 0.7	CRT	CRTS	CRTA	-1	.97	1.0	6.76	6.73	6.2	4.45	8.73	5.2	
	CRT	CRTS	CRTA	-2	1.38	1.4							
M5 x 0.8	CRT	CRTS	CRTA	-1	.97	1.0	7.92	7.9	7.4	5.21	9.53	5.6	
	CRT	CRTS	CRTA	-2	1.38	1.4							

†Not Stocked, available on special order.

\*Lubricated screw is required.

Continued on next page.

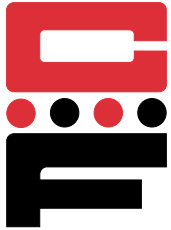

# Self-Clinching Self-Locking Nuts

## Series CRT, CRTS & CRTA

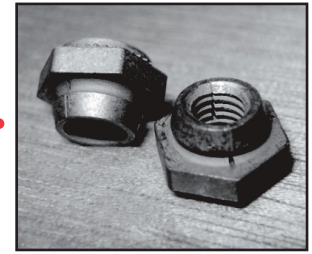

### Installation & Performance Data

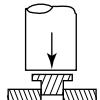
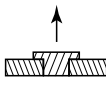
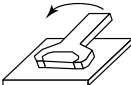
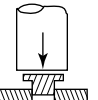
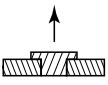
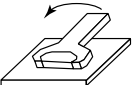
INCH (in.)	Thread Size	Shank Code	Cold-rolled Steel			5052-H34 Aluminum		
								
			Installation Force (lbs.)	Pushout (lbs.)	Torque-out (in.-lbs.)	Installation Force (lbs.)	Pushout (lbs.)	Torque-out (in.-lbs.)
#4-40	-1		3000	150	30	1600	130	25
	-2		3000	250	40	2000	200	35
#6-32	-1		4000	150	45	2400	130	25
	-2		4300	275	50	2700	225	45
#8-32	-1		4000	190	50	2700	150	45
	-2		4300	300	70	3000	250	50
#10-32	-1		4000	250	100	3200	150	90
	-2		4300	300	120	3200	250	105

### Installation & Performance Data

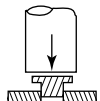
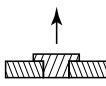
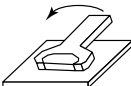
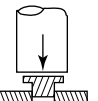
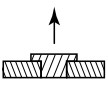
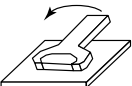
METRIC (mm)	Thread Size	Shank Code	Cold-rolled Steel			5052-H34 Aluminum		
								
			Installation Force (kN)	Pushout (N)	Torque-out (N•m)	Installation Force (kN)	Pushout (N)	Torque-out (N•m)
M3	-1		13.3	667	3.4	7.1	578	2.8
	-2		13.3	1112	4.5	8.9	667	4
M4	-1		17.8	845	5.6	12	667	5.1
	-2		19.1	1334	7.9	13.3	1112	5.7
M5	-1		17.8	1112	11.3	14.2	667	10.2
	-2		19.1	1334	13.6	14.2	1112	11.9

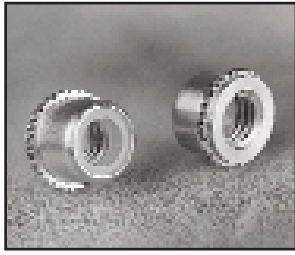

# Self-Clinching Top Collar Lock Nuts

## Series CPL & CPLC



CPL top collar lock nuts combine reliable self-clinching mounting with a reusable non-metallic thread locking element.

Series	Material	Finish	Locking Element
CPL	Heat-treated Carbon Steel	Zinc* Clear	Nylon
CPLC	300 Series Stainless Steel	Passivated ASTM A967	Nylon

\*See Finish Spec. on Page 6.

Thread: Internal 2B, ANSI B1.1 (6H, ANSI/ASME B1.13M).

Use in: Material with Rockwell Hardness of B-70 or less.

### Note 1. Installation Tips

**Thin Sheets:** May be installed in panel thickness of .040 to .059 in. (1mm to 1.5mm) if fastener is partially installed in sheet. The knurled collar must be raised above sheet by the difference in thickness from .059 in. (1.5mm).

**Thick Sheets:** If fastener is installed in sheet greater than .070 in. (1.7mm), knurled collar may crack if mating screw is tightened above maximum torque limit.

**Note 2.** Thread locking performance for CPL & CPLC is equivalent to applicable NASM25027 specifications.

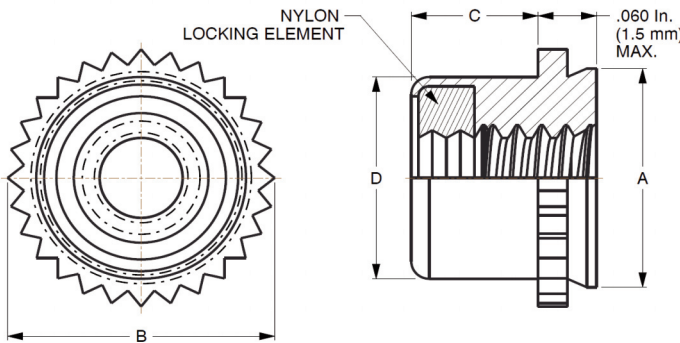

### Dimensions & Specifications

	Thread Size	Part Number		Thickness Range	See Note 1 	A Max.	B Max.	C Max.	D Max.	Min.
		Carbon Steel	Stainless Steel							
INCH (in.)	#4-40	CPL440	CPLC440	.040-.070	.234	.233	.274	.130	.215	.132
	#6-32	CPL632	CPLC632	.040-.070	.265	.264	.305	.130	.246	.158
	#8-32	CPL832	CPLC832	.040-.070	.297	.296	.338	.155	.278	.184
	#10-32	CPL1032	CPLC1032	.040-.070	.312	.311	.353	.165	.293	.210
METRIC (mm)	M3 x 0.5	CPLM3	CPLCM3	1-1.78	6.0	5.98	7.01	3.56	5.52	4.32
	M4 x 0.7	CPLM4	CPLCM4	1-1.78	7.5	7.48	8.54	4.2	7.01	5.59
	M5 x 0.8	CPLM5	CPLCM5	1-1.78	8.0	7.98	9.0	4.45	7.52	6.35

Continued on next page.





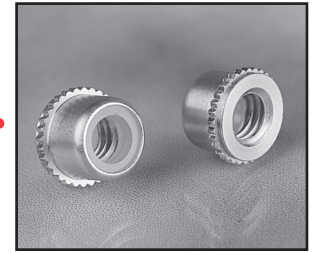

# Self-Clinching Top Collar Lock Nuts

## Series CPL & CPLC

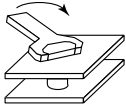
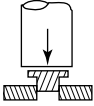

Continued from previous page.

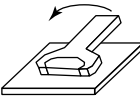
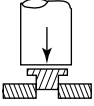
### Installation & Performance Data

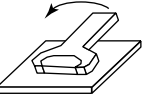
	.048 in. Cold-rolled Steel				.060 in. Cold-rolled Steel				
	 Max. Tightening Torque (in.-lbs.)	 Installation Force (lbs.)	 Pushout (lbs.)	 Torque-out (in.-lbs.)	 Installation Force (lbs.)	 Pushout (lbs.)	 Torque-out (in.-lbs.)		
Thread Size									
INCH (in.)	#4-40	9.3	3000	225	20	3000	260	20	
	#6-32	12.9	3000	270	30	3000	290	30	
	#8-32	19.1	3000	270	60	3000	290	60	
	#10-32	26	3000	310	70	3000	350	70	
		.060 in. 5052H34 Aluminum				.040 in. 5052H34 Aluminum			
	Thread Size	Max. Tightening Torque (in.-lbs.)	Installation Force (lbs.)	Pushout (lbs.)	Torque-out (in.-lbs.)	Installation Force (lbs.)	Pushout (lbs.)	Torque-out (in.-lbs.)	
	#4-40	9.3	2000	225	20	1500	160	20	
	#6-32	12.9	2000	285	30	1500	180	25	
	#8-32	19.1	2000	290	60	1500	180	28	
	#10-32	26	2000	300	70	1500	180	40	
		1.5mm Cold-rolled Steel				1.2mm Cold-rolled Steel			
	Thread Size	Max. Tightening Torque (N•m)	Installation Force (kN)	Pushout (N)	Torque-out (N•m)	Installation Force (kN)	Pushout (N)	Torque-out (N•m)	
	M3	1.13	13.34	1156	2.25	13.34	1000	2.25	
	M4	2.3	13.34	1290	6.77	13.34	1200	6.77	
	M5	3.12	13.34	1557	7.9	13.34	1380	7.9	
		1.5mm 5052H34 Aluminum				1.0mm 5052H34 Aluminum			
Thread Size	Max. Tightening Torque (N•m)	Installation Force (kN)	Pushout (N)	Torque-out (N•m)	Installation Force (kN)	Pushout (N)	Torque-out (N•m)		
M3	1.13	8.90	1000	2.25	6.67	710	2.25		
M4	2.3	8.90	1290	6.77	6.67	800	3.16		
M5	3.12	8.90	1330	7.9	6.67	800	4.51		



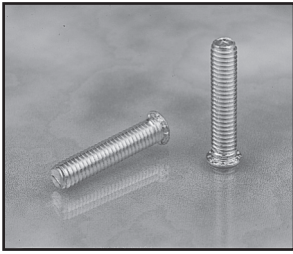

# Self-Clinching Studs Flush Head

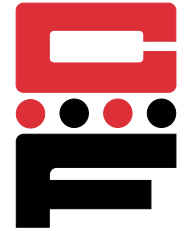

## Series CH, CHS & CHA

CH studs provide a strong flush-head assembly in material as thin as .040 in. (1.0 mm) with high torque-out and pushout performance.

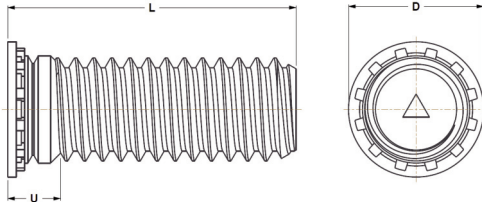

Part Number Structure:

CH 256-4



Series	Material	Finish
CH	Heat-treated Carbon Steel	Zinc* Clear
CHS	300 Series Stainless Steel	Passivated ASTM A967
CHA	2024-T4 Aluminum	None

\*See Finish Spec. on Page 6.

Thread: External 2A, ANSI B1.1 (6g ANSI/ASME B1.13M).\*\*

Use in: CH- Materials with HRB-80 or less.

CHS- Materials with HRB-70 or less.

CHA- Materials with HRB-50 or less.

\*\*See Note 3 on Page 6 for Gauging Spec.

### Dimensions & Specifications

INCH (in.)	Thread Size	Thread Code	L Length $\pm 0.015$ in.										D $\pm 0.015$	Max. Hole in Attached Part +0.003 -0.000	Min.	Min.	
			.250	.312	.375	.500	.625	.750	.875	1.00	1.25	1.50					
	#2-56	256	-4	-5	-6	-8	-10	-12 <sup>†</sup>					.144	.085	.105	.187	.040
	#4-40	440	-4	-5	-6	-8	-10	-12	-14	-16 <sup>†</sup>	-20		.176	.111	.135	.219	.040
	#6-32	632	-4	-5	-6	-8	-10	-12	-14	-16	-20	-24 <sup>†</sup>	.206	.137	.160	.250	.040
	#8-32	832	-4	-5	-6	-8	-10	-12	-14	-16	-20	-24 <sup>†</sup>	.237	.163	.185	.281	.040
	#10-24	1024		-5 <sup>†</sup>	-6	-8	-10	-12	-14	-16	-20	-24 <sup>†</sup>	.256	.189	.210	.281	.040
	#10-32	1032		-5 <sup>†</sup>	-6	-8	-10	-12	-14	-16	-20	-24	.256	.189	.210	.281	.040
	1/4-20	420			-6	-8	-10	-12	-14	-16	-20	-24	.337	.249	.270	.312	.062
	5/16-18	518				-8	-10	-12	-14	-16	-20	-24	.376	.311	.333	.375	.093

<sup>†</sup> Not stocked, available on special order.

<sup>††</sup> For aluminum studs, values are 60% of those listed.

### Dimensions & Specifications

METRIC (mm)	Thread Size	Thread Code	L Length $\pm 0.4$ mm												D $\pm 0.4$	Max. Hole in Attached Part +0.08 -0.00	Min.	Min.		
			6	8	10	12	15	18	20	22	25	28	30	35					38	
	M2.5x0.45	M2.5	-6 <sup>†</sup>	-8 <sup>†</sup>	-10 <sup>†</sup>	-12 <sup>†</sup>	-15 <sup>†</sup>	-18 <sup>†</sup>							4.1	2.5	3.1	5.4	1.0	
	M3x0.5	M3	-6 <sup>†</sup>	-8	-10	-12	-15	-18	-20	-22	-25				4.6	3.0	3.6	5.6	1.0	
	M3.5x0.6	M3.5	-6	-8	-10	-12	-15	-18	-20	-22	-25	-28	-30		5.3	3.5	4.1	6.4	1.0	
	M4x0.7	M4	-6 <sup>†</sup>	-8	-10	-12	-15	-18	-20	-22	-25	-28	-30	-35	-38	5.9	4.0	4.6	7.2	1.0
	M5x0.8	M5		-8 <sup>†</sup>	-10	-12	-15	-18	-20	-22	-25	-28	-30	-35	-38	6.5	5.0	5.6	7.2	1.0
	M6x1.0	M6			-10	-12	-15	-18	-20	-22	-25	-28	-30	-35	-38	8.2	6.0	6.6	7.9	1.6
	M8x1.25	M8				-12 <sup>†</sup>	-15	-18	-20	-22	-25	-28	-30	-35	-38	9.6	8.0	8.6	9.6	2.4

Note: Studs are available in lengths up to 3 in. (76.2 mm) upon special order for 1/4-20/M6 and larger.

Continued on next page.



# Self-Clinching Studs Flush Head

## Series CH, CHS & CHA

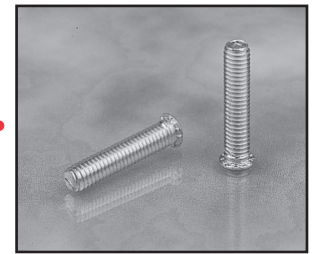

Continued from previous page.

### TOOLING

#### Note 1.

For material thickness of .059 in. or less, a countersunk hole is needed in the anvil.

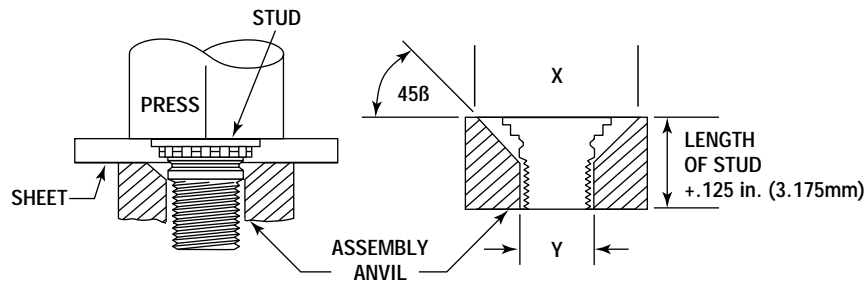

Tooling for sheet thickness .059 in. (1.51mm) and less with #2 (M2.5) thru #10 (M5) thread sizes and less than .093 in. (2.3mm) for 1/4 in. (M6) threads.

#### Note 2.

For material thickness of .060 in. or more, a through-hole is needed in the anvil.

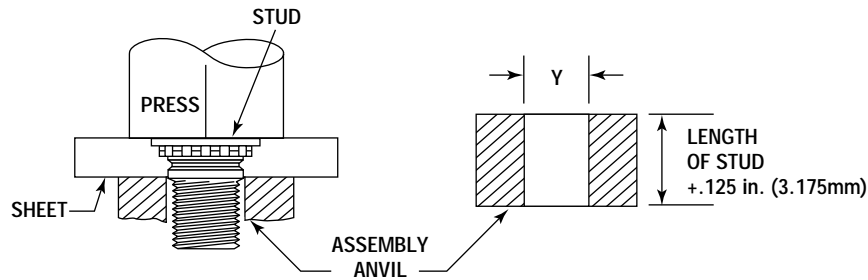

Tooling for sheet thickness .060 in. (1.51mm) minimum and greater with #2 (M2.5) thru #10 (M5) thread sizes and .092 in. (2.3mm) minimum and greater for 1/4 in. (M6) and 5/16 in. (M8) threads.

Thread Code	Anvil Dimensions (in.)	
	X +.004	Y +.003
256	.110	.087
	.114	.090
440	.136	.113
	.140	.116
632	.162	.139
	.166	.142
832	.188	.165
	.192	.168
1024	.216	.191
	.220	.194
1032	.216	.191
	.220	.194
420	.295	.250
	.300	.253
518	—	.3125
	—	.3155

Thread Code	Anvil Dimensions (mm)	
	X +.1	Y +.08
M2.5	3.1	2.50
M3	3.6	3.00
M3.5	4.1	3.50
M4	4.6	4.00
M5	5.6	5.00
M6	6.6	6.00
M8	—	8.00

Continued on next page.

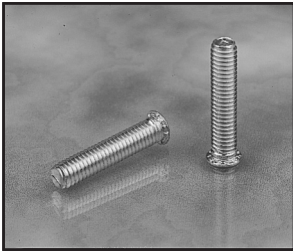



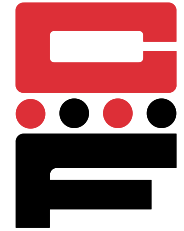

# Self-Clinching Studs Flush Head





## Series CH, CHS & CHA



Continued from previous page.

### Installation & Performance Data

Thread Code	SERIES	 Rec. Nut Tightening (in.-lbs)	 Sheet Thickness & Material	 Installation Force (lbs.)	 Pushout (lbs.)	 Torque out (in.-lbs.)	Pull Thru (lbs)	
UNIFIED	256	CH	4.4	.062 ALUM	2000	100	5	425
		CHS	2.7	.062 ALUM	2000	100	4.5	300
		CH	4.4	.060 STEEL	2500	180	5	425
		CHS	2.7	.060 STEEL	2500	180	4.5	300
	440	CH	8.7	.062 ALUM	3800	170	10	650
		CHS	5.9	.062 ALUM	3200	170	8	500
		CH	8.7	.060 STEEL	4300	275	10	650
		CHS	5.9	.060 STEEL	4700	275	8	500
	632	CH	14	.062 ALUM	3800	180	17	850
		CHS	11	.062 ALUM	3500	180	16	775
		CH	14	.060 STEEL	4700	300	20	850
		CHS	11	.060 STEEL	500	300	16	775
832	CH	20	.062 ALUM	4800	220	28	1000	
	CHS	16	.062 ALUM	4500	220	28	940	
	CH	25	.060 STEEL	6800	375	40	1270	
	CHS	19	.060 STEEL	5500	375	28	1130	
1024-1032	CH	28	.062 ALUM	5500	270	30	1220	
	CHS	24	.062 ALUM	5500	270	30	1220	
	CH	32	.060 STEEL	7500	450	60	1410	
	CHS	28	.060 STEEL	6800	450	50	1410	
420	CH	69	.093 ALUM	3500	310	65	2300	
	CHS	55	.093 ALUM	3500	310	65	2100	
	CH	77	.088 STEEL	9500	575	100	2550	
	CHS	67	.088 STEEL	10000	575	100	2550	
518	CH	85	.093 ALUM	6500	430	100	2280	
	CHS	74	.093 ALUM	6700	430	100	2280	
	CH	130	.093 STEEL	10000	650	175	3475	
	CHS	102	.093 STEEL	11200	650	175	3120	

Thread Code	SERIES	 Rec. Nut Tightening (N-m)	 Sheet Thickness & Material	 Installation Force (kN)	 Pushout (N)	 Torque out (N-m)	Pull Thru (N)
M2.5	CH	0.78	1.6 mm ALUM	8.9	465	1.0	2600
	CHS	0.48	1.6 mm ALUM	11.6	465	0.8	1820
	CH	0.84	1.5 mm STEEL	11.1	740	1.0	2800
	CHS	0.48	1.5 mm STEEL	13.8	740	0.8	1820
M3	CH	1.1	1.6 mm ALUM	12.9	600	1.7	3150
	CHS	0.81	1.6 mm ALUM	12.9	600	1.3	2570
	CH	1.4	1.5 mm STEEL	14.7	820	1.7	3840
	CHS	0.77	1.5 mm STEEL	14.7	820	1.3	2440
M3.5	CH	1.6	1.6 mm ALUM	15.6	800	1.7	3780
	CHS	1.3	1.6 mm ALUM	15.6	800	1.7	3445
	CH	1.6	1.5 mm STEEL	22.3	1335	2.8	0.78
	CHS	1.3	1.5 mm STEEL	22.3	1335	2.0	3445
M4	CH	2.1	1.6 mm ALUM	20	975	2.9	4448
	CHS	1.8	1.6 mm ALUM	22.3	975	2.9	4180
	CH	2.7	1.5 mm STEEL	28.9	1780	4.2	5650
	CHS	2	1.5 mm STEEL	26.7	1780	2.9	4775
M5	CH	3.1	1.6 mm ALUM	24.5	1070	3.5	5170
	CHS	2.5	1.6 mm ALUM	24.5	1070	3.5	4760
	CH	3.8	1.5 mm STEEL	33.4	2000	6.5	6270
	CHS	3.2	1.5 mm STEEL	32.5	2000	6.3	6000
M6	CH	7.3	2.4 mm ALUM	28.9	1660	7.3	10200
	CHS	5.7	2.4 mm ALUM	28.9	1660	7.3	9090
	CH	8.1	2.2 mm STEEL	44.5	2560	11.3	11300
	CHS	6.7	2.2 mm STEEL	44.5	2560	10.1	10600
M8	CH	10	2.4 mm ALUM	29.7	1910	11.3	10500
	CHS	8	2.4 mm ALUM	29.8	1910	11.3	9540
	CH	15	2.2 mm STEEL	44.5	2890	19.2	15450
	CHS	11	2.2 mm STEEL	49.8	2890	17.5	13630



# Self-Clinching Studs For Stainless Steel

## Series CHTS

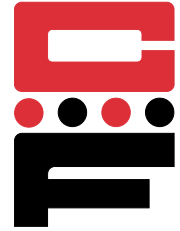

CHTS studs are made of heat treated stainless steel providing a strong, flush-head assembly in stainless steel material as thin as .040 in. (1 mm) with high torque-out and pushout performance.

Series	Material	Finish
CHTS	400 Series Stainless Steel	Passivated ASTM A967

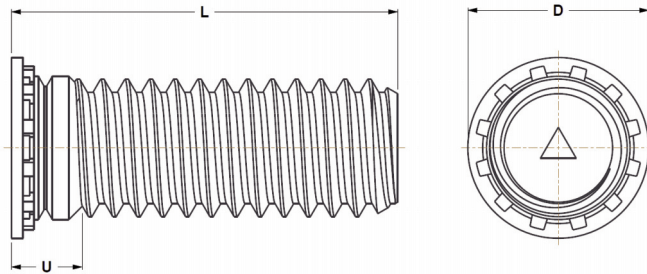

Thread: External 2A, ANSI B1.1 (6g ANSI/ASME B1.13M).  
Use in: CHTS - Materials with HRB-92 or less.

Part Number Structure:

CHTS 440-8

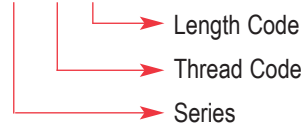

### Dimensions & Specifications

INCH (in.)	Thread Size	Series	Thread Code	L Length $\pm 0.015$ in.										Sheet Thickness	Hole Size In Sheet +.003 -.000	D $\pm 0.015$	U Max.	Min.
				.250	.312	.375	.500	.625	.750	.875	1.00	1.25	1.50					
#4-40	CHTS	440		-4	-5	-6	-8	-10	-12	-14	-16			.040-.095	.111	.176	.085	.219
#6-32	CHTS	632		-4	-5	-6	-8	-10	-12	-14	-16	-20	-24	.040-.095	.137	.206	.090	.250
#8-32	CHTS	832		-4	-5	-6	-8	-10	-12	-14	-16	-20	-24	.040-.095	.163	.237	.090	.281
#10-32	CHTS	1032			-5	-6	-8	-10	-12	-14	-16	-20	-24	.040-.095	.189	.256	.100	.281
1/4-20	CHTS	420				-6	-8	-10	-12	-14	-16	-20	-24	.062-.117	.249	.337	.135	.312
5/16-18	CHTS	518					-8	-10	-12	-14	-16	-20	-24	.093-.148	.311	.376	.160	.375

### Dimensions & Specifications

METRIC (mm.)	Thread Size	Series	Thread Code	L Length $\pm 0.4$ mm.										Sheet Thickness	Hole Size In Sheet +.08 -.00	D $\pm 0.4$	U Max.	Min.
				6	8	10	12	15	18	20	25	30	35					
M3 x 0.5	CHTS	M3		-6	-8	-10	-12	-15	-18	-20	-25			1 - 2.4	3	4.6	2.1	5.6
M4 x 0.7	CHTS	M4		-6	-8	-10	-12	-15	-18	-20	-25	-30	-35	1 - 2.4	4	5.9	2.4	7.2
M5 x 0.8	CHTS	M5			-8	-10	-12	-15	-18	-20	-25	-30	-35	1 - 2.4	5	6.5	2.7	7.2
M6 x 1.0	CHTS	M6				-10	-12	-15	-18	-20	-25	-30	-35	1.6 - 3	6	8.2	3.0	7.9
M8 x 1.25	CHTS	M8					-12	-15	-18	-20	-25	-30	-35	2.4 - 3.8	8	9.6	3.7	9.6

Note: All items subject to minimum order.

Continued on next page.



# Self-Clinching Studs For Stainless Steel

## Series CHTS



Continued from previous page.

### Installation Procedure

Drill or punch the proper size hole in the parent material and apply the recommended force, with a standard shop press, to fully seat the fastener. For best results, a flat punch with a minimum hardness of Rockwell C55 should be used along with a special anvil that has a raised ring. This will assure full displacement of the stainless steel material into the clinch ring of the stud.

Be sure to monitor the height of the ring on the anvil periodically and replace anvil when ring height wears down to .005 in. (.13 mm) to assure desired performance

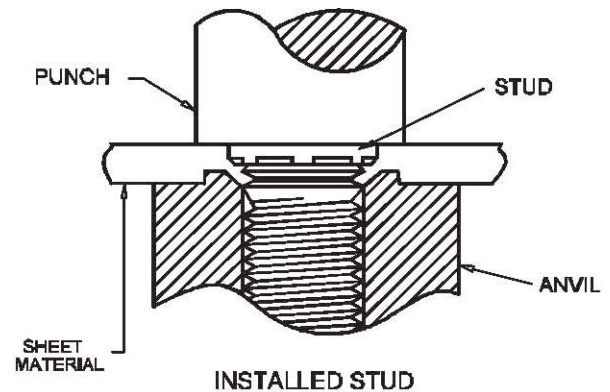

INCH (in.)	Thread Code	Anvil Dimensions (in.)					
		E	F	G	H	R1	R2
	440	.113	.144	.174	.010	.003	.005
	632	.140	.170	.200	.010	.003	.005
	832	.166	.202	.236	.010	.003	.005
	1032	.191	.235	.275	.010	.003	.005
	420	.251	.310	.363	.020	.003	.005
	518	.313	.385	.474	.020	.003	.005

METRIC (mm.)	Thread Code	Anvil Dimensions (mm.)					
		E	F	G	H	R1	R2
	M3	3.05	3.81	4.57	.25	.08	.13
	M4	4.04	4.95	5.82	.25	.08	.13
	M5	5.08	6.15	7.16	.25	.08	.13
	M6	6.05	7.87	8.79	.51	.08	.13
	M8	7.95	9.78	10.27	.51	.08	.13

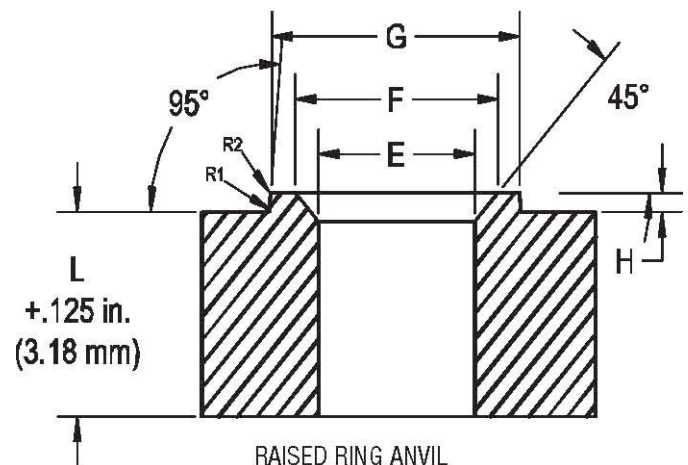







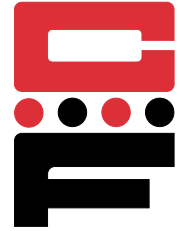

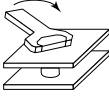
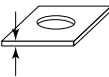

# Self-Clinching Studs For Stainless Steel

## Series CHTS

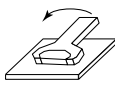
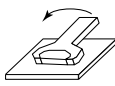

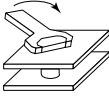
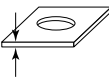
Continued from previous page.

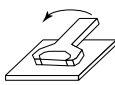
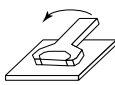
### Installation & Performance Data

INCH (in.)								
	Thread Code	Max. Nut Tight. Torque (in.-lbs.)	Sheet Thickness & Material	Sheet Hardness HRB Max.	Installation (lbs.)	Pushout (lbs.)	Torque-out (in.-lbs.)	Pull thru (lbs.)
	440	6	.060 SS	87	9000	450	16	800
	632	11	.060 SS	87	9500	540	27	1350
	832	21	.060 SS	86	11200	780	58	1800
	1032	33	.060 SS	86	12000	800	95	2250
	420	70	.060 SS	88	13000	1600	156	3900
	518	80	.090 SS	92	16000	1775	295	7375
METRIC (mm)								
	Thread Code	Max. Nut Tight. Torque (N•m)	Sheet Thickness & Material	Sheet Hardness HRB Max.	Installation (kN)	Pushout (N)	Torque-out (N•m)	Pull thru (N)
	M3	.9	1.5mm SS	87	40	2200	1.8	3500
	M4	2.1	1.5mm SS	86	50	3210	6.5	8000
	M5	4.3	1.5mm SS	86	53	3560	10.7	10000
	M6	7.2	1.5mm SS	88	58	4200	15.9	14900
M8	9.0	2.3mm SS	92	71	7895	33.3	32804	

# Self-Clinching Studs for Stainless Steel with Superior Corrosion Resistance

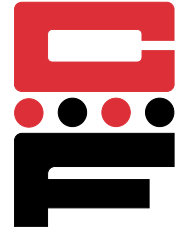

## Series CH2S

CH2S studs are made of heat treated stainless steel providing a strong, flush-head assembly in stainless steel material as thin as .040 in. (1 mm) with high torque-out and pushout performance. They provide excellent corrosion resistance and are recommended for use in marine, food service, medical applications. They also can be used in applications up to 1200° F.

Series	Material	Finish
CH2S	A286 Stainless Steel	Passivated ASTM A967

Thread: External 2A, ANSI B1.1 (6g ANSI/ASME B1.13M)  
Use in: Materials with HRB-92 or less.

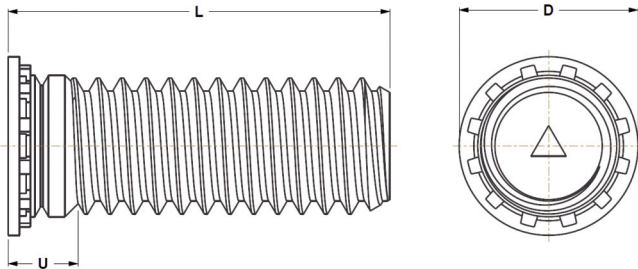

Part Number Structure:

CH2S-440-10



### Dimensions & Specifications

INCH (in.)	Thread Size	Thread Code	L Length $\pm .015$ in.										Thickness Range	+003 .000	D $\pm .015$	U Max	Min
			.250	.312	.375	.500	.625	.750	.875	1.00	1.25	1.50					
	#4-40	440	-4	-5	-6	-8	-10	-12	-14	-16			.040-.095	.111	.176	.085	.219
	#6-32	632	-4	-5	-6	-8	-10	-12	-14	-16	-20	-24	.040-.095	.137	.206	.090	.250
	#8-32	832	-4	-5	-6	-8	-10	-12	-14	-16	-20	-24	.040-.095	.163	.237	.090	.281
	#10-32	1032		-5	-6	-8	-10	-12	-14	-16	-20	-24	.040-.095	.189	.256	.100	.281

### Dimensions & Specifications

METRIC (mm)	Thread Size	Thread Code	L Length $\pm .4$ mm										Thickness Range	+08 .00 -	D $\pm .4$	U Max	Min
			6	8	10	12	15	18	20	25	30	35					
	M3x0.5	M3	-6	-8	-10	12	-15	-18	-20	-25			1 - 2.4	3	4.6	2.1	5.6
	M4x0.7	M4	-6	-8	-10	12	-15	-18	-20	-25	-30	-35	1 - 2.4	4	5.9	2.4	7.2
	M5x0.8	M5		-8	-10	12	-15	-18	-20	-25	-30	-35	1 - 2.4	5	6.5	2.7	7.2

Note: All items subject to minimum order.







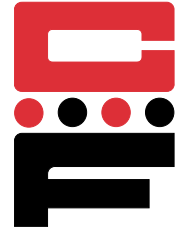

# Self-Clinching Studs for Stainless Steel with Superior Corrosion Resistance



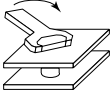
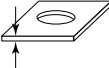

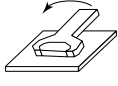

## Series CH2S

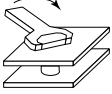
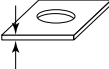

Continued from previous page.

### Installation & Performance Data

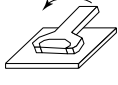
INCH (in.)								
	Thread Code	Max. Nut Tight. Torque (in.-lbs.)	Sheet Thickness & Material	Sheet Hardness HRB Max.	Installation (lbs.)	Pushout (lbs.)	Torque-out (in.-lbs.)	Pull thru (lbs.)
	440	8.1	.045 SS	86	9000	520	10.6	605
	632	16	.045 SS	86	9500	670	19.5	940
	832	28	.045 SS	86	11200	785	37.5	1415
	1032	34	.045 SS	86	12000	800	59.5	1500

METRIC (mm)								
	Thread Code	Max. Nut Tight. Torque (N•m)	Sheet Thickness & Material	Sheet Hardness HRB Max.	Installation (kN)	Pushout (N)	Torque-out (N•m)	Pull thru (N)
	M3	1.3	1.14mm SS	86	40	2500	1.6	3500
	M4	2.9	1.14mm SS	86	50	3000	3.9	6000
	M5	4.4	1.14mm SS	86	53	3560	7.35	7320



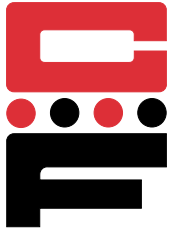

# Self-Clinching Studs High Torque

## Series HCH, HCHS & HCHB (High-Torque)

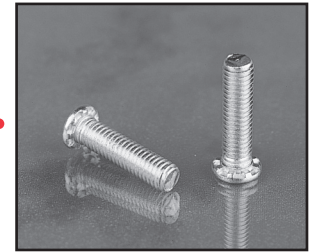

HCH high-torque studs offer advantages over weld studs and other fasteners. The heavy head configuration provides greater torque-out and improved pull-through resistance.

Phosphor Bronze studs provide excellent electrical conductivity and mechanical attachment in copper. The head of the stud will remain above the surface when properly installed.

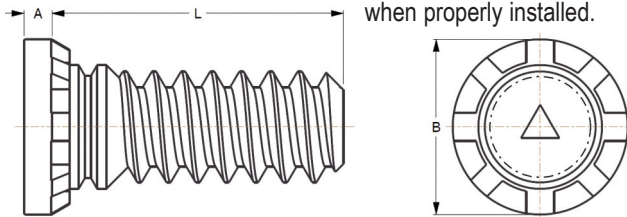

HCH 1024-8  
 Part Number Structure:  
 → Length Code  
 → Thread Code  
 → Series

Series	Material	Finish
HCH	Heat-treated Medium Carbon Steel	Zinc* Clear
HCHS	300 Series Stainless Steel	Passivated ASTM A967
HCHB	Phosphor Bronze CDA-510	None

\*See Finish Spec. on Page 6.

Thread: External 2A, ANSI B1.1 (6g ANSI/ASME B1.13M).\*\*

Use in: Cold-rolled Steel or 5052-H34 Aluminum with Rockwell Hardness as follows:

HCH- Materials with HRB-85 or less.

HCHS- Materials with HRB-70 or less.

HCHB- Materials with HRB-55 or less.

\*\*See Note 3 on Page 6 for Gauging Spec.

### Dimensions & Specifications

INCH (in.)	Thread Size	Thread Code	L Length $\pm 0.015$ in.						Min.	+005 -000	Max. Hole in Attach. Parts	A Max.	B $\pm 0.01$	Min.
			.500	.750	1.00	1.25	1.50	1.75						
#10-24	1024	-8	-12	-16	-20	-24	-28	.050	.190	.252	.040	.300	.415	
#10-32	1032	-8	-12	-16	-20	-24	-28†	.050	.190	.252	.040	.300	.415	
1/4-20	420	-8	-12	-16	-20	-24	-28†	.060	.250	.312	.050	.380	.460	
5/16-18	518	-8†	-12	-16	-20	-24	-28†	.075	.312	.374	.070	.480	.500	
3/8-16	616	-12	-16	-20	-24	-28†	.090	.375	.437	.085	.580	.530		

Thread Strength: HCH = 120 ksi / HCHS = 75 ksi / HCHB = 60 ksi.

† Not stocked, available on special order.

### Dimensions & Specifications

METRIC (mm)	Thread Size	Thread Code	L Length $\pm 0.4$ mm						Min.	+013 -00	Max. Hole in Attach. Parts	A Max.	B $\pm 0.25$	Min.
			20	25	30	35	40	50						
M5x0.8	M5	-20	-25	-30	-35	-40	-50	1.3	5.0	6.4	1.14	7.8	10.7	
M6x1.0	M6	-20	-25	-30	-35	-40	-50	1.5	6.0	7.5	1.27	9.4	11.5	
M8x1.25	M8	-20	-25	-30	-35	-40	-50	2.0	8.0	9.5	1.78	12.5	12.7	
M10x1.5	M10	-20	-25	-30	-35	-40	-50	2.3	10.0	11.5	2.29	15.7	13.7	

Thread Strength: HCH = 900 MPa / HCHS = 515 MPa / HCHB = 415 MPa.

Note: Studs are available in lengths up to 3 in. (76.2 mm) upon special order for 1/4-20/M6 and larger.

Continued on next page.

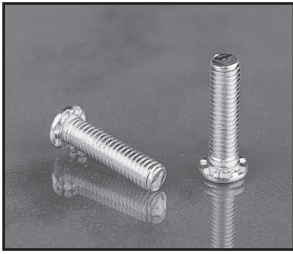

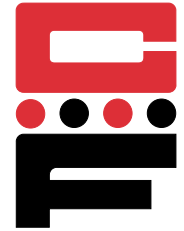

# Self-Clinching Studs High Torque

## Series HCH, HCHS & HCHB (High-Torque)

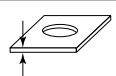

Continued from previous page.

### Installation & Performance Data

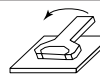
	Thread Code	Series	 Sheet Thickness & Material	Sheet Hardness HRB	 Installation Force (lbs.)	 Pushout (lbs.)	 Torque-out (ft.-lbs.)	Max. Nut Tightening Torque (ft.-lbs.)
INCH (in.)	1024 1032	HCH	.060 Aluminum	15	3000	180	4	4.6
		HCH	.060 Steel	65	6000	375	5	4.6
		HCHS	.050 Aluminum	38	3000	180	4	2.5
		HCHS	.058 Aluminum	52	4500	325	4	2.5
		HCHB	.061 Copper CDA-110	28	3400	150	2.9	1.7
	420	HCH	.060 Aluminum	43	5500	285	11	9.6
		HCH	.060 Steel	59	7000	480	11	9.6
		HCHS	.064 Aluminum	32	4000	285	8	5.2
		HCHS	.072 Aluminum	43	6500	480	8	5.2
		HCHB	.061 Copper CDA-110	28	6000	380	5	3.6
	518	HCH	.091 Aluminum	39	8000	380	22	20
		HCH	.090 Steel	58	10000	590	22	20
		HCHS	.087 Aluminum	41	5500	380	15	11
		HCHS	.099 Steel	44	7500	590	15	11
		HCHB	.126 Copper CDA-110	32	7500	500	11	7
	616	HCH	.091 Aluminum	39	12000	550	25	35
		HCH	.090 Steel	58	16000	780	36	35
		HCHS	.123 Aluminum	44	10000	560	25	19
		HCHS	.099 Steel	44	13000	780	25	19
		HCHB	.126 Copper CDA-110	32	12000	560	18	13
	Thread Code	Series	Sheet Thickness & Material	Sheet Hardness HRB	Installation Force (kN)	Pushout (N)	Torque-out (N • m)	Max. Nut Tightening Torque (N • m)
METRIC (mm)	M5	HCH	1.5 Aluminum	15	13	800	5.4	7.7
		HCH	1.5 Steel	65	26	1500	7.6	7.7
		HCHS	1.62 Aluminum	35	12.4	800	5.4	3.8
		HCHS	1.47 Aluminum	54	21.7	1500	6.4	3.8
		HCHB	1.5 Copper CDA-110	28	15.6	1115	3.4	2.7
	M6	HCH	1.5 Aluminum	43	29	1270	14	13
		HCH	1.5 Steel	59	33	1750	14	13
		HCHS	1.62 Aluminum	35	15.4	1270	11	6.5
		HCHS	1.6 Aluminum	45	24.6	1750	11	6.5
		HCHB	1.5 Copper CDA-110	28	25.3	1600	6.7	4.5
	M8	HCH	2.3 Aluminum	39	35.6	1700	30	32
		HCH	2.3 Steel	58	44.5	2200	30	32
		HCHS	2.23 Aluminum	44	24.4	1700	20	16
		HCHS	2.48 Steel	43	37.8	2100	20	16
		HCHB	3.2 Copper CDA-110	32	33	2250	15.3	11
	M10	HCH	2.3 Aluminum	39	53.3	2445	36	63
		HCH	2.3 Steel	58	91.2	3470	49	63
		HCHS	2.3 Aluminum	44	44.4	2445	36	31
		HCHS	2.3 Steel	44	57.7	3470	36	31
		HCHB	3.2 Copper CDA-110	32	53.3	2500	25	22



# Self-Clinching Studs High Torque (Wide Head)



## Series HCW (Wide-Head)

HCW Wide-Head studs offer advantages over weld studs and other fasteners. The wide head configuration provides strong load bearing threads in materials as thin as .040 in. (1mm).

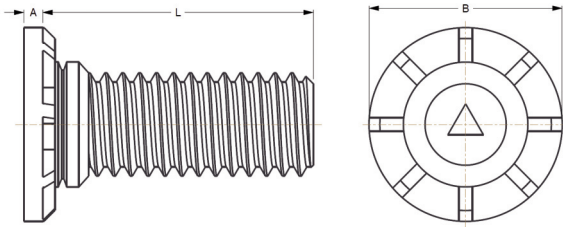

Series	Material	Finish
HCW	Heat-treated Medium Carbon Steel	Zinc* Clear

\*See Finish Spec. on Page 6.

Thread: External 2A, ANSI B1.1 (6g ANSI/ASME B1.13M)\*\*

Use in: Cold-rolled Steel or 5052-H34 Aluminum  
with Rockwell Hardness of HRB-85 or less:

Part Number Structure:

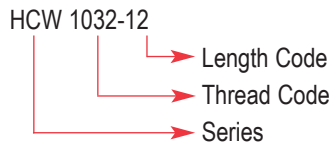

\*\*See Note 3 on Page 6 for Gauging Spec.

### Dimensions & Specifications

	Thread Size	Thread Code	L Length $\pm 0.015$ in.							Min. Sheet Thickness	+0.005 -0.000	A Max.	B $\pm 0.01$	Max Hole in Attached Parts	Min.
			.500	.750	1.00	1.25	1.50	1.75	2.00						
INCH (in.)	#10-32	1032	-8 <sup>†</sup>	-12	-16	-20	-24 <sup>†</sup>	-28 <sup>†</sup>	-32 <sup>†</sup>	.040	.190	.048	.357	.280	.360
	1/4-20	420	-8 <sup>†</sup>	-12	-16	-20	-24 <sup>†</sup>	-28 <sup>†</sup>	-32 <sup>†</sup>	.040	.250	.060	.462	.340	.470
	5/16-18	518	-8 <sup>†</sup>	-12	-16	-20	-24	-28 <sup>†</sup>	-32 <sup>†</sup>	.060	.312	.083	.586	.402	.560

Thread Strength= 120 ksi.

### Dimensions & Specifications

	Thread Size	Thread Code	L Length $\pm 0.4$ mm							Min. Sheet Thickness	+0.13 -0.00	A Max.	B $\pm 0.25$	Max Hole in Attached Parts	Min.
			15	20	25	30	35	40	50						
METRIC (mm)	M5 x 08	M5	-15 <sup>†</sup>	-20	-25 <sup>†</sup>	-30	-35 <sup>†</sup>	-40 <sup>†</sup>	-50 <sup>†</sup>	1	5	1.35	9.6	7.3	10
	M6 x 1.0	M6	-15 <sup>†</sup>	-20	-25 <sup>†</sup>	-30	-35 <sup>†</sup>	-40 <sup>†</sup>	-50 <sup>†</sup>	1	6	1.52	11.35	8.3	11.5
	M8 x 1.25	M8	-15 <sup>†</sup>	-20	-25 <sup>†</sup>	-30	-35 <sup>†</sup>	-40 <sup>†</sup>	-50 <sup>†</sup>	1.5	8	2.13	15.3	10.3	14.5

Thread Strength= 900 MPa.

<sup>†</sup> Not stocked, available on special order.

Continued on next page.





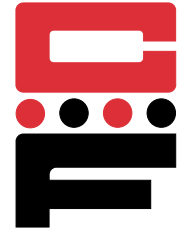



# Self-Clinching Studs High Torque (Wide Head)

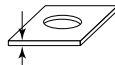

## Series HCW (Wide-Head)

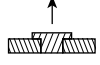
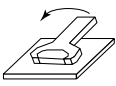
Continued from previous page.

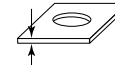
### Installation & Performance Data

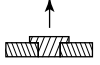
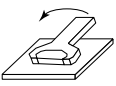
INCH (in.)						
	Thread Code	Sheet Thickness & Material	Sheet Hardness HRB	Installation Force (lbs.)	Pushout (lbs.)	Torque-out (in.-lbs.)
	1032	.040 Aluminum	27	7500	170	60
		.040 Cold Rolled Steel	67	9500	300	60
	420	.040 Aluminum	27	8000	180	120
		.040 Cold Rolled Steel	67	13500	340	130
	518	.060 Aluminum	22	9000	275	240
		.060 Cold Rolled Steel	65	15500	575	290
METRIC (mm)						
	Thread Code	Sheet Thickness & Material	Sheet Hardness HRB	Installation Force (kN)	Pushout (N)	Torque-out (N•m)
	M5	1 mm Aluminum	27	37.7	690	8.1
		1 mm Cold Rolled Steel	67	51.1	1350	8.1
	M6	1 mm Aluminum	27	39	750	11.8
		1 mm Cold Rolled Steel	67	60	1400	14.4
M8	1.5 mm Aluminum	22	42	1230	23.5	
	1.5 mm Cold Rolled Steel	65	71.1	2400	33.9	

### CAPTIVE® Dog-Point Studs

CAPTIVE studs are available with a dog-point end to assist the attachment of mating nuts, which is especially useful in high-speed production assembly, using motorized nut drivers. Dog-points may be specified on most CH, TCH, HCH, CHTS, and HCW style studs as a special order, using the following Part Number Structure:

Example: HCW 1032-8 DP

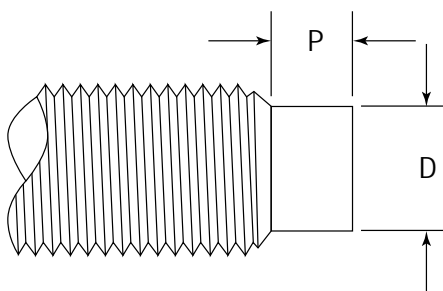
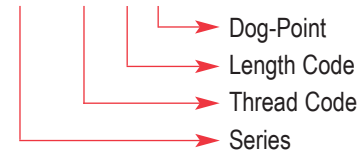

INCH (in.)	D ±.005	P ±.010	METRIC (mm)		
			D ±.13	P ±.25	
6-32	.086	.050	M3.5 x 0.6	2.4	1.27
8-32	.111	.055	M4 x 0.7	2.79	1.4
10-24	.124	.065	M5 x 0.8	3.66	1.78
10-32	.138	.065	M6 x 1	4.37	2.03
1/4 x 20	.173	.085	M8 x 1.25	6.05	2.67
1/4 x 28	.192	.085			
5/16 x 18	.228	.105			

Note: Maximum dog-point diameter is .003 in. (.08 mm) less than the minimum minor diameter of 2B or 6g mating nut threads.

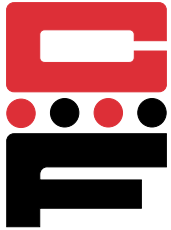

# Self-Clinching Studs Thin Sheets

## Series TCH & TCHS Non-Flush Studs



TCH non-flush studs are manufactured for use in sheets as thin as .020 inches (.5 mm) thick. The pushout and torque-out values are excellent for most applications. The head of the stud will project above the panel surface when installed properly. Do not over squeeze!

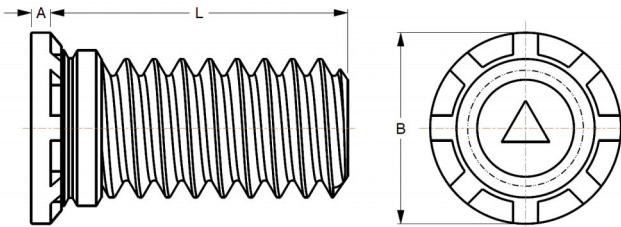

TCH 440-4  
 Part Number Structure:  
 → Length Code  
 → Thread Code  
 → Series

Series	Material	Finish
TCH	Heat-treated Carbon Steel	Zinc* Clear
TCHS	300 Series Stainless Steel	Passivated ASTM A967

\*See Finish Spec. on Page 6.

Thread: External 2A, ANSI B1.1 (6g ANSI/ASME B1.13M).\*\*

Use in: Cold-rolled Steel or 5052-H34 Aluminum with Rockwell Hardness as follows:

TCH - Materials with HRB 80 or less.

TCHS - Materials with HRB 70 or less.

\*\*See Note 3 on Page 6 for Gauging Spec.

### Dimensions & Specifications

INCH (in.)	Thread Size	Thread Code	L Length $\pm .015$ in.											Min.	+003 -000	A Max.	B $\pm .015$	Min.
			.250	.312	.375	.500	.625	.750	.875	1.00	1.25	1.50						
	#4-40	440	-4	-5	-6	-8	-10	-12					.020	.111	.025	.176	.219	
	#6-32	632	-4	-5	-6	-8	-10	-12	-14	-16	-20	-24 <sup>†</sup>	.020	.137	.025	.203	.250	
	#8-32	832	-4	-5	-6	-8	-10	-12	-14	-16	-20	-24 <sup>†</sup>	.020	.163	.025	.234	.281	
	#10-24	1024		-5 <sup>†</sup>	-6	-8	-10	-12	-14	-16	-20	-24 <sup>†</sup>	.020	.189	.025	.250	.281	
	#10-32	1032		-5 <sup>†</sup>	-6	-8	-10	-12	-14	-16	-20	-24 <sup>†</sup>	.020	.189	.025	.250	.281	

<sup>†</sup>Not stocked, available on special order.

### Dimensions & Specifications

METRIC (mm)	Thread Size	Thread Code	L Length $\pm .4$ mm												Min.	+08 -00	A Max.	B $\pm .4$	Min.	
			6	8	10	12	15	18	20	22	25	28	30	35						38
	M3 x 0.5	M3	-6	-8	-10	-12	-15	-18	-20		-25				.51	3.0	.64	4.5	5.6	
	M4 x 0.7	M4			-10	-12	-15	-18	-20	-22	-25	-28	-30	-35	-38	.51	4.0	.64	5.8	7.2
	M5 x 0.8	M5			-10	-12	-15	-18	-20	-22	-25	-28	-30	-35	-38	.51	5.0	.64	6.4	7.2

Continued on next page.

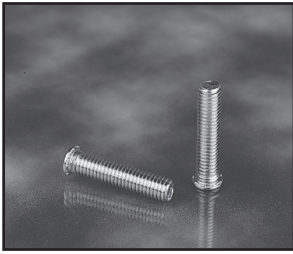

# Self-Clinching Studs Thin Sheets

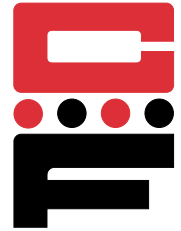



## Series TCH & TCHS Non-Flush Studs

Continued from previous page.

Note: Values based on stainless steel studs (steel stud values may be higher).

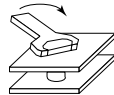
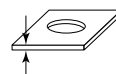
### Installation & Performance Data

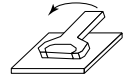
INCH (in.)								
	Thread Code	Max. Nut Tight. Torque (in.-lbs.)	Sheet Thickness & Material	Sheet Hardness HRB	Installation Force (lbs.)	Pushout (lbs.)	Torque-out (in.-lbs.)	
INCH (in.)	440	5	.020 Aluminum	28	1200	45	7	
			.025 Steel	52	1500	100	8	
	632	9	.020 Aluminum	28	1500	50	8	
			.025 Steel	52	2500	110	16	
	832	17	.020 Aluminum	28	2200	60	11	
			.025 Steel	52	2700	120	26	
	1024	24	.020 Aluminum	28	2500	65	14	
	1032	27	.025 Steel	52	3000	130	28	
	METRIC (mm)	M3	.74	.5 Aluminum	28	5.3	195	6
				.6 Steel	52	6.7	300	1
M4		1.70	.5 Aluminum	28	9.8	250	.7	
			.6 Steel	52	13.4	500	2.5	
M5		3.50	.5 Aluminum	28	13.4	270	1.3	
			.6 Steel	52	17.8	670	3	



# Self-Clinching Studs Close Edge

## Series CHE & CHES



CHE studs allow installation closer to material edge than standard studs without distortion of sheet edge. Provides flush-head assembly in material thickness of .040 in. (1 mm) or more.

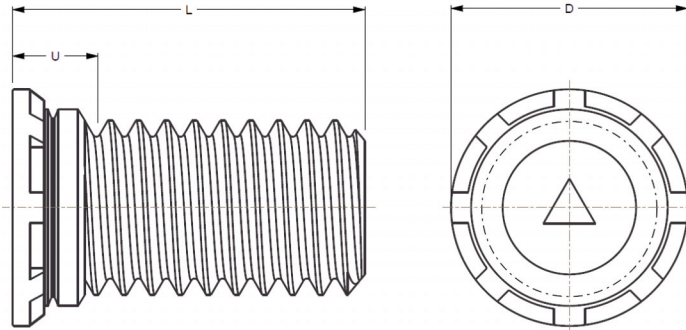

Series	Material	Finish
CHE	Heat-treated Carbon Steel	Zinc* Clear
CHES	300 Series Stainless Steel	Passivated ASTM A967

\* See Finish Spec. on Page 6

Thread: External 2A, ANSI B1.1 (6g ANSI/ASME B1.13M)\*\*

Use in: CHE - Material with HRB=80 or less.

CHES - Material with HRB=70 or less.

Part Number Structure:

CHE 256 - 4



\*\*See Note 3 on Page 6 for Gauging Spec.

### Dimensions & Specifications

Note: Min Sheet Thickness .040 in.

INCH (in.)	Thread Size	Series		Thread Code	L Length $\pm 0.015$ in.										+0.003 -0.000	D $\pm 0.015$	U Max	Min
		Steel	SS		.250	.312	.375	.500	.625	.750	.875	1.00	1.25	1.50				
	#2-56	CHE	CHES	256	-4	-5	-6	-8	-10	-12					.085	.122	.080	.098
	#4-40	CHE	CHES	440	-4	-5	-6	-8	-10	-12	-14	-16			.111	.138	.085	.124
	#6-32	CHE	CHES	632	-4	-5	-6	-8	-10	-12	-14	-16	-20	-24	.137	.164	.090	.150
	#8-32	CHE	CHES	832	-4	-5	-6	-8	-10	-12	-14	-16	-20	-24	.163	.190	.090	.176
	#10-32	CHE	CHES	1032	-4	-5	-6	-8	-10	-12	-14	-16	-20	-24	.189	.225	.100	.210

### Dimensions & Specifications

Note: Min Sheet Thickness 1 mm

METRIC (mm)	Thread Size	Series		Thread Code	L Length $\pm 0.4$ mm										+0.08 -0.00	D $\pm 0.4$	U Max	Min
		Steel	SS		6	8	10	12	15	18	20	25	30	35				
	M2.5 X 0.45	CHE	CHES	M2.5	-6	-8	-10	-12	-15	-18					2.5	3.15	2.1	2.8
	M3 X 0.5	CHE	CHES	M3	-6	-8	-10	-12	-15	-18	-20				3	3.65	2.1	3.3
	M3.5 X 0.6	CHE	CHES	M3.5	-6	-8	-10	-12	-15	-18	-20	-25	-30		3.5	4.15	2.3	3.8
	M4 X 0.7	CHE	CHES	M4	-6	-8	-10	-12	-15	-18	-20	-25	-30	-35	4	4.65	2.4	4.3
	M5 X 0.8	CHE	CHES	M5	-6	-8	-10	-12	-15	-18	-20	-25	-30	-35	5	5.9	2.7	5.6

Continued on next page.



# Self-Clinching Studs Close Edge

## Series CHE & CHES



Continued from previous page.

### Installation Procedure

- 1) Prepare the correct size hole in the base material by punching or drilling. Do not deburr hole.
- 2) Place the stud through the base material and insert into the support anvil.
- 3) Apply sufficient squeezing force with a shop press until the head of the fastener is flush with the sheet material.

Tooling for panel thickness  
.059 in. (1.5 mm) and less

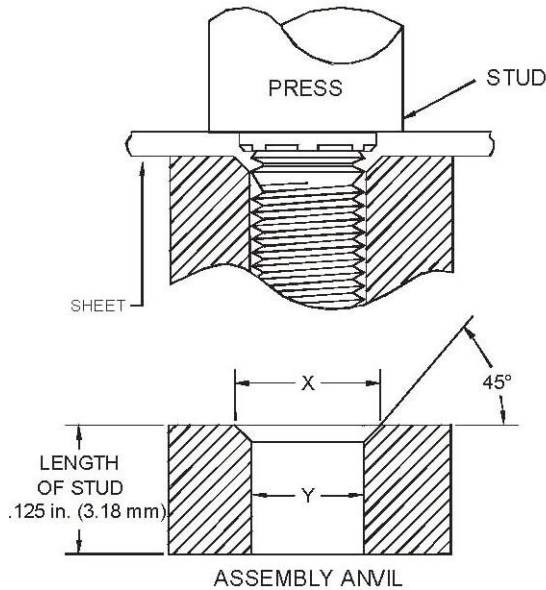

Tooling for panel thickness  
.060 in. (1.51 mm) and greater

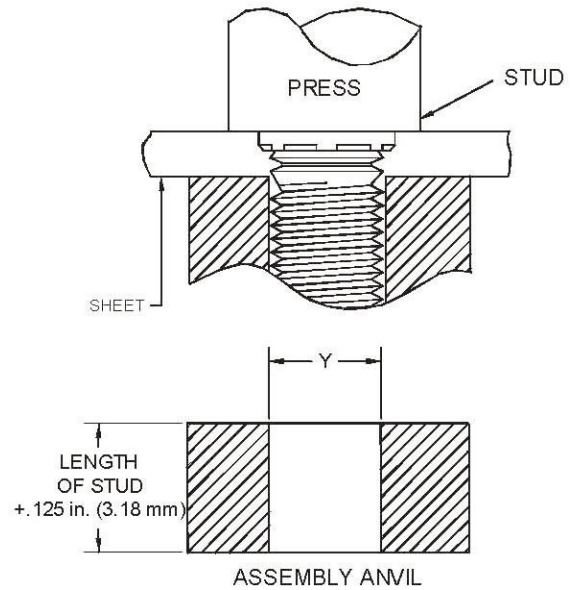

INCH (in.)	SERIES	Anvil Dimensions (in)	
		X + .004	Y + .003
	256	.110	.087
	440	.136	.113
	632	.163	.139
	832	.188	.165
	1032	.216	.191

METRIC (mm)	SERIES	Anvil Dimensions (mm)	
		X + .01	Y + .08
	M2.5	3.1	2.53
	M3	3.6	3.03
	M3.5	4.1	3.53
	M4	4.6	5.03
	M5	5.6	5.03

Continued on next page.











# Self-Clinching Studs Close Edge

## Series CHE & CHES

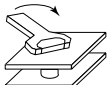
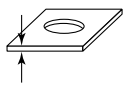

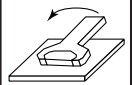
Continued from previous page.

### Installation & Performance Data

INCH (in.)									
	Thread Code	Max. Nut Tightening Torque (in. lbs.)	Sheet Thickness And Material	Sheet Hardness HRB	Installation Force (lbs.)	Pushout (lbs.)	Torque Out (in.-lbs.)	Pull Thru (lbs.)	Test Bushing Hole Size
256		2.3	.047 Aluminum	33	700	55	4	230	.106
		2.3	.045 Cold Rolled Steel	54	1200	85	8	425	.106
440		4.0	.047 Aluminum	33	1000	60	5	300	.132
		5.0	.045 Cold Rolled Steel	54	1200	105	11	580	.132
632		5.4	.047 Aluminum	33	1000	65	6.5	325	.158
		9.0	.045 Cold Rolled Steel	54	1500	110	15	650	.158
832		6.9	.047 Aluminum	33	1200	80	9	350	.184
		15.2	.045 Cold Rolled Steel	54	1500	125	18	740	.184
1032		9.7	.047 Aluminum	33	2500	115	18	395	.210
		19.4	.045 Cold Rolled Steel	54	4500	210	38	800	.210

METRIC (mm)	Thread Code	Max. Nut Tightening Torque (N.m.)	Sheet Thickness And Material	Sheet Hardness HRB	Installation Force (kN)	Pushout (N)	Torque Out (N*m)	Pull Thru (N)	Test Bushing Hole Size
	M2.5		.41	1.2mm Aluminum	33	3.1	285	.55	1200
		.41	1.1mm Cold Rolled Steel	54	5.3	450	1.1	2250	3
M3		.46	1.2mm Aluminum	33	4.4	285	.65	1300	3.5
		.74	1.1mm Cold Rolled Steel	54	5.3	475	1.25	2500	3.5
M3.5		.58	1.2mm Aluminum	33	4.4	290	.76	1400	4
		1.15	1.1mm Cold Rolled Steel	54	6.6	500	1.75	2800	4
M4		.75	1.2mm Aluminum	33	5.3	365	1.1	1550	4.5
		1.7	1.1mm Cold Rolled Steel	54	6.6	550	2.1	3300	4.5
M5		1.11	1.2mm Aluminum	33	11.1	530	2.2	1850	5.5
		2.25	1.1mm Cold Rolled Steel	54	20	1000	4.4	3750	5.5



# Self-Clinching Studs Concealed-Head Series CFA & CFC



CFA & CFC concealed-head studs allow permanent mounting in thin metal sheets, using a hollow punch and solid anvil. The stud head is pressed permanently into a blind milled hole, with no marring of the exterior surface.

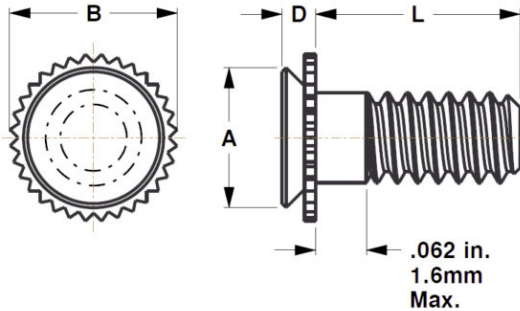

Series	Material	Finish
CFA	2024-T4 Aluminum	None
CFC	300 Series Stainless Steel	Passivated ASTM A967

Thread: External 2A, ANSI B1.1 (6g ANSI/ASME B1.13M).\*

Use in: CFA - HRB-50 or less.  
CFC - HRB-70 or less.

Part Number Structure:

CFA-1-440-4



\*See Note 3 on Page 6 for Gauging Spec.

## Dimensions & Specifications

INCH (in.)	Thread Size	Material		Thread Code	L Length ±.015 (Length Code is in 16ths of an inch)						Min.	Blind Mounting Hole Dia. +.003 -.000	Min. Depth Of Blind Hole	D Max.	B ±.010	A Max.	Min.	Max. Hole in Attached Parts
		Aluminum	Stainless Steel		.250	.375	.500	.625	.750	1.00								
		CFA-1	CFC-1		CFA-2	CFC-2												
#4-40	CFA-1	CFC-1	440	-4	-6	-8	-10	-12		.062	.172	.043	.041	.205	.171	.156	.135	
																		CFA-2
	#6-32	CFA-1	CFC-1	632	-4	-6	-8	-10	-12	-16	.062	.213	.043	.041	.250	.212	.188	.160
#8-32	CFA-1	CFC-1	832	-4	-6	-8	-10	-12	-16	.062	.290	.043	.041	.328	.289	.219	.185	
																		CFA-2
#10-32	CFA-1	CFC-1	1032		-6	-8	-10	-12	-16	.062	.312	.043	.041	.350	.311	.250	.210	
																		CFA-2

## Dimensions & Specifications

METRIC (mm)	Thread Size	Material		Thread Code	L Length ±.4 (Length Code is in mm)							Min.	Blind Mounting Hole Dia. +.08 -.00	Min. Depth Of Blind Hole	D Max.	B ±.25	A Max.	Min.	Max. Hole in Attached Parts
		Aluminum	Stainless Steel		6	8	10	12	16	20	25								
		CFA-1	CFC-1		CFA-2	CFC-2													
M3x0.5	CFA-1	CFC-1	M3	-6	-8	-10	-12	-16	-20		1.6	4.37	1.1	1.04	5.21	4.35	4	3.6	
																			CFA-2
M4x0.7	CFA-1	CFC-1	M4	-6	-8	-10	-12	-16	-20	-25	1.6	7.37	1.1	1.04	8.33	7.35	5.6	4.6	
																			CFA-2
M5x0.8	CFA-1	CFC-1	M5			-10	-12	-16	-20	-25	1.6	7.93	1.1	1.04	8.89	7.9	6.4	5.6	
																			CFA-2

\*Not stocked, available on special order.

Continued on next page.



# Self-Clinching Studs Concealed-Head Series CFA & CFC



Continued from previous page.

## Installation & Performance Data

	Type	Thread Code	Tightening Torque Max. (in.-lbs.)	Sheet Material			
				Cold-rolled Steel		5052-H34 Aluminum	
				Installation Force (lbs.)	Pullout (lbs.)	Installation Force (lbs.)	Pullout (lbs.)
INCH (in.)	CFC-1	440	4.75	4000	300	2800	200
		632	8.75	4500	350	3000	240
		832	18	4800	400	4000	270
		1032	32	5500	450	5000	290
	CFC-2	440	4.75	4300	350	2900	220
		632	8.75	5000	360	3200	240
		832	18	5300	440	4000	300
		1032	32	6000	600	5000	430
	CFA-1	440	2.85	N/A	N/A	1400	130
		632	5.4	N/A	N/A	1800	160
		832	10.8	N/A	N/A	2800	180
		1032	19.2	N/A	N/A	4000	210
	CFA-2	440	2.85	N/A	N/A	1500	200
		632	5.4	N/A	N/A	2500	260
		832	10.8	N/A	N/A	3000	310
		1032	19.2	N/A	N/A	3500	300

	Type	Thread Code	Max. (N•m)	Cold-rolled Steel		5052-H34 Aluminum	
				(kN)	(N)	(kN)	(N)
METRIC (mm)	CFC-1	M3	.5	8	1065	6.2	575
		M4	2	17.8	1200	12.5	800
		M5	3.6	22.2	1290	17.8	930
	CFC-2	M3	.5	8.9	1065	6.7	890
		M4	2	14.7	1955	13.3	1375
		M5	3.6	17.8	3020	15.6	1600
	CFA-1	M3	.3	N/A	N/A	6.2	555
		M4	1.2	N/A	N/A	12.5	645
		M5	2.16	N/A	N/A	17.8	755
	CFA-2	M3	.3	N/A	N/A	6.7	845
		M4	1.2	N/A	N/A	13.3	1065
		M5	2.16	N/A	N/A	15.6	1330



# Self-Clinching Studs Concealed-Head Series CFA & CFC Typical Installation Method

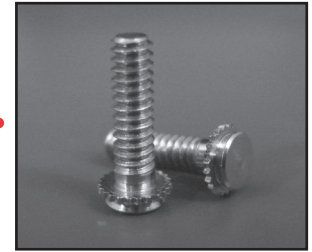

Continued from previous page.

## Installation Procedure

1. Mill a blind hole in material to specified depth.\*
2. Place fastener into hole in anvil.
3. Place sheet material over head of fastener.
4. Apply a downward squeezing force with punch, pressing on sheet material until serrated collar of fastener is flush with surface.

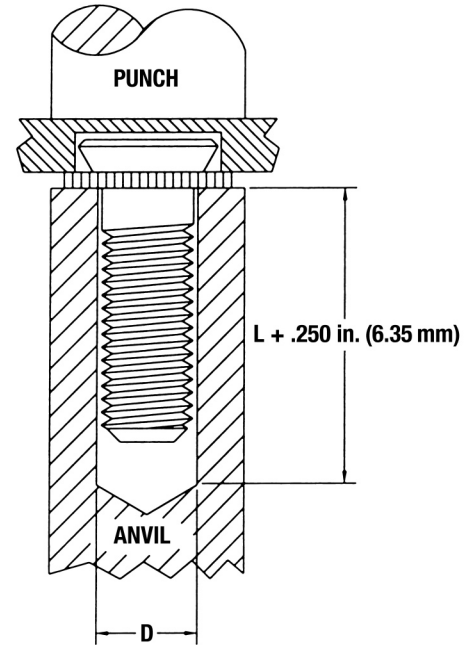

\*Depth of blind holes may be greater than minimum, if sheet thickness allows.

### Anvil 'D' Diameter Dimensions for Concealed Head Studs

INCH (in.)	Series	Thread Code	D Dia. (in.)
	CFA CFC		440
		632	.152
		832	.179
		1032	.205

METRIC (mm)	Series	Thread Code	D Dia. (mm)
	CFA CFC		M3
		M4	4.4
		M5	5.4

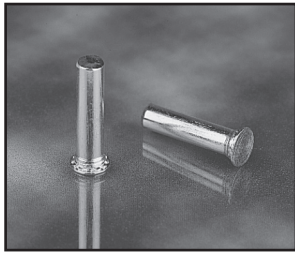

# Self-Clinching Pins

## Series CH, CHN, CHS & CHA

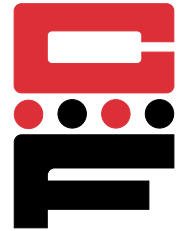

CH pins provide a strong flush-head assembly in material as thin as .040 inches (1 mm) with high pushout performance.

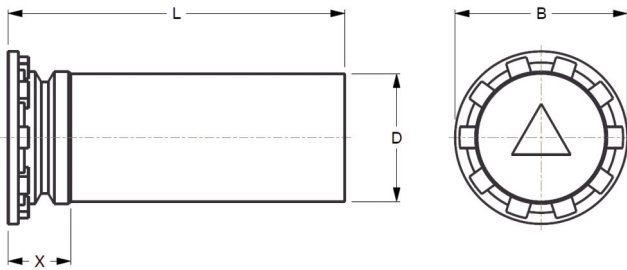

Part Number Structure:

CH 073-4

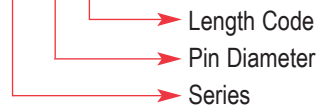

Series	Material	Finish
CH	Carbon Steel, Heat-treated	Zinc* Clear
CHN	Carbon Steel, Non-Heat-treated	Zinc* Clear
CHS	300 Series Stainless Steel	Passivated ASTM A967
CHA	2024-T4 Aluminum	None

\*See Finish Spec. on Page 6.

- Use in:
- CH – Materials with HRB-80 or less.
  - CHN – Materials with HRB-50 or less.
  - CHS – Materials with HRB-70 or less.
  - CHA – Materials with HRB-50 or less.

### Dimensions & Specifications

D Pin Dia. ±.002	L Length ±.015 in.										B ±.015	X Max.	Min.	+.003 -.000	Min.
	.250	.312	.375	.500	.625	.750	.875	1.00	1.25	1.50					
.073	-4	-5	-6	-8	-10						.15	.075	.040	.085	.19
.084	-4	-5	-6	-8	-10	-12					.16	.085	.040	.099	.22
.094	-4	-5	-6	-8	-10	-12					.18	.085	.040	.111	.22
.103	-4	-5	-6	-8	-10	-12					.18	.085	.040	.118	.22
.106	-4	-5	-6	-8	-10	-12	-14	-16	-20		.19	.090	.040	.125	.22
.116	-4	-5	-6	-8	-10	-12	-14	-16	-20		.21	.090	.040	.137	.25
.120	-4	-5	-6	-8	-10	-12	-14	-16	-20		.21	.090	.040	.137	.25
.137	-4	-5	-6	-8	-10	-12	-14	-16	-20	-24	.23	.090	.040	.157	.28
.141	-4	-5	-6	-8	-10	-12	-14	-16	-20	-24	.24	.090	.040	.163	.28
.160		-5	-6	-8	-10	-12	-14	-16	-20	-24	.26	.100	.040	.189	.28
.167		-5	-6	-8	-10	-12	-14	-16	-20	-24	.26	.100	.040	.189	.28
.173		-5	-6	-8	-10	-12	-14	-16	-20	-24	.26	.100	.040	.197	.28
.207			-6	-8	-10	-12	-14	-16	-20	-24	.32	.135	.062	.236	.31
.215				-8	-10	-12	-14	-16	-20	-24	.34	.135	.062	.250	.31
.223				-8	-10	-12	-14	-16			.34	.135	.062	.250	.31
.273				-8	-10	-12	-14	-16	-20	-24	.38	.160	.093	.312	.38
.281				-8	-10	-12	-14	-16			.38	.160	.093	.312	.38

Note: 1. Pins are available in lengths up to 3 in. (76.2 mm) upon special order.  
2. Tapered-point pins are available upon request, subject to minimum order quantity.

Continued on next page.



# Self-Clinching Pins

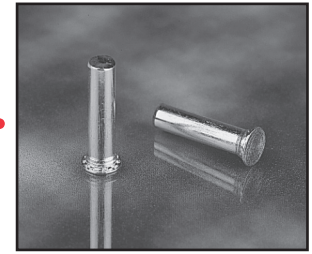

## Series CH, CHN, CHS & CHA

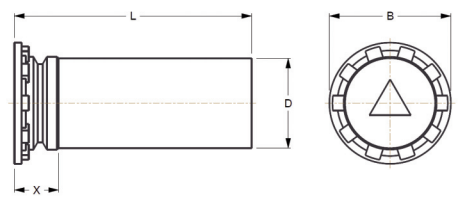

Continued from previous page.

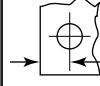

### Dimensions & Specifications

METRIC (mm)	D Pin Dia. ±.05	L Length ±.4mm										B ±.4	X Max.	 Min.	 + .08 - .00	 Min.
		6	8	10	12	15	18	20	25	30	35					
	3mm	-6	-8	-10	-12	-15	-18	-20	-25	-30	N/A	5.3	2.3	1.0	3.5	6.4
	4mm	N/A	-8	-10	-12	-15	-18	-20	-25	-30	-35	6.0	2.3	1.0	4.1	7.1
	5mm	N/A	-8	-10	-12	-15	-18	-20	-25	-30	-35	7.5	2.55	1.0	5.5	7.6



# Self-Clinching Tapered Guide Pins

## Series CGS (Tapered Guide Pins)

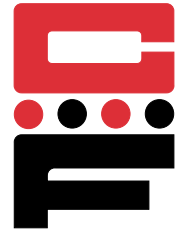

CGS Tapered Guide Pins provide a strong flush-head assembly in materials as thin as .040 in. (1mm) with high pushout resistance. A tapered end allows ease of locating mating hole in a variety of alignment and pivot applications.

Series	Material	Finish
CGS	300 Series Stainless Steel	Passivated ASTM A967

Use in: Materials with Rockwell Hardness of B-70 or less.

Part Number Structure:

CGS-125-8

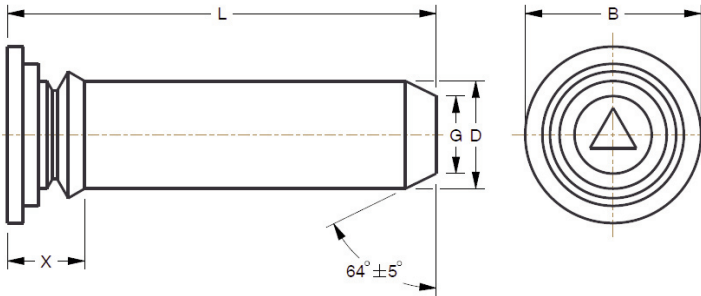
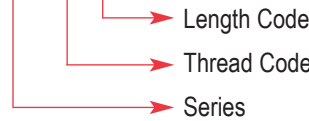

### Dimensions & Specifications

INCH (in.)	Pin Dia. D ±.002	L Length ±.015 in.					B ±.015	X Max.	G ±.006	Min.	+ .003 - .000	Min.
		.375	.500	.625	.750	1.00						
.125		-6	-8	-10	-12		.205	.090	.090	.040	.144	.250
.187		-6	-8	-10	-12	-16	.270	.090	.132	.040	.205	.280
.250			-8	-10	-12	-16	.335	.090	.177	.040	.272	.310

METRIC (mm)	Pin Dia. D ±.05	L Length ±.4mm					B ±.4	X Max.	G ±.15	Min.	+ .08 - .00	Min.
		8	10	12	16	20						
3mm		-8	-10	-12	-16		5.2	2.29	2.05	1	3.5	6.4
4mm		-8	-10	-12	-16		6.12	2.29	2.82	1	4.5	7.1
5mm			-10	-12	-16	-20	7.19	2.29	3.53	1	5.5	7.6
6mm				-12	-16	-20	8.13	2.29	4.24	1	6.5	7.9

### Installation & Performance Data

INCH (in.)	Pin Dia. D ±.002	Test Material	Sheet Hardness HRB	Installation (lbs.)	Pushout (lbs.)
.125		Aluminum	20	4500	150
		Steel	62	6500	250
.187		Aluminum	18	6500	230
		Steel	60	8000	400
.250		Aluminum	18	7000	270
		Steel	62	9000	500

METRIC (mm)	Pin Dia. D ±.05	Test Material	Sheet Hardness HRB	Installation (kN)	Pushout (kN)
3mm		Aluminum	22	12	.56
		Steel	65	22	.98
4mm		Aluminum	19	22	.89
		Steel	66	26.4	1.54
5mm		Aluminum	18	28.6	1.01
		Steel	60	35.2	1.76
6mm		Aluminum	18	30.8	1.1
		Steel	62	39.6	2.1

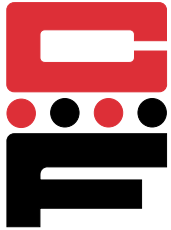

# Broaching Type Nuts

## Series CKF2 & CKFS2



CKF2 and CKFS2 broaching-type fasteners are designed for use on printed circuit boards and on most brittle or hard materials; such as, glass laminates, epoxy or resin with paper, nylon, or canvas bases. They are also used on materials too thin or unsuitable for threading, such as acrylic and polycarbonate panels.

Since the aforementioned materials do not flow under pressure, these fasteners are designed with a knurled shank that can be pressed into a drilled hole. The shank grips the board with an interference fit by broaching its way into the panel as it is squeezed into the holes.

Series	Material	Finish
CKF2	Carbon Steel	Electro tin plating (Zinc* optional)
CKFS2	300 Series Stainless Steel	Passivated ASTM A967

\*See Finish Spec. on Page 6.

Thread: Internal 2B, ANSI B1.1 (6H, ANSI/ASME B1.13M).

Use in: Materials with Rockwell Hardness of B-60 or less.

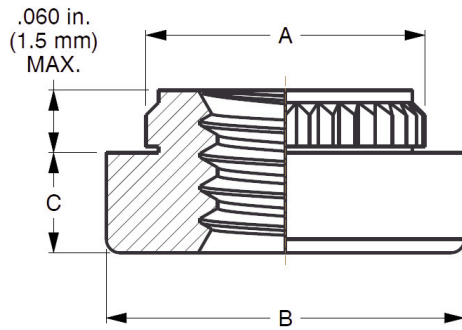

### Dimensions & Specifications

Thread Size	Part Number		A ±.003	B ±.005	C ±.005	+ .003 - .000	Min.	Min.	
	Carbon Steel	Stainless Steel							
INCH (in.)	#2-56	CKF2256	CKFS2256	.165	.219	.065	.147	.16	.060
	#4-40	CKF2440	CKFS2440	.184	.219	.065	.166	.17	.060
	#6-32	CKF2632	CKFS2632	.231	.281	.065	.213	.22	.060
	#8-32	CKF2832	CKFS2832	.268	.344	.096	.250	.25	.060
	#10-24	CKF21024	CKFS21024	.290	.375	.127	.272	.28	.060
	#10-32	CKF21032	CKFS21032	.290	.375	.127	.272	.28	.060
METRIC (mm)	M2 x 0.4	CKF2M2	CKFS2M2	4.19	5.56	1.5	3.73	4.2	1.53
	M2.5 x 0.45	CKF2M2.5	CKFS2M2.5	4.68	5.56	1.5	4.22	4.4	1.53
	M3 x 0.5	CKF2M3	CKFS2M3	4.68	5.56	1.5	4.22	4.4	1.53
	M4 x 0.7	CKF2M4	CKFS2M4	6.81	8.74	2.0	6.4	6.4	1.53
	M5 x 0.8	CKF2M5	CKFS2M5	7.37	9.53	3.0	6.9	7.1	1.53

Note: CKF2 & CKFS2 broaching fasteners are designed for unplated through-holes. When installed in plated through-holes, a hole tolerance of +.005 - .001 in. (+.13 - .03 mm) should be used.

When used in plated through-holes, performance will be reduced and plating may be damaged by knurl.

Continued on next page.



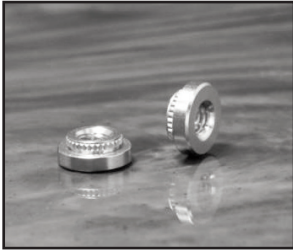

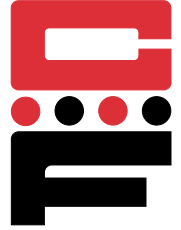

# Broaching Type Nuts

## Series CKF2 & CKFS2



Continued from previous page.

### Installation & Performance Data

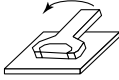
Fiberglass .060 in. (1.5 mm)				
				
	Thread Size	Installation Force (lbs.)	Pushout (lbs.)	Torque-out (in.-lbs.)
INCH (in.)	#2-56	400	60	6
	#4-40	400	65	15
	#6-32	500	80	30
	#8-32	700	95	35
	#10-24	700	100	40
	#10-32	700	100	40
	Thread Size	Installation Force (kN)	Pushout (N)	Torque-out (N•m)
METRIC (mm)	M2	2.22	265	.65
	M2.5	2.22	285	1.35
	M3	2.22	285	1.70
	M4	2.90	415	3.95
	M5	2.90	435	4.52



# Broaching Type Standoffs

## Series CKFE & CKFSE

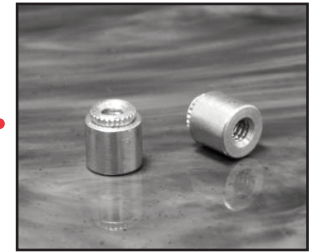

CKFE and CKFSE threaded and non-threaded standoffs allow screws to be inserted through multiple layered boards for stacked assemblies. All fasteners from Captive Fastener are identical to industry standards so that they can be fed through standard automatic insertion equipment.

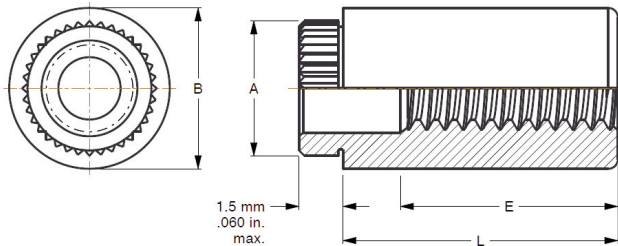

† Not stocked, available on special order.

Note: Min Panel Thickness .060 in. (1.5mm)

Series	Material	Finish
CKFE	Carbon Steel	Electro Tin Plating ASTM B545 Class B (Zinc* Clear Optional)
CKFSE	300 Series Stainless Steel	Passivated ASTM A967

\*See Finish Spec. on Page 6.

Thread: Internal 2B, ANSI B1.1 (6H, ANSI/ASME B1.13M).

Use in: CKFE - Materials with Rockwell Hardness of B-60 or less.

CKFSE - Materials with Rockwell Hardness of B-70 or less.

Part Number Structure:

CKFE 440-4

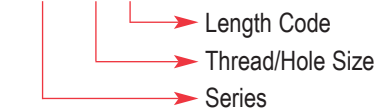

Note: CKFE & CKFSE broaching standoffs are designed for unplated through-holes. When installed in plated through-holes, a hole tolerance of  $+.005$  -  $-.001$  in. ( $+.13$  -  $-.03$  mm) should be used. When used in plated through-holes performance will be reduced and plating may be damaged by knurl.

### Dimensions & Specifications

Thread Size	Thru Hole + .004 - .003	Part Number		L Length $\pm .005$ in.								A	B	+ .003 - .000	Min.
		Carbon Steel	Stainless Steel	.125	.250	.375	.500	.625	.750	.875	$\pm .003$	$\pm .005$			
				Full								$.375 \pm .015$			
INCH (in.)	#4-40	CKFE440	CKFSE440	-4	-8	-12	-16	-20	-24 <sup>†</sup>			.184	.219	.166	.17
	#6-32	CKFE632	CKFSE632	-4	-8	-12	-16	-20	-24 <sup>†</sup>	-28 <sup>†</sup>		.231	.281	.213	.22
	.116	CKFE116	CKFSE116	-4	-8	-12	-16	-20	-24 <sup>†</sup>			.184	.219	.166	.17
	.143	CKFE143	CKFSE143	-4	-8	-12	-16	-20	-24 <sup>†</sup>	-28 <sup>†</sup>		.231	.281	.213	.22
E=minimum thread length				Full								$.375 \pm .015$			
Thread Size	+ .10 - .08	Part Number		Length $\pm .13$ mm								A	B	+ .08 - .00	Min.
		Carbon Steel	Stainless Steel	3	4	6	8	10	12	14	16	$\pm .08$	$\pm .13$		
				Full								$9.5 \pm .4$			
				Full								$9.5 \pm .4$			
METRIC (mm)	M3x0.5	CKFEM3	CKFSEM3	-3	-4	-6	-8	-10	-12	-14	-16 <sup>†</sup>	4.68	5.56	4.22	4.4
	3.6	CKFE3.6	CKFSE3.6	-3	-4	-6 <sup>†</sup>	-8 <sup>†</sup>	-10 <sup>†</sup>	-12 <sup>†</sup>	-14 <sup>†</sup>	-16 <sup>†</sup>	5.87	7.14	5.41	5.5
	4.2	CKFE4.2	CKFSE4.2	-3 <sup>†</sup>	-4 <sup>†</sup>	-6 <sup>†</sup>	-8 <sup>†</sup>	-10 <sup>†</sup>	-12 <sup>†</sup>	-14 <sup>†</sup>	-16 <sup>†</sup>	6.86	8.74	6.4	7.1
E=minimum thread length (where applicable)				Full								$9.5 \pm .4$			

### Installation & Performance Data

Thread Size	Fiberglass .060 in. (1.5 mm)		
	Installation Force (lbs.)	Pushout (lbs.)	Torque-out (in.-lbs.)
INCH (in.)			
#4-40	400	65	15
#6-32	500	80	30
METRIC (mm)			
Thread Size	Installation Force (kN)	Pushout (N)	Torque-out (N•m)
M3	2.2	290	1.7

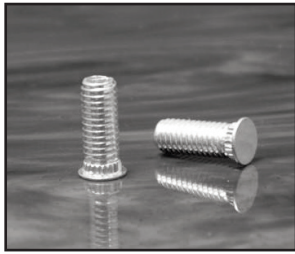

# Broaching Type Studs

## Series CKFH

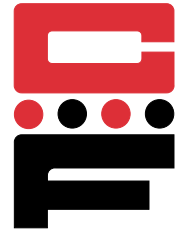

CKFH broaching-type studs are electroplated with tin so they are readily solderable. Thus, they can be used both as solderable connectors and as permanently mounted mechanical fasteners.

Part Number Structure:  
CKFH 440-4

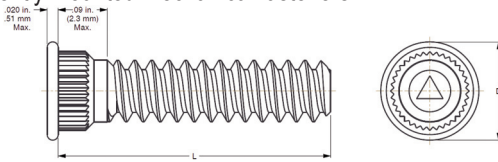

- Length Code
- Thread Code
- Series

Series	Material	Finish
CKFH	Phosphor Bronze CDA-510	Electro Tin Plating ASTM B545 Class B (Zinc* Optional)

\*See Finish Spec. on Page 6.

Thread: External 2A, ANSI B1.1 (6g ANSI/ASME B1.13M).\*\*

Use in: Materials with Rockwell Hardness of B-55 or less.

\*\*See Note 3 on Page 6 for Gauging Spec.

### Dimensions & Specifications

INCH (in.)	Thread Size	Part Number	L Length ±.010 in.						D ±.010	Max. Size Clear. Hole in Attach. Parts	Max. Nut Tight. Torque (in.-lbs.)	Anvil Hole +.003 Min. -.000 Min.			
			.250	.312	.375	.500	.625	.750							
			Length ±.010 in.												
	#4-40	CKFH440	-4	-5	-6	-8	-10	-12	.18	.120	.145	4	.15	.113	.060
	#6-32	CKFH632	-4	-5	-6	-8	-10	-12	.20	.140	.170	8	.19	.140	.060
	#8-32	CKFH832		-5	-6	-8	-10	-12	.225	.166	.195	15	.20	.166	.060
	#10-32	CKFH1032			-6	-8	-10	-12	.25	.189	.220	18	.20	.191	.060

METRIC (mm)	Thread Size	Part Number	L Length ±.25 mm						D ±.25	Max. Size Clear. Hole in Attach. Parts	Max. Nut Tight. Torque	Anvil Hole +.08 Min. -.00 Min.			
			6	8	10	12	15	18							
			Length ±.25 mm												
	M3x0.5	CKFHM3	-6	-8	-10	-12	-15	-18	4.58	3	3.7	.45	3.8	3.1	1.53
	M4x0.7	CKFHM4	-6	-8	-10	-12	-15	-18	5.74	4.2	4.8	1.60	5.1	4.1	1.53
	M5x0.8	CKFHM5	-6	-8	-10	-12	-15	-18	6.60	5	5.8	2.10	5.3	5.1	1.53

### Installation & Performance Data

Thread Size	Fiberglass .060 in. (1.5 mm)		
	Installation Force (lbs.)	Pushout (lbs.)	Torque-out (in.-lbs.)
#4-40	400	65	7
#6-32	400	70	11
#8-32	400	80	16
#10-32	400	90	17

Thread Size	Installation Force		
	(kN)	(N)	(N•m)
M3	1.80	285	.79
M4	1.80	355	1.80
M5	1.80	400	1.92



# Broaching Type Flare Mounted Threaded Standoffs

## Series CKFB3



CKFB3 flare mounted threaded standoffs provide a flared shank for stronger holding power and are used for spacing or stacking PC boards.

Series	Material	Finish
CKFB3	Brass CDA-360	Electro Tin Plating ASTM B545 Class B (Zinc* Optional)

Part Number Structure:

\*See Finish Spec. on Page 6.

CKFB3 440-2

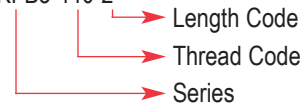

Thread: Internal 2B ANSI B1.1 (6H, ANSI/ASME B1.13M).  
Use in: Materials with Rockwell Hardness of B-65 or less.

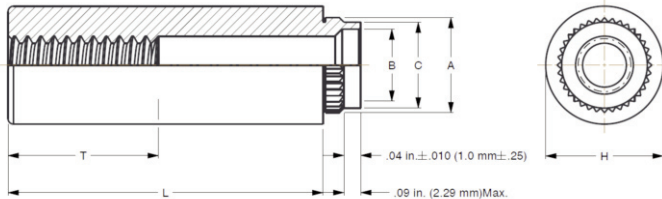

### Dimensions & Specifications

Thread Size	Part Number	L Length $\pm .005$ in.								A $\pm .003$	C Max.	B $\pm .003$	H $\pm .005$	+0.05 -0.01	Min.	Min.	
		.0625	.125	.187	.250	.312	.375	.500	.625								.750
INCH (in.)	#4-40	CKFB3440	-2	-4	-6	-8	-10	-12	-16	-20	.179	.165	.122	.218	.166	.17	.050
	#6-32	CKFB3632	-2	-4	-6	-8	-10	-12	-16	-20*	-24*	.226	.212	.171	.28	.213	.22
"T" Minimum thread length		Full								.375 $\pm$ .015							

### Dimensions & Specifications

Thread Size	Part Number	L Length $\pm .13$ mm									A $\pm .08$	C Max.	B $\pm .08$	H $\pm .13$	+0.13 -0.03	Min.	Min.	
		2	3	4	6	8	10	12	14	16								
METRIC (mm)	M3x0.5	CKFB3M3	-2	-3	-4	-6	-8	-10	-12	-14	-16	4.55	4.20	3.23	5.56	4.22	4.33	1.27
	M4x0.7	CKFB3M4	-2	-3	-4	-6	-8	-10	-12	-14	-16	6.68	6.33	5.23	8.74	6.40	6.36	1.65
"T" Minimum thread length		Full									9.5 $\pm$ .4							

### Installation & Performance Data

		Fiberglass .060 in. (1.5 mm)		
		Installation Force (lbs.)	Pushout (lbs.)	Torque-out (in.-lbs.)
INCH (in.)	#4-40	1000	140	18
	#6-32	1500	170	28
		Installation Force (kN)	Pushout (N)	Torque-out (N*m)
METRIC (mm)	M3	4.4	560	2.02
	M4	6.0	680	3.20

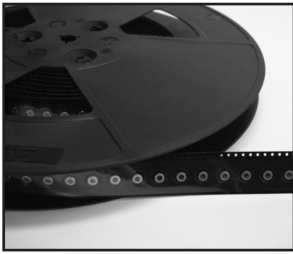

# Reel Mounted Spacers and Nuts

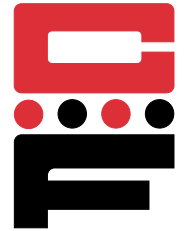

## Series CRM

CRM Reel Mount nuts and spacers provide a low-install-cost solution for surface mount hardware. The fasteners are fed from the recycleable reel using “pick and place” equipment and oriented prior to the reflow soldering operation.

Series	Material	Finish
CRM	Carbon Steel	Electro Tin Plating ASTM B545 Class A w/Preservative Coating

Thread: Internal 2B, ANSI B1.1 (6H, ANSI/ASME B1.13M).

Part Number Structure:

CRM- 440 - 4

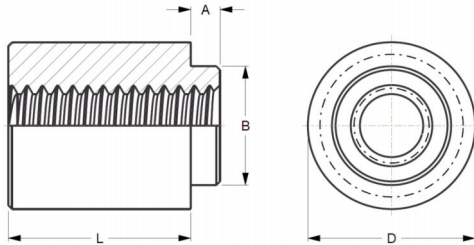

### Dimensions & Specifications

INCH (in.)	Thread Size	Series	Thread Code	Thru Hole +.004 -.003	L Length ±.005				A Max.	Min	+ .003 -.000	B Max	D ±.005	Min Solder Pad Ø
					.062	.125	.250	.375						
	#2-56	CRM	256		-2	-4	-8	-12	.060	.060	.147	.142	.219	.244
	#4-40	CRM	440		-2	-4	-8	-12	.060	.060	.166	.161	.219	.24
	#6-32	CRM	632		-2	-4	-8	-12	.060	.060	.213	.208	.281	.306
	#8-32	CRM	832		-2	-4	-8	-12	.060	.060	.250	.245	.344	.369
		CRM		.116	-2	-4	-8	-12	.060	.060	.166	.161	.219	.244
		CRM		.143	-2	-4	-8	-12	.060	.060	.213	.208	.281	.306

METRIC (mm.)	Thread Size	Series	Thread Code	Thru Hole +.10 -.08	L Length ±.13 mm						A Max.	Min	+ .08 -.00	B Max	D ±.13	Min Solder Pad Ø
					2	3	4	6	8	10						
	M2 x 0.4	CRM	M2		-2	-3	-4	-6	-8	-10	1.53	1.53	3.73	3.6	5.56	6.2
	M2.5 x 0.45	CRM	M2.5		-2	-3	-4	-6	-8	-10	1.53	1.53	4.22	4.09	5.56	6.2
	M3 x 0.5	CRM	M3		-2	-3	-4	-6	-8	-10	1.53	1.53	4.22	4.09	5.56	6.2
	M3.5 x 0.6	CRM	M3.5		-2	-3	-4	-6	-8	-10	1.53	1.53	5.41	5.28	7.14	7.77
	M4 x 0.7	CRM	M4		-2	-3	-4	-6	-8	-10	1.53	1.53	6.35	6.22	8.74	9.37
		CRM		3.6	-2	-3	-4	-6	-8	-10	1.53	1.53	5.41	5.28	7.14	7.77
		CRM		4.2	-2	-3	-4	-6	-8	-10	1.53	1.53	6.35	6.22	8.74	9.37

Note: All Items Subject to Minmun Order

Number of Parts per Reel / Pitch (mm) for Each Size - as per EIA standard (13" reels/24mm wide)

Thread Size & Thru Hole Size	Length						
	2	3	4	6	8	10	12
256, 440, 632, .116, .143	1500 / 12	--	1000 / 12	--	650 / 12	--	300 / 16
832	1100 / 16	--	800 / 16	--	500 / 16	--	300 / 16
M2, M2.5, M3, M3.5, 3.6	1500 / 12	1000 / 12	900 / 12	650 / 12	375 / 16	300 / 16	--
M4, 4.2	1100 / 16	800 / 16	675 / 16	500 / 16	375 / 16	200 / 16	--



# Broaching Type Spring-Top Standoffs

## Series CFKSSB



CFKSSB spring-top standoffs are designed for permanent installation into PC boards by pressing into a drilled or punched hole. The spring-action post provides quick attachment and removal of PC boards, with a simple snap eliminating the problems associated with loose hardware.

Series	Material	Finish
CFKSSB	CDA-360 Brass	None

Use in: PC Boards with Rockwell Hardness B-65 or less.

Part Number Structure:

CFKSSB 156-8

- Length Code
- Hole Diameter
- Series

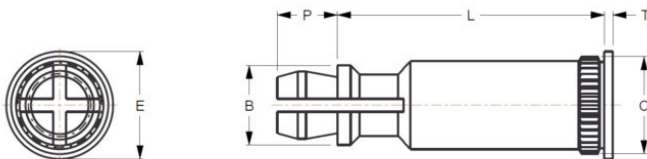

### Dimensions & Specifications

INCH (in.)	Series	Top Board Mounting Hole Diameter Code	Length L $\pm 0.005$ in. (Length Code In 32nds Of An Inch)										B $\pm 0.005$	C $\pm 0.003$	E $\pm 0.005$	P $\pm 0.005$	T $\pm 0.005$
			.250	.312	.375	.437	.500	.562	.625	.750	.875	1.000					
			Code														
	CFKSSB	156	-8	-10	-12	-14	-16	-18	-20	-24	-28	-32	.188	.226	.250	.141	.020

### Dimensions & Specifications

METRIC (mm)	Series	Top Board Mounting Hole Diameter Code	Length L $\pm 0.13$ mm (Length Code In Millimeters)									B $\pm 0.13$	C $\pm 0.08$	E $\pm 0.13$	P $\pm 0.13$	T $\pm 0.13$
			8	10	12	14	16	18	20	22	25					
			Code													
	CFKSSB	4 MM	-8	-10	-12	-14	-16	-18	-20	-22	-25	4.8	5.74	6.35	3.58	.51

Continued on next page.



# Broaching Type Spring-Top Standoffs

## Series CFKSSB

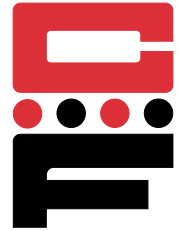

Continued from previous page.

### Installation & Performance Data

INCH (in.)	Series	Bottom Panel (Fixed)					Top Panel (Removable)				
		Bottom Mounting Hole +.003 -.000	Material	Hardness Max.	Thickness Min.	Location Tolerance Max.	Top Mounting Hole +.003 -.000	Material	Thickness Range	Min.	
CFKSSB	.213	PC board	HRB65	.050	.220	±.005	.156	PC board or metal	.040-.070	.100	

### Installation & Performance Data

INCH (in.)	Series	Bottom Panel (Fixed)			Top Panel (Removable)		
		Sheet Thickness & Sheet Material	Installation (lbs.)	Pushout (lbs.)	Max. first on force (lbs.)	Min. first off force (lbs.)	Min. 15th off force (lbs.)
CFKSSB	.060 FR-4 Fiberglass	500	110	13	3.0	1.0	

### Installation & Performance Data

METRIC (mm)	Series	Bottom Panel (Fixed)					Top Panel (Removable)				
		Bottom Mounting Hole +.08 -.00	Material	Hardness Max.	Thickness Min.	Location Tolerance Max.	Top Mounting Hole +.08 -.00	Material	Thickness Range	Min.	
CFKSSB	5.4	PC board	HRB65	1.25	5.6	±.13	4.0	PC board or metal	1-1.8	2.5	

### Installation & Performance Data

METRIC (mm)	Series	Bottom Panel (Fixed)			Top Panel (Removable)		
		Sheet Thickness & Sheet Material	Installation (kN)	Pushout (N)	Max. first on force (N)	Min. first off force (N)	Min. 15th off force (N)
CFKSSB	1.52 FR-4 Fiberglass	2.2	484	58	13	4.0	



# Broaching Type Panel Fasteners

## Series CPFK

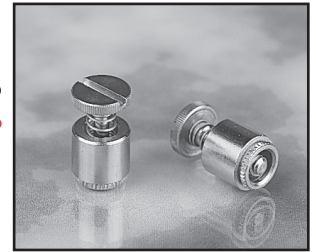

CPFK PC board panel fasteners provide permanent attachment of screw assemblies to PC board substrate material. Screw assemblies remain captive for easy mounting and removal of board.

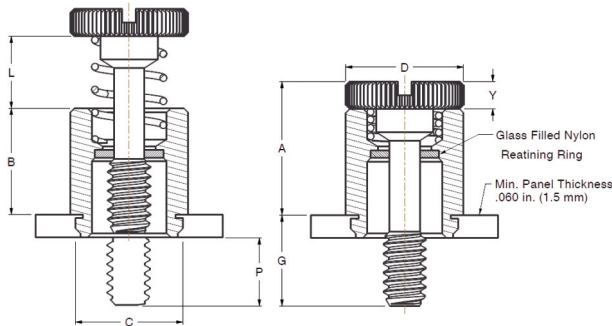

Series	Material	Finish
CPFK	300 Series Stainless Steel	Passivated ASTM A967

Thread: External 2A, ANSI B1.1 (6g ANSI/ASME B1.13M).\*  
Use in: PC Boards with Rockwell Hardness of B-70 or less.

\*See Note 3 on Page 6 for Gauging Spec.

### Dimensions & Specifications

	Thread Size	Part Number	G ±.016 in. (.4 mm)	P ±.016 in. (.4 mm)	L ±.016 in. (.4 mm)	D +.016 in. (.4mm) -.010 in. (.25 mm)	A Max.	Y ±.005 in. (.13 mm)	B ±.010 in. (.25mm)	C ±.003 in. (.08mm)	 +.003 in. (.08 mm) -.000(.00)	 Min.
INCH (in.)	#4-40	CPFK440-40	.250	.000	.19	.312	.36	.072	.28	.283	.265	.20
		CPFK440-62	.375	.125								
		CPFK440-84	.500	.250								
	#6-32	CPFK632-40	.250	.000	.19	.344	.36	.072	.28	.299	.281	.26
		CPFK632-62	.375	.125								
		CPFK632-84	.500	.250								
METRIC (mm)	M3 x 0.5	CPFKM3-40	6.4	.0	4.8	7.92	9.14	1.83	7.2	7.19	6.73	5.8
		CPFKM3-62	9.5	3.2								
		CPFKM3-84	12.7	6.4								

### Installation & Performance Data

	Thread Size	Fiberglass .060 in. (1.5 mm)		
		 Installation Force (lbs.)	 Pushout (lbs.)	 Torque-out (in.-lbs.)
INCH (in.)	#4-40	250	55	(1)
	#6-32	400	60	(1)
METRIC (mm)	Thread Size	Installation Force (kN)	Pushout (N)	Torque-out (N•m)
	M3	1.1	245	(3)





# Self-Clinching Low-Profile Panel Fastener

## Series LPH



LPH panel fasteners are preassembled for attachment to removable sheet metal panels. Screw assemblies remain captive for servicing ease and provide low profile when secure. Slotted head with deep skirt allows tool or finger operation.

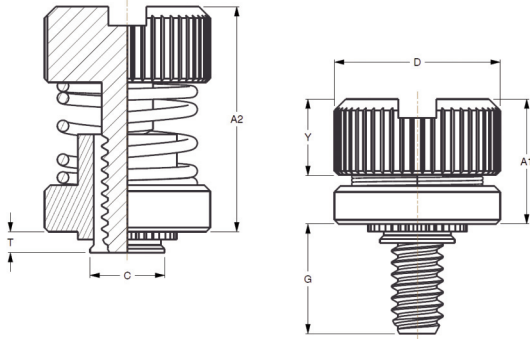

Series	Material	Finish*
LPH	Carbon Steel	Bright Nickel over Copper Flash

\*Black Nitride (BN) finish available

Thread: External 2A, ANSI B1.1 (6g ANSI/ASME B1.13M)\*\*  
Use in: Materials with Rockwell Hardness of B-60 or less.

Part Number Structure:

LPH-0 440-30

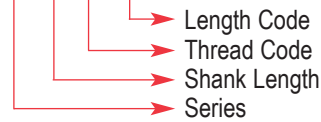

\*\*See Note 3 on Page 6 for Gauging Spec.

### Dimensions & Specifications

	Thread Size	Type	Thread Code	Screw Length Code	T		G ±.015	C Max.	D ±.010	Y ±.005	A1 Max.	A2 Nom.	Flatness			
					Min.	Max.							+0.003 -0.000	Min.		
INCH (in.)	#4-40	LPH-0	440	30	.030	.030	.300	.202	.406	.202	.325	.595	.203	.26		
		LPH-1			.040	.038									.060	.058
		LPH-2			.060	.058										
	#6-32	LPH-0	632	30	.030	.030	.300	.218	.438	.202	.325	.595	.219	.28		
		LPH-1			.040	.038									.060	.058
		LPH-2			.060	.058										
	#8-32	LPH-0	832	30	.030	.030	.300	.249	.468	.207	.330	.600	.250	.29		
		LPH-1			.040	.038									.060	.058
		LPH-2			.060	.058										
	#10-32	LPH-0	1032	30	.030	.030	.300	.311	.530	.220	.335	.605	.312	.33		
		LPH-1			.040	.038									.060	.058
		LPH-2			.060	.058										
1/4-20	LPH-2	420	35	.060	.058	.350	.374	.625	.242	.385	.675	.375	.38			
METRIC (mm)	M3 x 0.5	LPH-0	M3	30	.76	.76	7.62	5.48	10.31	5.13	8.26	15.11	5.5	6.6		
		LPH-1			1	.97									1.5	1.48
		LPH-2			1.5	1.48										
	M4 x 0.7	LPH-0	M4	30	.76	.76	7.62	6.38	11.89	5.26	8.38	15.24	6.4	7.37		
		LPH-1			1	.97									1.5	1.48
		LPH-2			1.5	1.48										
	M5 x 0.8	LPH-0	M5	30	.76	.76	7.62	7.98	13.46	5.59	8.51	15.37	8	8.38		
		LPH-1			1	.97									1.5	1.48
		LPH-2			1.5	1.48										
	M6 x 1	LPH-2	M6	35	1.5	1.48	8.89	9.48	15.88	6.12	9.78	17.15	9.5	9.65		

Continued on next page.







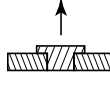

# Self-Clinching Low-Profile Panel Fastener

## Series LPH

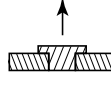

Continued from previous page.

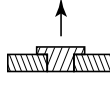
<b>Installation &amp; Performance Data</b>						
Type	Thread Code	Sheet Material				
		5052-H34 Aluminum		Cold-rolled Steel (B-60 Max)		
		 Installation Force (lbs.)	 Pushout (lbs.)	 Installaion Force (lbs.)	 Pushout (lbs.)	
INCH (in.)	LPH-0	440	2200	64	5000	90
	LPH-1			105		110
	LPH-2			185		300
	LPH-0	632	2400	66	5500	90
	LPH-1			105		130
	LPH-2			190		300
	LPH-0	832	2800	68	6000	90
	LPH-1			110		130
	LPH-2			200		300
	LPH-0	1032	3500	72	8000	95
	LPH-1			150		160
	LPH-2			260		425
LPH-2	420	4300	320	12000	450	

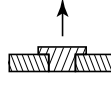
<b>Installation &amp; Performance Data</b>						
Type	Thread Code	Sheet Material				
		5052-H34 Aluminum		Cold-rolled Steel (B-60 Max)		
		 Installation Force (kN)	 Pushout (N)	 Installaion Force (kN)	 Pushout (N)	
METRIC (mm)	LPH-0	M3	9.8	285	22.2	400
	LPH-1			465		489
	LPH-2			823		1334
	LPH-0	M4	12.5	302	26.7	400
	LPH-1			489		578
	LPH-2			890		1334
	LPH-0	M5	15.6	320	35.6	423
	LPH-1			667		712
	LPH-2			1156		1890
	LPH-2	M6	19.1	1423	53.4	2002



# Self-Clinching Panel Fastener

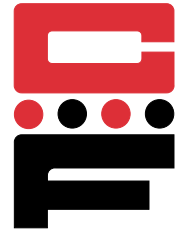

## Series CPFC2

CPFC2 panel fasteners provide permanent attachment of screw assemblies to removable sheet metal panels. Pre-assembled screw assemblies remain captive for easy mounting and removal of panel.

Series	Material	Finish
CPFC2	300 Series Stainless Steel	Passivated ASTM A967

Thread: External 2A, ANSI B1.1 (6g, ANSI/ASME B1.13M).

Use in: Materials with Rockwell Hardness B-70 or less.

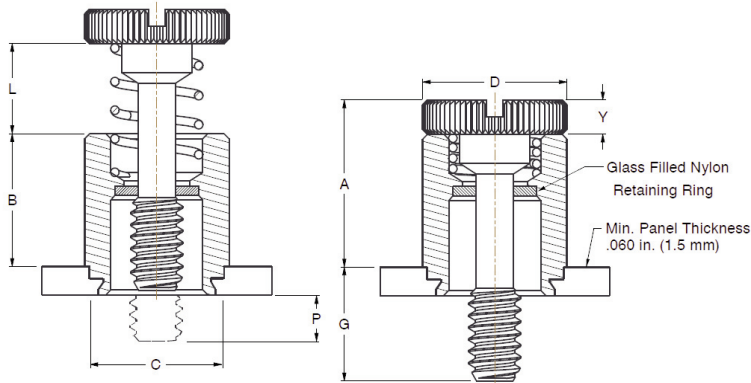

Part Number Structure:

CPFC2 440-40

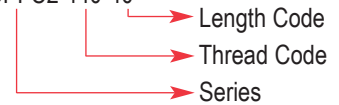

### Dimensions & Specifications

Thread Size	Part Number	G ±.016	P ±.016	L ±.016	D +.016 -.010	A Max.	Y ±.005	B ±.010	C Max.	 +.003 -.000	 Min.
#4-40	CPFC2440-40	.250	.000	.19	.312	.36	.072	.28	.264	.265	.25
	CPFC2440-62	.375	.125								
	CPFC2440-84	.500	.250								
#6-32	CPFC2632-40	.250	.000	.19	.344	.36	.072	.28	.280	.281	.28
	CPFC2632-62	.375	.125								
	CPFC2632-84	.500	.250								
#8-32	CPFC2832-50	.312	.000	.25	.375	.45	.082	.36	.311	.312	.31
	CPFC2832-72	.437	.125								
	CPFC2832-94	.562	.250								
#10-32	CPFC21032-50	.312	.000	.25	.406	.45	.082	.36	.343	.344	.34
	CPFC21032-72	.437	.125								
	CPFC21032-94	.562	.250								
1/4-20	CPFC2420-60	.375	.000	.31	.468	.58	.097	.47	.412	.413	.38
	CPFC2420-82	.500	.125								
	CPFC2420-04	.625	.250								

Continued on next page.



# Self-Clinching Panel Fasteners

## Series CPFC2



Continued from previous page.

### Dimensions & Specifications

Thread Size	Part Number	G	P	L	D	A	Y	B	C	+08 -00	Min.
		±.4	±.4	±.4	+4 -.25	Max.	±.13	±.25	Max.		
M3 x 0.5	CPFC2M3-40	6.4	.0	4.8	7.92	9.14	1.83	7.2	6.71	6.73	6.35
	CPFC2M3-62	9.5	3.2								
	CPFC2M3-84	12.7	6.4								
M4 x 0.7	CPFC2M4-50	7.9	.0	6.4	9.53	11.43	2.08	9.3	7.9	7.92	7.87
	CPFC2M4-72	11.1	3.2								
	CPFC2M4-94	14.3	6.4								
M5 x 0.8	CPFC2M5-50	7.9	.0	6.4	10.31	11.47	2.08	9.3	8.72	8.74	8.63
	CPFC2M5-72	11.1	3.2								
	CPFC2M5-94	14.3	6.4								
M6 x 1.0	CPFC2M6-60	9.5	.0	7.9	11.89	14.73	2.46	12.0	10.47	10.49	9.65
	CPFC2M6-82	12.7	3.2								
	CPFC2M6-04	15.9	6.4								

### Installation & Performance Data

Thread Size	Cold-rolled Steel		5052-H34 Aluminum		
	Installation Force (lbs.)	Pushout (lbs.)	Installation Force (lbs.)	Pushout (lbs.)	
INCH (in.)	#4-40	3000	300	2400	240
	#6-32	3500	350	2700	275
	#8-32	3800	400	2900	300
	#10-32	4000	500	3000	400
	1/4-20	5000	600	3500	400
	(kN)	(N)	(kN)	(N)	
METRIC (mm)	M3	13.3	1334	10.7	1068
	M4	16.9	1779	12.9	1334
	M5	17.8	2224	13.3	1779
	M6	22.2	2669	15.6	1779

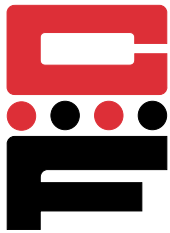

# Self-Clinching Collar Base Panel Fastener

## Series PSK/PSS



PS panel fastener are preassembled for attachment to removable sheet metal panels. Captive screw assemblies are spring loaded, for servicing ease, and provide low profile when secured. Combination cross-recess/slot head with knurled or smooth knob allows finger to tool operation. The base design has a collar that provides a mechanical stop when installed.

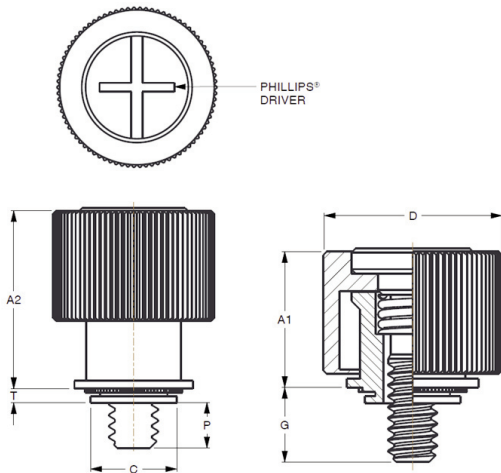

Series	Head	Material	Finish*
PSK	Knurled	Aluminum Knob	Natural
		Steel Base	Nickel/Copper ASTM B689
PSS	Smooth	Stainless Screw	Passivated ASTM A967

\* Black Nitride (BN) finish available

Thread: External 2A, ANSI B1.1 (6g, ANSI/ASME B1.13M).

Use in: Material with Rockwell Hardness of B-80 or less.

Part Number Structure:

PSK-440-0



### Dimensions & Specifications

	Thread Size	Driver Size	Type		Thread Code	Screw Length Code	Min.	T Max.	P ±.025	G ±.025	C Max.	D ±.010	A1 Nom.	A2 Nom.	+0.003 -0.000	Min.
			Knurled Head	Smooth Head												
INCH (in.)	440	#1	PSK	PSS	440	-0	.036	.036	.000	.170	.218	.417	.310	.450	.219	.28
						-1			.060	.230						
						-2			.120	.290						
	632	#2	PSK	PSS	632	-0	.036	.036	.000	.230	.249	.450	.450	.640	.250	.29
						-1			.060	.290						
						-2			.120	.350						
	832	#2	PSK	PSS	832	-0	.036	.036	.000	.230	.311	.514	.450	.640	.312	.33
						-1			.060	.290						
						-2			.120	.350						
	1032	#2	PSK	PSS	1032	-0	.036	.036	.000	.230	.311	.514	.450	.640	.312	.33
						-1			.060	.290						
						-2			.120	.350						
1/4-20	#2	PSK	PSS	420	-0	.036	.036	.000	.290	.374	.575	.530	.790	.375	.46	
					-1			.060	.350							
					-2			.120	.410							

Continued on next page.





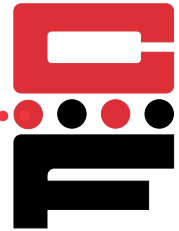

# Self-Clinching Collar Base Panel Fastener





## Series PSK/PSS



### Dimensions & Specifications

		Thread Size	Driver Size	Type		Thread Code	Screw Length Code		Min.	T Max.	P ±.64	G ±.64	C Max.	D ±.25	A1 Nom.	A2 Nom.		+0.08 -0.00		Min.	
				Knurled Head	Smooth Head																
METRIC (mm.)	M3x0.5	#1	PSK	PSS	M3	-0	.92	.92	0	4.32	5.54	10.59	7.87	11.43	5.56	7.11					
						-1															
						-2															
	M3.5x0.6	#2	PSK	PSS	M3.5	-0	.92	.92	0	5.84	6.33	11.43	11.43	16.26	6.35	7.37					
						-1															
						-2															
	M4x0.7	#2	PSK	PSS	M4	-0	.92	.92	0	5.84	7.9	13.06	11.43	16.26	7.92	7.38					
						-1															
						-2															
	M5x0.8	#2	PSK	PSS	M5	-0	.92	.92	0	5.84	7.9	13.06	11.43	16.26	7.92	7.38					
						-1															
						-2															
M6x1.0	#2	PSK	PSS	M6	-0	.92	.92	0	7.37	9.5	14.61	13.46	20.07	9.53	11.68						
					-1																
					-2																

### Installation & Performance Data

Type		Thread Code	Sheet Material			
			Aluminum		Cold-rolled Steel	
						
			Installation Force (lbs.)	Pushout (lbs.)	Installation Force (lbs.)	Pushout (lbs.)
PSK PSS		440	1500	80	2500	145
		632	2000	95	3500	150
		832	3000	100	4500	160
		1032	3000	100	4500	160
		420	3000	105	5000	195
Type		Thread Code	Installation Force (kN.)	Pushout (N)	Installation Force (kN.)	Pushout (N)
PSK PSS		M3	6.7	355	11.1	645
		M4	13.3	445	20	710
		M5	13.3	445	20	710
		M6	15.6	465	22.2	865



# Self-Clinching Standoffs

## Series CFSO, CFSOS & CFSOA (Through Threads)

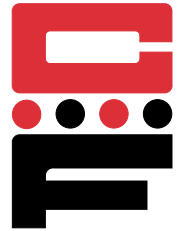

CFSO self-clinching standoffs are designed for quick, easy installation with any standard pneumatic, hydraulic or mechanical press. Through-threaded standoffs are used in metal panels with thickness of .040 in. (1.0 mm) and up. No secondary operation, such as reaming or deburring, is necessary prior to installation.

Series	Material	Finish
CFSO	Heat-treated Carbon Steel	Zinc* Clear
CFSOS	300 Series Stainless Steel	Passivated ASTM A967
CFSOA	7075-T6 Aluminum	None

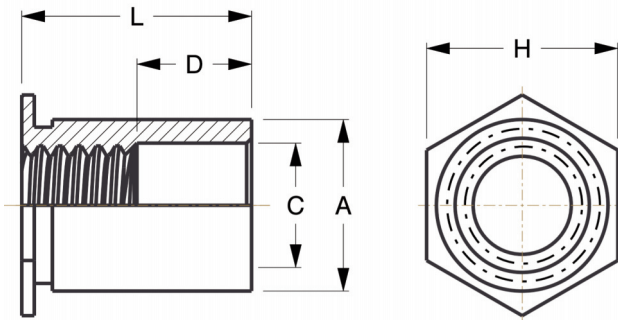

\*See Finish Spec. on Page 6.

Thread: Internal 2B, ANSI B1.1 (6H, ANSI/ASME B1.13M).

Use in: CFSO for materials with Rockwell Hardness of B-80 or less.

CFSOS for materials with Rockwell Hardness of B-70 or less.

CFSOA for materials with Rockwell Hardness of B-50 or less.

Part Number Structure:

CFSOS 6440-4



All Measurements In Inches.

### Dimensions & Specifications

Thread Size	Part Number	L Length +.002 -.005 in.															A Dim. + .003 - .000	H Hex Dim. (Nom.)	C Counter- bore ±.005	Min.	Min.			
		.125	.187	.250	.312	.375	.437	.500	.562	.625	.687	.750	.8125	.875	.9375	1.00						1.0625		
#4-40	CFSO 440	-4	-6	-8	-10	-12	-14	-16	-18	-20	-22	-24												
	CFSOS 440	-4	-6	-8	-10	-12	-14	-16	-18	-20	-22	-24							.166	.165	.187	.125	.23	.040
	CFSOA 440	-4	-6	-8	-10	-12	-14	-16	-18	-20	-22	-24												
#4-40	CFSO 6440	-4	-6	-8	-10	-12	-14	-16	-18	-20	-22	-24												
	CFSOS 6440	-4	-6	-8	-10	-12	-14	-16	-18	-20	-22	-24							.213	.212	.25	.125	.27	.040
	CFSOA 6440	-4	-6	-8	-10	-12	-14	-16	-18	-20	-22	-24												
D ±.0156		None			.1875			.3125			.4375													

Continued on next page.



# Self-Clinching Standoffs

## Series CFSO, CFSOS & CFSOA (Through Threads)



Continued from previous page.

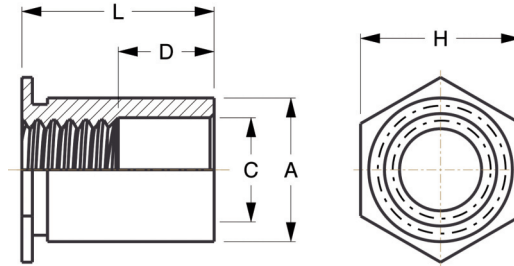

All Measurements In Inches.

### Dimensions & Specifications

Thread Size	Part Number	L Length +.002 -.005 in.															A Dim. +.003 -.000	H Hex Dim. (Nom.) .25	C Counter- bore ±.005	Min.	Min.		
		.125	.187	.250	.312	.375	.437	.500	.562	.625	.687	.750	.812	.875	.937	1.00						1.062	
#6-32	CFSO 632	-4	-6	-8	-10	-12	-14	-16	-18	-20	-22	-24	-26	-28	-30	-32	-34	.213	.212	.25	.156	.27	.04
	CFSOS 632	-4	-6	-8	-10	-12	-14	-16	-18	-20	-22	-24	-26	-28	-30	-32	-34						
	CFSOA 632	-4	-6	-8	-10	-12	-14	-16	-18	-20	-22	-24	-26	-28	-30	-32	-34						
#6-32	CFSO 8632	-4	-6	-8	-10	-12	-14	-16	-18	-20	-22	-24	-26	-28	-30	-32	-34	.281	.280	.312	.156	.31	.05
	CFSOS 8632	-4	-6	-8	-10	-12	-14	-16	-18	-20	-22	-24	-26	-28	-30	-32	-34						
	CFSOA 8632	-4	-6	-8	-10	-12	-14	-16	-18	-20	-22	-24	-26	-28	-30	-32	-34						
#8-32	CFSO 832	-4	-6	-8	-10	-12	-14	-16	-18	-20	-22	-24	-26	-28	-30	-32	-34	.281	.280	.312	.188	.31	.05
	CFSOS 832	-4	-6	-8	-10	-12	-14	-16	-18	-20	-22	-24	-26	-28	-30	-32	-34						
	CFSOA 832	-4	-6	-8	-10	-12	-14	-16	-18	-20	-22	-24	-26	-28	-30	-32	-34						
#10-32	CFSO 1032	-4	-6	-8	-10	-12	-14	-16	-18	-20	-22	-24	-26	-28	-30	-32	-34	.281	.280	.312	.203	.31	.05
	CFSOS 1032	-4	-6	-8	-10	-12	-14	-16	-18	-20	-22	-24	-26	-28	-30	-32	-34						
	CFSOA 1032	-4	-6	-8	-10	-12	-14	-16	-18	-20	-22	-24	-26	-28	-30	-32	-34						
D ±.0156		None			.1875			.3125			.4375												

Continued on next page.





# Self-Clinching Standoffs

## Series CFSO, CFSOS & CFSOA (Through Threads)



Continued from previous page.

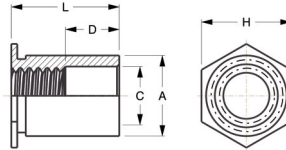

All Measurements In Millimeters.

### Dimensions & Specifications

Thread Size	Part Number	L Length +05 -0.13 mm												 +08 -0.00	A Dim. +0.00 -0.13	H Hex Dim. (Nom.)	C Counter- bore ±0.13	 Min.	 Min.
		3	4	6	8	10	12	14	16	18	20	22	25						
M3x0.5	CFSO M3	-3	-4	-6	-8	-10	-12	-14	-16	-18				4.22	4.2	4.8	3.2	6.0	1.0
	CFSOS M3	-3	-4	-6	-8	-10	-12	-14	-16	-18									
	CFSOA M3	-3	-4	-6	-8	-10	-12	-14	-16	-18									
M3x0.5	CFSO 3.5M3	-3	-4	-6	-8	-10	-12	-14	-16	-18				5.41	5.39	6.4	3.2	6.8	1.0
	CFSOS 3.5M3	-3	-4	-6	-8	-10	-12	-14	-16	-18									
	CFSOA 3.5M3	-3	-4	-6	-8	-10	-12	-14	-16	-18									
M3.5x0.6	CFSO M3.5	-3	-4	-6	-8	-10	-12	-14	-16	-18	-20	-22	-25	5.41	5.39	6.4	4.0	6.8	1.0
	CFSOS M3.5	-3	-4	-6	-8	-10	-12	-14	-16	-18	-20	-22	-25						
	CFSOA M3.5	-3	-4	-6	-8	-10	-12	-14	-16	-18	-20	-22	-25						
M4x0.7	CFSO M4	-3	-4	-6	-8	-10	-12	-14	-16	-18	-20	-22	-25	7.14	7.12	7.9	4.8	8.0	1.27
	CFSOS M4	-3	-4	-6	-8	-10	-12	-14	-16	-18	-20	-22	-25						
	CFSOA M4	-3	-4	-6	-8	-10	-12	-14	-16	-18	-20	-22	-25						
M5x0.8	CFSO M5	-3	-4	-6	-8	-10	-12	-14	-16	-18	-20	-22	-25	7.14	7.12	7.9	5.35	8.0	1.27
	CFSOS M5	-3	-4	-6	-8	-10	-12	-14	-16	-18	-20	-22	-25						
	CFSOA M5	-3	-4	-6	-8	-10	-12	-14	-16	-18	-20	-22	-25						
D ±.4		None			4.0			8.0			11.0								

Continued on next page.



# Self-Clinching Standoffs

## Series CFBSO, CFBSOS & CFBSOA (Blind Threads)

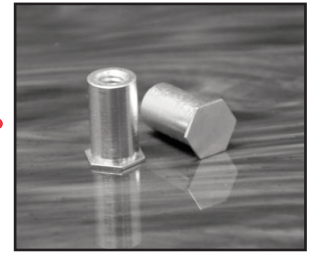

CFBSO self-clinching standoffs are designed for quick, easy installation with any standard pneumatic, hydraulic or mechanical press. Blind standoffs are used in metal panels with thickness of .040 in. (1.0 mm) and up. No secondary operation, such as reaming or deburring, is necessary prior to installation.

Series	Material	Finish
CFBSO	Heat-treated Carbon Steel	Zinc* Clear
CFBSOS	300 Series Stainless Steel	Passivated ASTM A967
CFBSOA	7075-T6 Aluminum	None

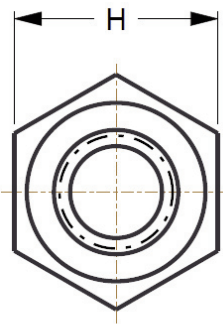
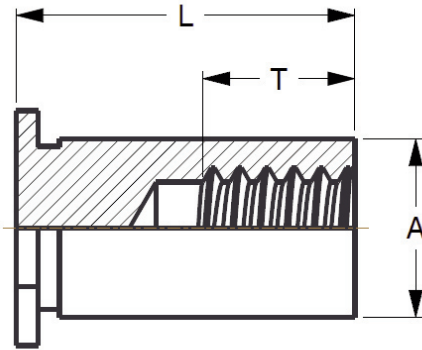

\*See Finish Spec. on Page 6.

Thread: Internal 2B ANSI B1.1 (6H, ANSI/ASME B1.13M).

Use in: CFBSO for materials with Rockwell Hardness of B-80 or less.

CFBSOS for materials with Rockwell Hardness of B-70 or less.

CFBSOA for materials with Rockwell Hardness of B-50 or less.

Part Number Structure:

CFBSOS 6440-10

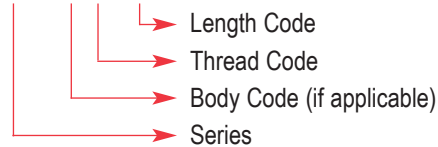

All Measurements In Inches.

### Dimensions & Specifications

Thread Size	Part Number	L Length +.002 -.005 in.													A Dim. +.003 -.000	H Hex Dim. (Nom.)	Min.	Min.	
		.312	.375	.437	.500	.562	.625	.687	.750	.812	.875	.937	1.00	1.062					
#4-40	CFBSO 440	-10	-12	-14	-16	-18	-20	-22	-24	-26	-28	-30	-32	-34	.166	.165	.187	.23	.040
	CFBSOS 440	-10	-12	-14	-16	-18	-20	-22	-24	-26	-28	-30	-32	-34					
	CFBSOA 440	-10	-12	-14	-16	-18	-20	-22	-24	-26	-28	-30	-32	-34					
#4-40	CFBSO 6440	-10	-12	-14	-16	-18	-20	-22	-24	-26	-28	-30	-32	-34	.213	.212	.25	.27	.040
	CFBSOS 6440	-10	-12	-14	-16	-18	-20	-22	-24	-26	-28	-30	-32	-34					
	CFBSOA 6440	-10	-12	-14	-16	-18	-20	-22	-24	-26	-28	-30	-32	-34					
T Min.		.156	.187	.25			.375												

Continued on next page.



# Self-Clinching Standoffs



## Series CFBSO, CFBSOS & CFBSOA (Blind Threads)

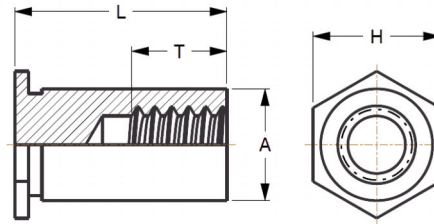

Continued from previous page.



All Measurements In Inches.

Dimensions & Specifications																			
Thread Size	Part Number	L Length +.002 -.005 in.													 +.003 -.000	A Dim. +.000 -.005	H Hex Dim. (Nom.)	 Min.	 Min.
		.312	.375	.437	.500	.562	.625	.687	.750	.812	.875	.937	1.00	1.062					
#6-32	CFBSO 632	-10	-12	-14	-16	-18	-20	-22	-24	-26	-28	-30	-32	-34	.213	.212	.25	.27	.04
	CFBSOS 632	-10	-12	-14	-16	-18	-20	-22	-24	-26	-28	-30	-32	-34					
	CFBSOA 632	-10	-12	-14	-16	-18	-20	-22	-24	-26	-28	-30	-32	-34					
#6-32	CFBSO 8632	-10	-12	-14	-16	-18	-20	-22	-24	-26	-28	-30	-32	-34	.281	.280	.312	.31	.05
	CFBSOS 8632	-10	-12	-14	-16	-18	-20	-22	-24	-26	-28	-30	-32	-34					
	CFBSOA 8632	-10	-12	-14	-16	-18	-20	-22	-24	-26	-28	-30	-32	-34					
#8-32	CFBSO 832	-10	-12	-14	-16	-18	-20	-22	-24	-26	-28	-30	-32	-34	.281	.280	.312	.31	.05
	CFBSOS 832	-10	-12	-14	-16	-18	-20	-22	-24	-26	-28	-30	-32	-34					
	CFBSOA 832	-10	-12	-14	-16	-18	-20	-22	-24	-26	-28	-30	-32	-34					
#10-32	CFBSO 1032	-10	-12	-14	-16	-18	-20	-22	-24	-26	-28	-30	-32	-34	.281	.280	.312	.31	.05
	CFBSOS 1032	-10	-12	-14	-16	-18	-20	-22	-24	-26	-28	-30	-32	-34					
	CFBSOA 1032	-10	-12	-14	-16	-18	-20	-22	-24	-26	-28	-30	-32	-34					
T Min.		.156	.187	.25				.375											

Continued on next page.



# Self-Clinching Standoffs

## Series CFBSO, CFBSOS & CFBSOA (Blind Threads)



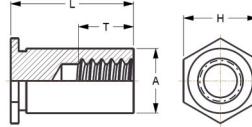

Continued from previous page.



All Measurements In Millimeters.

### Dimensions & Specifications

Thread Size	Part Number	L Length +.05 -.13 mm										 +.08 -.00	A Dim. +.00 -.13	H Hex Dim. (Nom.)	 Min.	 Min.
		6	8	10	12	14	16	18	20	22	25					
M3x0.5	CFBSO M3	-6	-8	-10	-12	-14	-16	-18	-20	-22	-25	4.22	4.2	4.8	6.0	1.0
	CFBSOS M3	-6	-8	-10	-12	-14	-16	-18	-20	-22	-25					
	CFBSOA M3	-6	-8	-10	-12	-14	-16	-18	-20	-22	-25					
M3x0.5	CFBSO 3.5M3	-6	-8	-10	-12	-14	-16	-18	-20	-22	-25	5.41	5.39	6.4	6.8	1.0
	CFBSOS 3.5M3	-6	-8	-10	-12	-14	-16	-18	-20	-22	-25					
	CFBSOA 3.5M3	-6	-8	-10	-12	-14	-16	-18	-20	-22	-25					
M3.5x0.6	CFBSO M3.5	-6	-8	-10	-12	-14	-16	-18	-20	-22	-25	5.41	5.39	6.4	6.8	1.0
	CFBSOS M3.5	-6	-8	-10	-12	-14	-16	-18	-20	-22	-25					
	CFBSOA M3.5	-6	-8	-10	-12	-14	-16	-18	-20	-22	-25					
M4x0.7	CFBSO M4	-6	-8	-10	-12	-14	-16	-18	-20	-22	-25	7.14	7.12	7.9	8.0	1.27
	CFBSOS M4	-6	-8	-10	-12	-14	-16	-18	-20	-22	-25					
	CFBSOA M4	-6	-8	-10	-12	-14	-16	-18	-20	-22	-25					
M5x0.8	CFBSO M5	-6	-8	-10	-12	-14	-16	-18	-20	-22	-25	7.14	7.12	7.9	8.0	1.27
	CFBSOS M5	-6	-8	-10	-12	-14	-16	-18	-20	-22	-25					
	CFBSOA M5	-6	-8	-10	-12	-14	-16	-18	-20	-22	-25					
T Min.		3.2	4.0	5.0	6.5	9.5										

Continued on next page.







# Self-Clinching Standoffs

Series CFSO, CFSOS, CFSOA,  
CFBSO, CFBSOS & CFBSOA

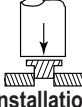

Continued from previous page.

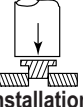
## Installation & Performance Data

		Sheet Material: .060 in. 5052-H34 Aluminum					.060 in. Cold-rolled Steel				
Thread Code	Standoff Material	 Installation Force (lbs.)	 Pushout (lbs.)	 Torque-out (in.-lbs.)	Pull Through (lbs.)	 Installation Force (lbs.)	 Pushout (lbs.)	 Torque-out (in.-lbs.)	Pull Through (lbs.)	Rec. Tighten Torque Max. (in.-lbs.)	
		INCH (in.)	440	Steel	1100	160	11	280	2200	225	19
Stainless Steel	1100			160	11	224	2200	225	19	264	3.8
Aluminum	1100			160	11	168	nr	nr	nr	nr	2.85
6440, 632	Steel		1700	300	25	280	3300	420	35	380	4.75, 8.75
	Stainless Steel		1700	300	25	248	3300	420	35	304	3.8, 7
	Aluminum		1700	300	25	186	nr	nr	nr	nr	2.85, 5.25
8632, 832, 1032	Steel		2400	400	45	580	4000	560	75	700	8.75, 18, 32
	Stainless Steel		2400	400	45	464	4000	560	75	560	7, 14.4, 25.6
	Aluminum		2400	400	45	348	nr	nr	nr	nr	5.25, 11, 19
		Sheet Material: 1.5mm 5052-H34 Aluminum					1.5mm Cold-rolled Steel				
Thread Code	Standoff Material	Installation Force (kN)	Pushout (N)	Torque-out (N·m)	Pull Through (N)	Installation Force (kN)	Pushout (N)	Torque-out (N·m)	Pull Through (N)	Rec. Tighten Torque Max. (N·m)	
		METRIC (mm)	M3	Steel	4.9	710	1.24	1245	9.8	1000	2.15
Stainless Steel	4.9			710	1.24	996	9.8	1000	2.15	1172	.44
Aluminum	4.9			710	1.24	747	nr	nr	nr	nr	.33
3.5M3	Steel		7.6	1330	2.82	1245	14.7	1860	3.95	1465	.55
	Stainless Steel		7.6	1330	2.82	996	14.7	1860	3.95	1172	.44
	Aluminum		7.6	1330	2.82	747	nr	nr	nr	nr	.33
M4, M5	Steel		10.7	1780	5.08	2575	17.8	2490	8.47	3110	2, 3.6
	Stainless Steel		10.7	1780	5.08	2060	17.8	2490	8.47	2488	1.6, 2.88
	Aluminum		10.7	1780	5.08	1545	nr	nr	nr	nr	1.2, 2.16

nr = Not recommended.

### RECOMMENDED INSTALLATION PROCEDURE

1. Insert Standoff through hole in sheet into anvil.
2. Apply only sufficient squeezing force between parallel surfaces of punch and anvil to embed hex head flush in sheet. Avoid excessive pressures.

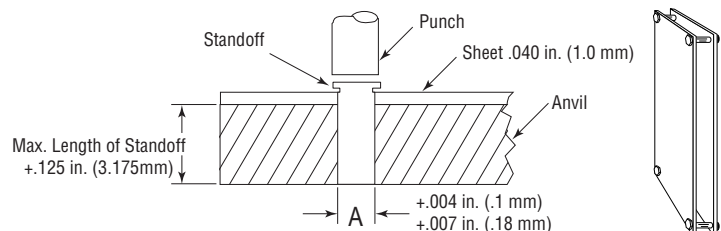

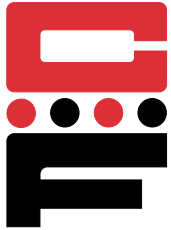

# Self-Clinching Grounding Standoffs

## Series CFSOSG & CFSOAG



CFSOSG & CFSOAG self-grounding standoffs are designed to be installed in steel and aluminum chassis to ground PC boards. Projecting teeth assure excellent electrical contact with PC board circuit and eliminate need for serrated or star washers.

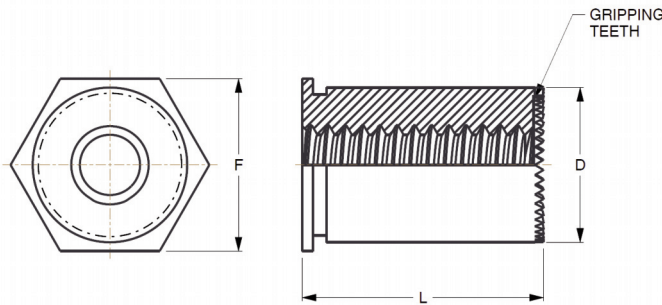

† Not stocked, available on special order.

Series	Material	Finish
CFSOSG	300 Series Stainless Steel	Passivated ASTM A967
CFSOAG	7075-T6 Aluminum	None

Thread: Internal 2B ANSI B1.1 (6H, ANSI/ASME B1.13M).

Use in: CFSOSG for materials with Rockwell Hardness of B-70 or less.

CFSOAG for materials with Rockwell Hardness of B-50 or less.

### Dimensions & Specifications

INCH (in.)	Thread	Part Numbers	L Length +.010 -.000 in.								F Hex Dim. (Nom.)	D +.000 -.005		
			Stainless	Aluminum	.125	.187	.250	.312	.375	.437				
#4-40	CFSOSG6440	CFSOAG6440	-4 <sup>†</sup>	-6	-8	-10	-12	-14	-16	.250	.212	.213	.27	
#6-32	CFSOSG8632	CFSOAG8632	-4 <sup>†</sup>	-6 <sup>†</sup>	-8	-10	-12	-14	-16	.312	.280	.281	.31	
METRIC (mm)	Thread	Part Numbers	L Length +.25 - .00 mm								F Hex Dim. (Nom.)	D +.00 -.13		
			Stainless	Aluminum	3	4	6	8	10	12				
M3x0.5	CFSOSG3.5M3	CFSOAG3.5M3	-3	-4	-6	-8	-10	-12	-14	6.4	5.39	5.41	6.86	

### Installation & Performance Data

INCH (in.)	Thread Size	5052-H34 Aluminum			
		 Min.	 Installation Force (lbs.)	 Pushout (lbs.)	 Torque- out (in.-lbs.)
#4-40	.040	1500-2000	300	25	
#6-32	.050	1500-2000	400	45	
METRIC (mm)	Thread Size	Min.	Installation Force (kN)	Pushout (N)	Torque- out (N•m)

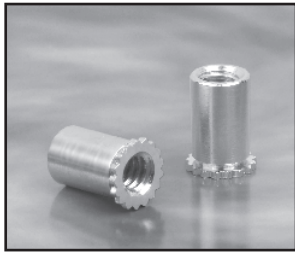

# Self-Clinching Miniature Standoffs

## Series CF40 & CF40S (Miniature Standoff)



CF40 & CF40S Miniature Standoffs are designed to be used in limited space applications. They are ideal for securing D-sub connectors to enclosure backplanes and provide a flush mounting surface for RFI/EMI gaskets.

Series	Material	Finish
CF40	Heat-treated Carbon Steel	Zinc* Clear
CF40S	300 Series Stainless Steel	Passivated ASTM A967

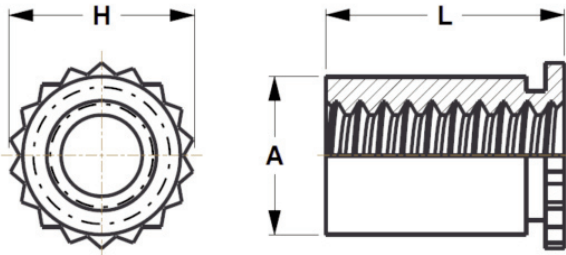

\*See Finish Spec. on Page 6.

Thread: Internal 2B ANSI B1.1 (6H, ANSI/ASME B1.13M).

Use in: CF40 for Material with HRB-80 or less.

CF40S for Material with HRB-70 or less.

Part Number Structure:

CF40 - 440 - .250



All Measurements In Inches.

Dimensions & Specifications									
Thread Size	Part Number		L Length +.002 -.005 in.		+.003 -.000	A Dim. Max.	H Dim. (Nom.)	Min.	Min.
	Steel	Stainless Steel							
#4-40	CF40-440	CF40S-440	-.250	-.275	.166	.165	.194	.126	.037-.250

All Measurements In Millimeters.

Dimensions & Specifications									
Thread Size	Part Number		L Length +.05 -.13mm		+.08 -.00	A Dim. Max.	H Dim. (Nom.)	Min.	Min.
	Steel	Stainless Steel							
M3 x 0.5	CF40-M3	CF40S-M3	-6.35	-7	4.22	4.2	4.92	3.2	.94-6.35

Continued on next page.







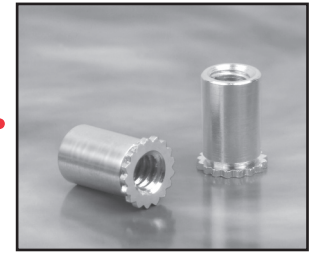

# Self-Clinching Miniature Standoffs



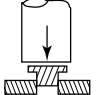



## Series CF40 & CF40S (Miniature Standoff)

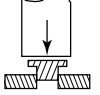

Continued from previous page.

### Installation & Performance Data

INCH (in.)	Sheet Material: .040 in. Cold-rolled Steel						Sheet Material: .040 in. 5052-H34 Aluminum						
						Rec. Tightening Torque Max. (in.-lbs.)						Rec. Tightening Torque Max. (in.-lbs.)	
	Thread Code	Material	Installation Force (lbs.)	Pushout (lbs.)	Torque-out (in.-lbs.)		Thread Code	Material	Installation Force (lbs.)	Pushout (lbs.)	Torque-out (in.-lbs.)		
440		Steel	1300	75	10	3.8	440		Steel	1000	50	10	3.8
		Stainless Steel	1300	75	10	3.8			Stainless Steel	1000	50	10	3.8

METRIC (mm)	Sheet Material: 1mm Cold-rolled Steel						Sheet Material: 1mm 5052-H34 Aluminum						
						Rec. Tightening Torque Max. (N•m)						Rec. Tightening Torque Max. (N•m)	
	Thread Code	Material	Installation Force (kN)	Pushout (N)	Torque-out (N•m)		Thread Code	Material	Installation Force (kN)	Pushout (N)	Torque-out (N•m)		
M3		Steel	5.8	334	1.1	.44	M3		Steel	4.5	223	1.1	.44
		Stainless Steel	5.8	334	1.1	.44			Stainless Steel	4.5	223	1.1	.44



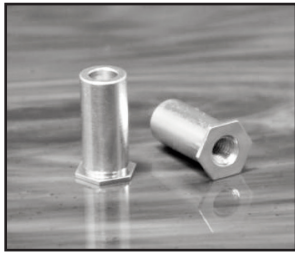

# Self-Clinching Standoffs for Stainless Steel



## Series CF4-SO (400 Series Standoffs)

CF4-SO Standoffs are designed to be pressed into round holes in stainless steel material as thin as .040 (1mm). The through-hole versions are available in a choice of inch and metric sizes.

Series	Material	Finish
CF4-SO	400 Series Stainless Steel	Passivated ASTM A967

Thread: Internal 2B, ANSI B1.1 (6H, ANSI/ASME B1.13M).  
Use in: Materials with Rockwell Hardness of B88 or less.

Part Number Structure:

CF4-SO 6440-4

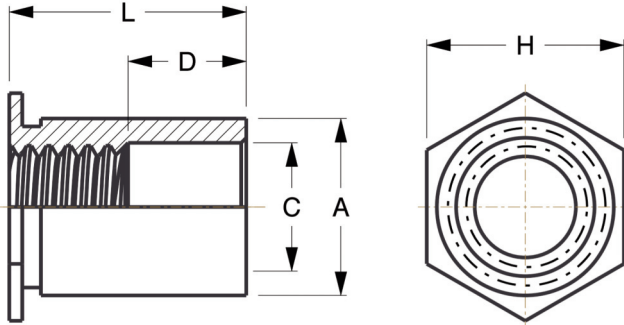
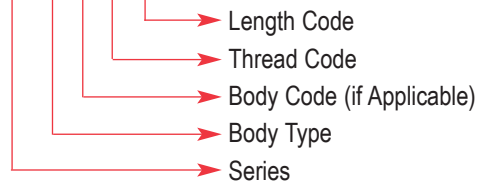

All Measurements In Inches.

### Dimensions & Specifications

Thread Size	Part Number	L Length +.002 -.005 in.														A Dim. +.003 -.000	H Hex Dim. (Nom.)	C Counter-bore ±.005	Min.	Min.			
		.125	.187	.250	.312	.375	.437	.500	.562	.625	.687	.750	.812	.875	.937						1.00	1.062	
#4-40	CF4-SO 440	-4	-6	-8	-10	-12	-14	-16	-18	-20	-22	-24					.166	.165	.187	.125	.23	.040	
	CF4-SO 6440	-4	-6	-8	-10	-12	-14	-16	-18	-20	-22	-24					.213	.212	.250	.125	.27	.040	
#6-32	CF4-SO 632	-4	-6	-8	-10	-12	-14	-16	-18	-20	-22	-24	-26	-28	-30	-32	-34	.213	.212	.250	.156	.27	.040
	CF4-SO 8632	-4	-6	-8	-10	-12	-14	-16	-18	-20	-22	-24	-26	-28	-30	-32	-34	.281	.280	.312	.156	.31	.050
#8-32	CF4-SO 832	-4	-6	-8	-10	-12	-14	-16	-18	-20	-22	-24	-26	-28	-30	-32	-34	.281	.280	.312	.188	.31	.050
#10-32	CF4-SO 1032	-4	-6	-8	-10	-12	-14	-16	-18	-20	-22	-24	-26	-28	-30	-32	-34	.281	.280	.312	.203	.31	.050
D ±.010		None				.187				.312				.437									

All Measurements In Millimeters.

Thread Size	Part Number	L Length +.05 -.13 mm												A Dim. +.08 -.00	H Hex Dim. (Nom.)	C Counter-bore ±.13	Min.	Min.					
		3	4	6	8	10	12	14	16	18	20	22	25										
M3x0.5	CF4-SO M3	-3	-4	-6	-8	-10	-12	-14	-16	-18				4.22	4.2	4.8	3.2	6	1.02				
	CF4-SO 3.5M3	-3	-4	-6	-8	-10	-12	-14	-16	-18				5.41	5.39	6.4	3.2	6.8	1.02				
M3.5x0.6	CF4-SO M3.5	-3	-4	-6	-8	-10	-12	-14	-16	-18	-20	-22	-25	5.41	5.39	6.4	3.9	6.8	1.02				
M4x0.7	CF4-SO M4	-3	-4	-6	-8	-10	-12	-14	-16	-18	-20	-22	-25	7.14	7.12	7.9	4.8	8	1.27				
M5x0.8	CF4-SO M5	-3	-4	-6	-8	-10	-12	-14	-16	-18	-20	-22	-25	7.14	7.12	7.9	5.35	8	1.27				
D ±.25		None				4.0				8.0				11.0									

Continued on next page.



# Self-Clinching Standoffs for Stainless Steel

## Series CF4-BSO (400 Series Blind Standoffs)



Continued from previous page.

CF4-BSO Standoffs are designed to be pressed into round holes in stainless steel material as thin as .040 (1mm). The blind-hole versions are available in a choice of inch and metric sizes.

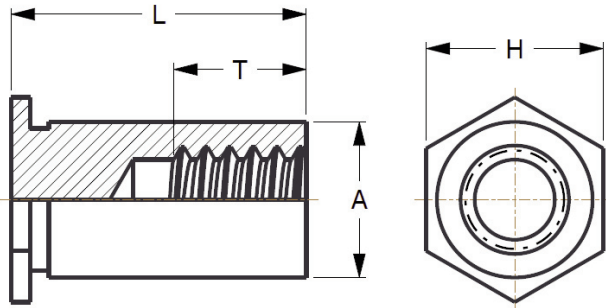

Series	Material	Finish
CF4-BSO	400 Series Stainless Steel	Passivated ASTM A967

Thread: Internal 2B, ANSI B1.1 (6H, ANSI/ASME B1.13M).

Use in: Materials with Rockwell Hardness of B88 or less.

Part Number Structure:

CF4-BSO 6440-10

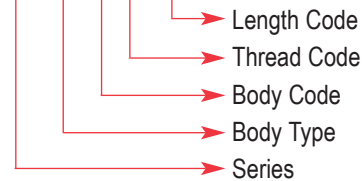

All Measurements In Inches.

### Dimensions & Specifications

Thread Size	Part Number	L Length +.002 -.005 in.													+003 -000	A Dim. +.000 -.005	H Hex Dim. (Nom.)	Min.	Min.
		.312	.375	.437	.500	.562	.625	.687	.750	.812	.875	.937	1.00	1.062					
#4-40	CF4-BSO 440	-10	-12	-14	-16	-18	-20	-22	-24	-26	-28	-30	-32	-34	.166	.165	.187	.23	.040
	CF4-BSO 6440	-10	-12	-14	-16	-18	-20	-22	-24	-26	-28	-30	-32	-34	.213	.212	.250	.27	.040
#6-32	CF4-BSO 632	-10	-12	-14	-16	-18	-20	-22	-24	-26	-28	-30	-32	-34	.213	.212	.250	.27	.040
	CF4-BSO 8632	-10	-12	-14	-16	-18	-20	-22	-24	-26	-28	-30	-32	-34	.281	.280	.312	.31	.050
#8-32	CF4-BSO 832	-10	-12	-14	-16	-18	-20	-22	-24	-26	-28	-30	-32	-34	.281	.280	.312	.31	.050
#10-32	CF4-BSO 1032	-10	-12	-14	-16	-18	-20	-22	-24	-26	-28	-30	-32	-34	.281	.280	.312	.31	.050
T Dim. Min.		.156		.187		.250			.375										

All Measurements In Millimeters.

Thread Size	Part Number	L Length +.05 -.13 mm											+08 -00	A Dim. +.00 -.13	H Hex Dim. (Nom.)	Min.	Min.
		6	8	10	12	14	16	18	20	22	25						
M3x0.5	CF4-BSO M3	-6	-8	-10	12	-14	-16	-18	-20	-22	-25	4.22	4.2	4.8	6	1	
	CF4-BSO 3.5M3	-6	-8	-10	12	-14	-16	-18	-20	-22	-25	5.41	5.39	6.4	6.8	1	
M3.5x0.6	CF4-BSO M3.5	-6	-8	-10	12	-14	-16	-18	-20	-22	-25	5.41	5.39	6.4	6.8	1	
M4x0.7	CF4-BSO M4	-6	-8	-10	12	-14	-16	-18	-20	-22	-25	7.14	7.12	7.9	8	1.27	
M5x0.8	CF4-BSO M5	-6	-8	-10	12	-14	-16	-18	-20	-22	-25	7.14	7.12	7.9	8	1.27	
T Dim. Min.		3.2		4.0		5.0		6.5			9.5						

Continued on next page.



# Self-Clinching Standoffs for Stainless Steel

## Series CF4-SO & CF4-BSO (400 Series Standoffs)

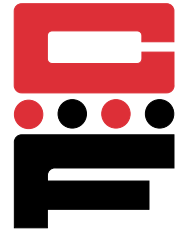

Continued from previous page.

### Installation & Performance Data

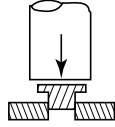
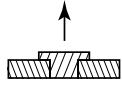
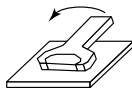
Sheet Material: .050 in. 300 Series Stainless Steel						
INCH (in.)						
	Thread Code	Installation Force (lbs.)	Pushout (lbs.)	Torque-out (in.-lbs.)	Pull Through (lbs.)	Rec. Tightening Torque Max. (in.-lbs.)
	440	5500	336	17	600	4.75
	6440	9500	647	30	680	4.75
	632	9500	647	30	680	8.75
	8632	10500	900	71	1392	8.75
	832	10500	900	71	1517	18
1032	10500	900	71	1368	32	

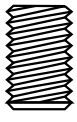
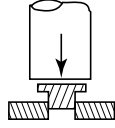
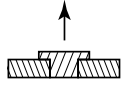
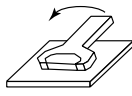
Sheet Material: 1.3mm 300 Series Stainless Steel						
METRIC (mm)						
	Thread Code	Installation Force (kN)	Pushout (N)	Torque-out (N•m)	Pull Through (N)	Rec. Tightening Torque Max. (N•m)
	M3	24.5	1493	2.36	2650	.55
	3.5 M3	42.3	2877	3.06	3025	.55
	M3.5	42.3	2877	3.06	3025	.91
	M4	46.7	4003	8.89	6458	2
	M5	46.7	4003	8.89	6226	3.6

#### RECOMMENDED INSTALLATION PROCEDURE

1. Insert Standoff through hole in sheet into anvil.
2. Apply sufficient squeezing force between parallel surfaces of punch and anvil to embed hex head flush in sheet. Avoid excessive pressure.

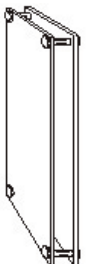
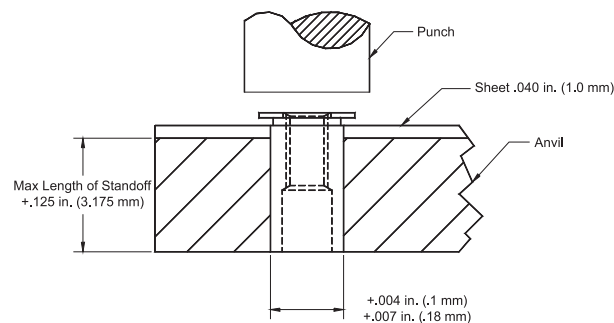



# Self-Clinching Slide-Top Standoffs

## Series CFSKC



CFSKC slide-top standoffs are designed for a PC board or panel to be quickly attached and removed with a simple sliding motion. The slide-top standoffs provide advantages for reducing servicing time and eliminate the problems associated with loose hardware. Several slide-top standoffs can be used in conjunction with a Captive threaded standoff to lock the board in place.

Series	Material	Finish
CFSKC	300 Series Stainless Steel	Passivated ASTM A967

Use in: Materials HRB-70 or less.

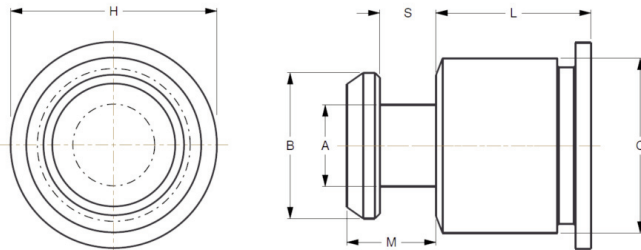

Part Number Structure:

CFSKC 6060-6

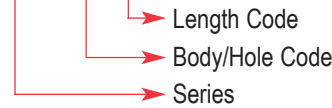

### Dimensions & Specifications

INCH (in.)	Series	Body/ Hole Code	L Length $\pm .005$ in. Length Code is in 32nds of an Inch										A $\pm .003$	B $\pm .003$	C Max.	S $\pm .003$	M Max.	H Nom.	Anvil Hole Dia. +.003 -.000	
			.188	.250	.312	.375	.437	.500	.562	.625	.750	.875								1.00
			6	8	10	12	14	16	18	20	24	28								32
CFSKC	6060		-6	-8	-10	-12	-14	-16	-18	-20	-24	-28	-32	.099	.177	.212	.068	.108	.250	.216

### Dimensions & Specifications

METRIC (mm)	Series	Body/ Hole Code	L Length $\pm .13$ mm.										A $\pm .08$	B $\pm .08$	C Max.	S $\pm .08$	M Max.	H Nom.	Anvil Hole Dia. +.08 -.00
			6	8	10	12	14	16	18	20	22	25							
			6	8	10	12	14	16	18	20	22	25							
CFSKC	61.5		-6	-8	-10	-12	-14	-16	-18	-20	-22	-25	2.51	4.5	5.39	1.73	2.75	6.35	5.5

† Not stocked, available on special order.

### Installation & Performance Data

INCH (in.)	Body Size/ Hole Code	.060 in. (1.52mm) 5052-H34 Aluminum		.060 in. (1.52mm) Cold-rolled Steel	
		Installation (lbs.)	Pushout (lbs.)	Installation (lbs.)	Pushout (lbs.)
		6060	1600	250	3200
METRIC (mm)	61.5	(kN)	(N)	(kN)	(N)
	61.5	7.1	1100	14.2	2600

Continued on next page.

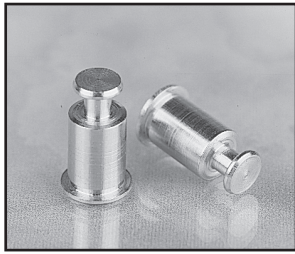

# Self-Clinching Slide-Top Standoffs

## Series CFSKC

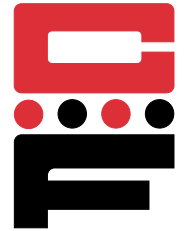

Continued from previous page.

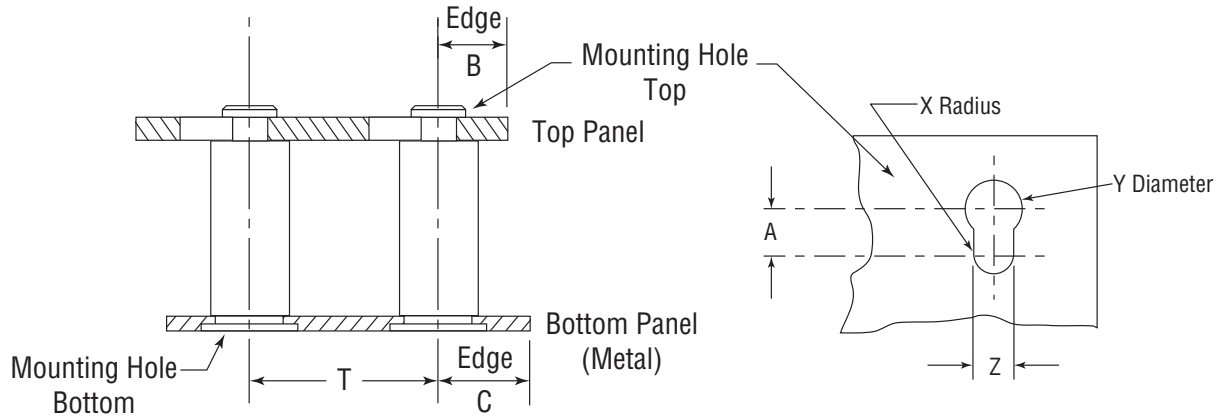

### Installation & Performance Data

INCH (in.)	Bottom Panel					Top Panel						
	Bottom Mounting Hole +.003 -.000	Min.	C Min.	Location Tolerance T Max.	Tolerance	Top Mounting Hole				Material	Thickness Range	B Min.
						X Nom.	Y ±.003	Z ±.003	A Min.			
CFSKC	.213	.040	.260	±.005		.059	.197	.118	.148	PC Board or Metal	.057 - .064	.160

### Installation & Performance Data

METRIC (mm)	Bottom Panel					Top Panel						
	Bottom Mounting Hole +.08 -.00	Min.	C Min.	Location Tolerance T Max.	Tolerance	Top Mounting Hole				Material	Thickness Range	B Min.
						X Nom.	Y ±.08	Z ±.08	A Min.			
CFSKC	5.41	1.02	6.6	±.13		1.5	5.0	3.0	3.75	PC Board or Metal	1.45 - 1.62	4.1

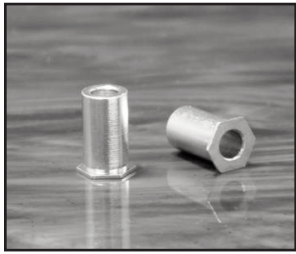

# Self-Clinching Unthreaded Thru-Hole Standoffs

## Series CFSO, CFSOS & CFSOA

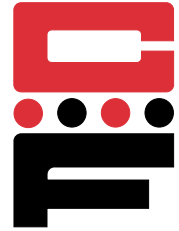

CFSO self-clinching standoffs are designed for quick, simple installation with any standard press into a drilled or punched hole, and become permanently attached to the thin sheet metal material. They are primarily used to provide spacing of multi-panel assemblies. The unthreaded hole allows threaded studs to pass directly through the spacer to lower areas.

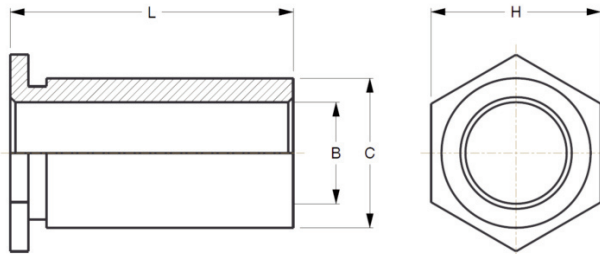

Series	Material	Finish
CFSO	Heat-treated Carbon Steel	Zinc* Clear
CFSOS	300 Series Stainless Steel	Passivated ASTM A967
CFSOA	7075-T6 Aluminum	None

\*See Finish Spec. on Page 6.

Use in: CFSO for materials with Rockwell Hardness of B-80 or less.

CFSOS for materials with Rockwell Hardness of B-70 or less.

CFSOA for materials with Rockwell Hardness of B-50 or less.

Part Number Structure:

CFSO 4116-4

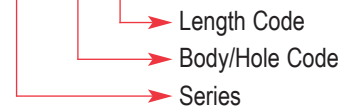

All Measurements In Inches.

### Dimensions & Specifications

B +.004 -.003 Thru-Hole Diameter	Part Number	L Length +.002 -.005 in.											C +.003 -.000	H +.000 -.005	Hex Dim.	Min.	Min.
		.125	.187	.250	.312	.375	.437	.500	.562	.625	.687	.750					
.116	CFSO 4116	-4	-6	-8	-10	-12	-14	-16	-18	-20	-22	-24	.166	.165	.187	.23	.040
	CFSOS 4116	-4	-6	-8	-10	-12	-14	-16	-18	-20	-22	-24					
	CFSOA 4116	-4	-6	-8	-10	-12	-14	-16	-18	-20	-22	-24					
.116	CFSO 6116	-4	-6	-8	-10	-12	-14	-16	-18	-20	-22	-24	.213	.212	.250	.27	.040
	CFSOS 6116	-4	-6	-8	-10	-12	-14	-16	-18	-20	-22	-24					
	CFSOA 6116	-4	-6	-8	-10	-12	-14	-16	-18	-20	-22	-24					
.143	CFSO 6143	-4	-6	-8	-10	-12	-14	-16	-18	-20	-22	-24	.213	.212	.250	.27	.040
	CFSOS 6143	-4	-6	-8	-10	-12	-14	-16	-18	-20	-22	-24					
	CFSOA 6143	-4	-6	-8	-10	-12	-14	-16	-18	-20	-22	-24					
.143	CFSO 8143	-4	-6	-8	-10	-12	-14	-16	-18	-20	-22	-24	.281	.280	.312	.31	.050
	CFSOS 8143	-4	-6	-8	-10	-12	-14	-16	-18	-20	-22	-24					
	CFSOA 8143	-4	-6	-8	-10	-12	-14	-16	-18	-20	-22	-24					
.169	CFSO 8169	-4	-6	-8	-10	-12	-14	-16	-18	-20	-22	-24	.281	.280	.312	.31	.050
	CFSOS 8169	-4	-6	-8	-10	-12	-14	-16	-18	-20	-22	-24					
	CFSOA 8169	-4	-6	-8	-10	-12	-14	-16	-18	-20	-22	-24					
.194	CFSO 8194	-4	-6	-8	-10	-12	-14	-16	-18	-20	-22	-24	.281	.280	.312	.31	.050
	CFSOS 8194	-4	-6	-8	-10	-12	-14	-16	-18	-20	-22	-24					
	CFSOA 8194	-4	-6	-8	-10	-12	-14	-16	-18	-20	-22	-24					

Continued on next page.



# Self-Clinching Unthreaded Thru-Hole Standoffs

## Series CFSO, CFSOS & CFSOA

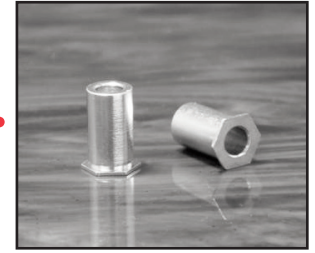

Continued from previous page.

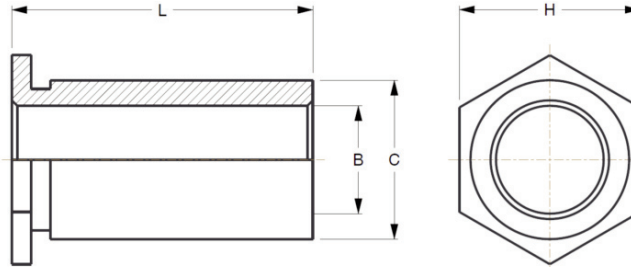

All Measurements In Millimeters.

### Dimensions & Specifications

B +.10 -.08 Thru-Hole Diameter	Part Number	L Length +.05 -.13 mm										+08 -.00	C +.00 -.13	H Hex Dim.	Min.	Min.
		3	4	6	8	10	12	14	16	18	20					
3.1	CFSO	-3	-4	-6	-8	-10	-12	-14	-16	-18	-20	4.22	4.19	4.8	6	1.02
	CFSOS 43.1	-3	-4	-6	-8	-10	-12	-14	-16	-18	-20					
	CFSOA	-3	-4	-6	-8	-10	-12	-14	-16	-18	-20					
3.1	CFSO	-3	-4	-6	-8	-10	-12	-14	-16	-18	-20	5.41	5.38	6.4	6.8	1.02
	CFSOS 63.1	-3	-4	-6	-8	-10	-12	-14	-16	-18	-20					
	CFSOA	-3	-4	-6	-8	-10	-12	-14	-16	-18	-20					
3.6	CFSO	-3	-4	-6	-8	-10	-12	-14	-16	-18	-20	5.41	5.38	6.4	6.8	1.02
	CFSOS 63.6	-3	-4	-6	-8	-10	-12	-14	-16	-18	-20					
	CFSOA	-3	-4	-6	-8	-10	-12	-14	-16	-18	-20					
3.6	CFSO	-3	-4	-6	-8	-10	-12	-14	-16	-18	-20	7.14	7.11	7.9	8	1.27
	CFSOS 83.6	-3	-4	-6	-8	-10	-12	-14	-16	-18	-20					
	CFSOA	-3	-4	-6	-8	-10	-12	-14	-16	-18	-20					
4.1	CFSO	-3	-4	-6	-8	-10	-12	-14	-16	-18	-20	7.14	7.11	7.9	8	1.27
	CFSOS 84.1	-3	-4	-6	-8	-10	-12	-14	-16	-18	-20					
	CFSOA	-3	-4	-6	-8	-10	-12	-14	-16	-18	-20					
5.1	CFSO	-3	-4	-6	-8	-10	-12	-14	-16	-18	-20	7.14	7.11	7.9	8	1.27
	CFSOS 85.1	-3	-4	-6	-8	-10	-12	-14	-16	-18	-20					
	CFSOA	-3	-4	-6	-8	-10	-12	-14	-16	-18	-20					

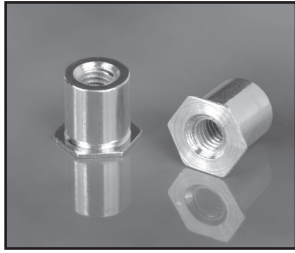

# Self Clinching Standoffs For Thin Sheet Material

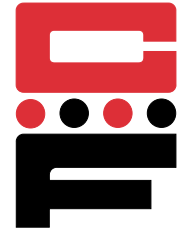

## Series CFT, CFTS & CFTA

CFT standoffs allow flush-head installation in a material thickness of .025in.(.63mm) or more

Series	Material	Finish
CFT	Heat-treated Carbon Steel	Zinc* Clear
CFTS	300 Series Stainless Steel	Passivated ASTM A967
CFTA	7075-T6 Aluminum	None

\*See Finish Spec on Page 6.

Thread: Internal 2B, ANSI B1.1

Use in : CFT- Material with HR of B-60 or less

CFTS- Material with HR of B-70 or less

CFTA- Material with HR of B-50 or less

Part Number Structure:

CFT 440-.090

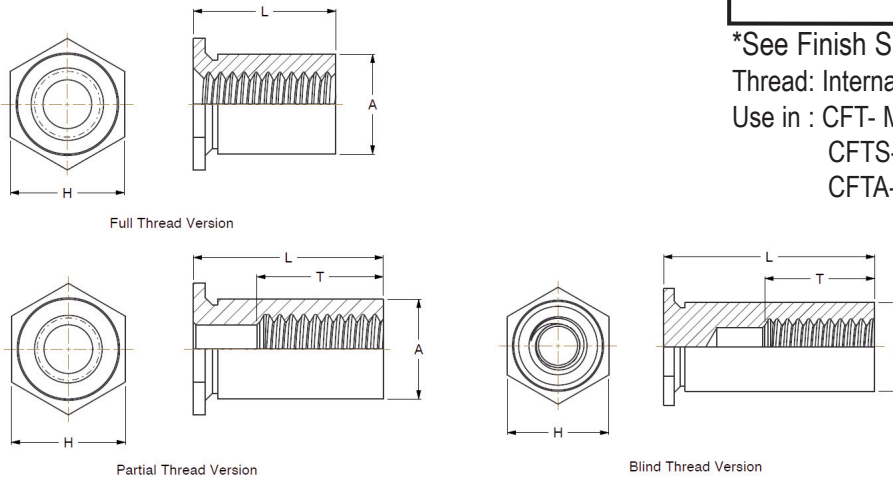

### Dimensions & Specifications

INCH (in.)	Thread Size	Part Number	L Length ±.003 in.											+.003 -.000	A +.000 -.005	H Nom.	T Min.	Min.	Min.	
			0.09	0.125	0.187	0.25	0.312	0.375	0.437	0.5	0.562	0.625	0.687							0.75
#2-56	CFT	256	-0.09	-0.125	-0.187	-0.25	-0.312	-0.375	-0.437	-0.5	-0.562	-0.625	-0.687	-0.75	0.166	0.165	0.187	0.2	0.23	0.025
	CFTS	256	-0.09	-0.125	-0.187	-0.25	-0.312	-0.375	-0.437	-0.5	-0.562	-0.625	-0.687	-0.75						
	CFTA	256	-0.09	-0.125	-0.187	-0.25	-0.312	-0.375	-0.437	-0.5	-0.562	-0.625	-0.687	-0.75						
	CFT	6256	-0.09	-0.125	-0.187	-0.25	-0.312	-0.375	-0.437	-0.5	-0.562	-0.625	-0.687	-0.75	0.213	0.212	0.25	0.27	0.025	
	CFTS	6256	-0.09	-0.125	-0.187	-0.25	-0.312	-0.375	-0.437	-0.5	-0.562	-0.625	-0.687	-0.75						
	CFTA	6256	-0.09	-0.125	-0.187	-0.25	-0.312	-0.375	-0.437	-0.5	-0.562	-0.625	-0.687	-0.75						
#4-40	CFT	440	-0.09	-0.125	-0.187	-0.25	-0.312	-0.375	-0.437	-0.5	-0.562	-0.625	-0.687	-0.75	0.166	0.165	0.187	0.22	0.23	0.025
	CFTS	440	-0.09	-0.125	-0.187	-0.25	-0.312	-0.375	-0.437	-0.5	-0.562	-0.625	-0.687	-0.75						
	CFTA	440	-0.09	-0.125	-0.187	-0.25	-0.312	-0.375	-0.437	-0.5	-0.562	-0.625	-0.687	-0.75						
	CFT	6440	-0.09	-0.125	-0.187	-0.25	-0.312	-0.375	-0.437	-0.5	-0.562	-0.625	-0.687	-0.75	0.213	0.212	0.25	0.27	0.025	
	CFTS	6440	-0.09	-0.125	-0.187	-0.25	-0.312	-0.375	-0.437	-0.5	-0.562	-0.625	-0.687	-0.75						
	CFTA	6440	-0.09	-0.125	-0.187	-0.25	-0.312	-0.375	-0.437	-0.5	-0.562	-0.625	-0.687	-0.75						
#6-32	CFT	632		-0.125	-0.187	-0.25	-0.312	-0.375	-0.437	-0.5	-0.562	-0.625	-0.687	-0.75	0.213	0.212	0.25	0.27	0.27	0.025
	CFTS	632		-0.125	-0.187	-0.25	-0.312	-0.375	-0.437	-0.5	-0.562	-0.625	-0.687	-0.75						
	CFTA	632		-0.125	-0.187	-0.25	-0.312	-0.375	-0.437	-0.5	-0.562	-0.625	-0.687	-0.75						
Version			Full Thread				Partial Thread				Blind Thread				Note: Items may be subject to minimum order					

Continued on next page.





# Self-Clinching Standoffs For Thin Sheet Material

## Series CFT, CFTS & CFTA



Continued from previous page.

CFT standoffs allow flush-head installation in a material thickness of .025in.(.63mm) or more

Series	Material	Finish
CFT	Heat-treated Carbon Steel	Zinc* Clear
CFTS	300 Series Stainless Steel	Passivated ASTM A967
CFTA	7075-T6 Aluminum	None

\*See Finish Spec on Page 6.

Thread: Internal 2B, ANSI B1.1

Use in : CFT- Material with HR of B-60 or less

CFTS- Material with HR of B-70 or less

CFTA- Material with HR of B-50 or less

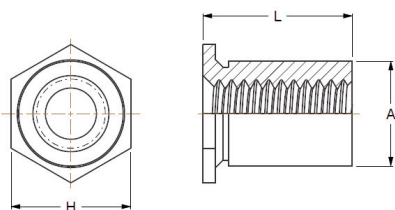

Full Thread Version

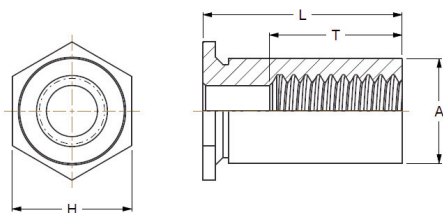

Partial Thread Version

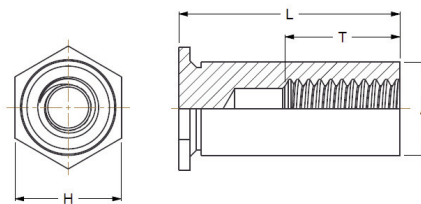

Blind Thread Version

Part Number Structure:

CFT M2.5- 200

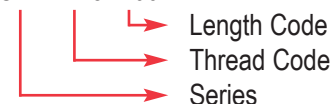

### Dimensions & Specifications

METRIC (mm.)	Thread Size	Part Number	L Length $\pm 0.08$ mm.										+0.8 -0.00	A +0.00 -.13	H Nom.	T Min.	Min.	Min.	
			2.00	3.00	4.00	6.00	8.00	10.00	12.00	14.00	16.00	18.00							19.00
M2.5x0.45	CFT	M2.5	-200	-300	-400	-600	-800	-1000	-1200	-1400	-1600	-1800	-1900	4.22	4.2	4.8	5.2	5.8	0.63
	CFTS	M2.5	-200	-300	-400	-600	-800	-1000	-1200	-1400	-1600	-1800	-1900						
	CFTA	M2.5	-200	-300	-400	-600	-800	-1000	-1200	-1400	-1600	-1800	-1900						
	CFT	6M2.5	-200	-300	-400	-600	-800	-1000	-1200	-1400	-1600	-1800	-1900	5.41	5.39	6.4	7.1	0.63	
	CFTS	6M2.5	-200	-300	-400	-600	-800	-1000	-1200	-1400	-1600	-1800	-1900						
	CFTA	6M2.5	-200	-300	-400	-600	-800	-1000	-1200	-1400	-1600	-1800	-1900						
M3x0.5	CFT	M3	-200	-300	-400	-600	-800	-1000	-1200	-1400	-1600	-1800	-1900	4.22	4.2	4.8	6.2	5.8	0.63
	CFTS	M3	-200	-300	-400	-600	-800	-1000	-1200	-1400	-1600	-1800	-1900						
	CFTA	M3	-200	-300	-400	-600	-800	-1000	-1200	-1400	-1600	-1800	-1900						
	CFT	6M3	-200	-300	-400	-600	-800	-1000	-1200	-1400	-1600	-1800	-1900	5.41	5.39	6.4	7.1	0.63	
	CFTS	6M3	-200	-300	-400	-600	-800	-1000	-1200	-1400	-1600	-1800	-1900						
	CFTA	6M3	-200	-300	-400	-600	-800	-1000	-1200	-1400	-1600	-1800	-1900						
M3.5x0.6	CFT	M3.5		-300	-400	-600	-800	-1000	-1200	-1400	-1600	-1800	-1900	5.41	5.39	6.4	7	7.1	0.63
	CFTS	M3.5		-300	-400	-600	-800	-1000	-1200	-1400	-1600	-1800	-1900						
	CFTA	M3.5		-300	-400	-600	-800	-1000	-1200	-1400	-1600	-1800	-1900						
Version			Full Thread				Partial Thread			Blind Thread			Note: Items may be subject to minimum order						

Continued on next page.

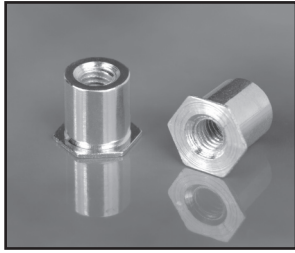

# Self-Clinching Standoffs For Thin Sheet Material

## Series CFT, CFTS & CFTA

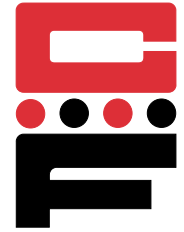

Continued from previous

### Installation & Performance Data

A Dim.	Series	Sheet Material											
		.025 in. (.64mm) 5052-H-34 Aluminum						.025 in. (.64mm) Cold-Rolled Steel					
		Installation		Pushout		Torque-out		Installation		Pushout		Torque-out	
		lbs.	kN	lbs.	N	in-lbs.	N•m	lbs.	kN	lbs.	N	in-lbs.	N•m
.165 in. (4.2 mm)	CFT	1500	6.7	70	311	6	0.68	2000	8.9	100	445	9	1
	CFTS							-	-	-	-	-	-
	CFTA							-	-	-	-	-	-
.212 in. (5.39mm)	CFT	1800	8	90	400	11	1.24	2500	11.1	150	667	15	1.7
	CFTS							-	-	-	-	-	-
	CFTA							-	-	-	-	-	-

The installation and performance data listed are nominal when all specifications are adhered to. Changes in sheet hardness and mounting hole tolerance will affect performance. Therefore, we recommend testing the product in your application to determine actual results. Samples are available upon request.

### Installation

1. Prepare the required size hole in the base material by punching or drilling. Do not deburr hole.
2. Place standoff through hole in material and into installation anvil and squeeze into place using a shop press with flat punch
3. Apply a sufficient force to seat the hex head flush into the base material.
4. Use chamfered anvil shown for sheet thickness of .025 to .032 in. (.63 to .81 mm) for sheets over .032 (.81 mm) The special anvil is not required.

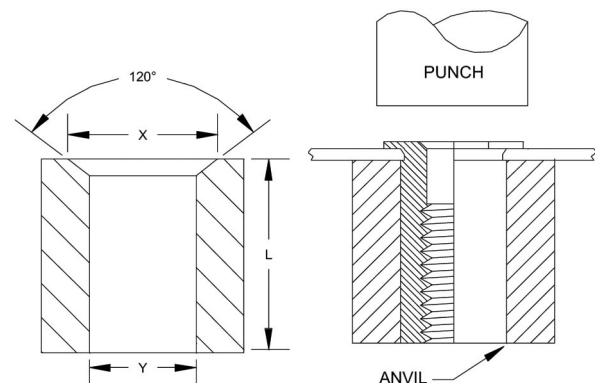

Standoff A Dimension	Anvil Dimensions			
	Y		X	
	Inches	mm	Inches	mm
.165 in./4.2mm	.167 - .170	4.24 - 4.32	.187 - .194	4.75 - 4.93
.212 in./5.39mm	.213 - .216	5.41 - 5.49	.250 - .257	6.35 - 6.53



# Self-Clinching Spring-Top Standoffs

## Series CFSSA, CFSSS & CFSSC



CFSSA, CFSSS & CFSSC spring-top standoffs are designed for permanent installation into sheet metal by pressing into a prepared hole. The spring-action post provides quick attachment and removal with a simple snap eliminating the problems associated with loose hardware.

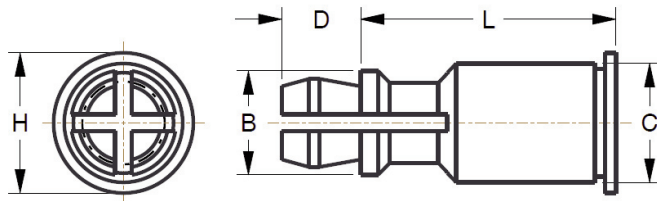

Series	Material	Finish
CFSSA	7075-T6 Aluminum	Plain
CFSSS	Carbon Steel	Zinc* Clear
CFSSC	400 Series Stainless Steel	Passivated ASTM A967

\*See Finish Spec. on Page 6.

Use in: CFSSA – Cold-rolled Steel HRB-50 or less.  
 CFSSS – Cold-rolled Steel HRB-60 or less.  
 CFSSC – Cold-rolled Steel HRB-70 or less.

Part Number Structure:

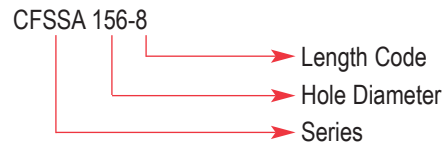

### Dimensions & Specifications

INCH (in.)	Series	Top Panel Mounting Hole Diameter Code	L Length $\pm .005$ in. (Length Code in 32nds of an inch)										B $\pm .005$	C Max.	D $\pm .005$	H $\pm .005$
			.250	.312	.375	.437	.500	.562	.625	.750	.875	1.000				
	CFSSA	156	-8	-10	-12	-14	-16	-18	-20	-24	-28	-32	.188	.212	.141	.250
	CFSSC	156	-8	-10	-12	-14	-16	-18	-20	-24	-28	-32				
	CFSSS	156	-8	-10	-12	-14	-16	-18	-20	-24	-28	-32				

### Dimensions & Specifications

METRIC (mm)	Series	Top Panel Mounting Hole Diameter Code	L Length $\pm .13$ mm (Length Code is in millimeters)								B $\pm .13$	C Max.	D $\pm .13$	H $\pm .13$	
			8	10	12	14	16	18	20	22					25
	CFSSA	4MM	-8	-10	-12	-14	-16	-18	-20	-22	-25	4.78	5.39	3.58	6.35
	CFSSC	4MM	-8	-10	-12	-14	-16	-18	-20	-22	-25				
	CFSSS	4MM	-8	-10	-12	-14	-16	-18	-20	-22	-25				

Continued on next page.



# Self-Clinching Spring Top Standoffs

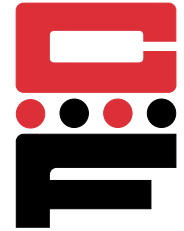

## Series CFSSA, CFSSS & CFSSC

Continued from previous page.

### Installation & Performance Data

INCH (in.)	Series	Bottom Panel (Fixed)					Top Panel (Removable)			
		Bottom Mounting Hole +.003 -.000	Material	Hardness Max.	Thickness Min.	Location Tolerance Min.	Top Mounting Hole +.003 -.000	Material	Thickness Range	Min.
CFSSA	.213	Metal	HRB50	.040	.260	±.005	.156	P-C board or metal	.040-.070	.100
CFSSS	.213		HRB60	.040	.260	±.005	.156		.100	
CFSSC	.213		HRB70	.040	.260	±.005	.156		.100	

### Installation & Performance Data

INCH (in.)	Series	Bottom Panel (Fixed)			Top Panel (Removable)		
		Sheet Thickness & Sheet Material	Installation (lbs.)	Pushout (lbs.)	Max. first on force (lbs.)	Min. first off force (lbs.)	Min. 15th off force (lbs.)
CFSSA	.040 Aluminum HRB 25	1500	200	13	3.0	1.0	
CFSSS	.040 Aluminum HRB 25	1500	200	20	6.0	2.0	
CFSSC	.060 Cold-rolled Steel HRB 64	3600	400	20	6.0	2.0	

### Installation & Performance Data

METRIC (mm)	Series	Bottom Panel (Fixed)					Top Panel (Removable)			
		Bottom Mounting Hole +.08 -.00	Material	Hardness Max.	Thickness Min.	Location Tolerance Min.	Top Mounting Hole +.08 -.00	Material	Thickness Range	Min.
CFSSA	5.41	Metal	HRB50	1	6.6	±.134	4.0	P-C board or metal	1-1.8	2.54
CFSSS	5.41		HRB60	1	6.6	±.134	4.0		2.54	
CFSSC	5.41		HRB70	1	6.6	±.134	4.0		2.54	

### Installation & Performance Data

METRIC (mm)	Series	Bottom Panel (Fixed)			Top Panel (Removable)		
		Sheet Thickness & Sheet Material	Installation (kN)	Pushout (N)	Max. first on force (N)	Min. first off force (N)	Min. 15th off force (N)
CFSSA	1.0 Aluminum HRB 25	6.7	880	58	13	4.0	
CFSSS	1.0 Aluminum HRB 25	6.7	880	89	27	9.0	
CFSSC	1.52 Cold-rolled Steel HRB 64	15.5	1780	89	27	9.0	

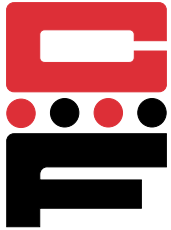

# Self-Clinching Concealed-Head Standoffs

## Series CFHS



CFHS concealed head standoffs allow permanent mounting in thin metal sheets, using a hollow punch and solid anvil. The standoff is pressed permanently into a blind milled hole, with no marring of the exterior surface.

Series	Material	Finish
CFHS	300 Series Stainless Steel	Passivated ASTM A967

Thread: Internal 2B, ANSI B1.1 (6H ANSI/ASME B1.13M)

Use in: Materials with HRB-70 or less.

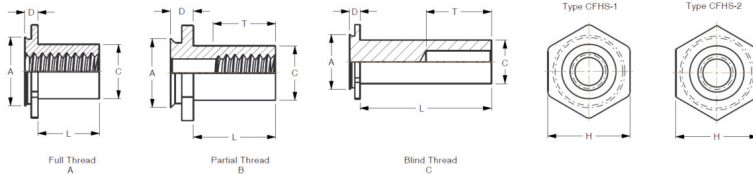

Part Number Structure:

CFHS-1-440-4

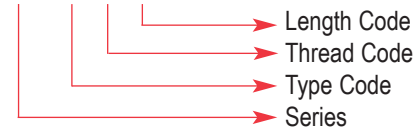

### Dimensions & Specifications

	Thread Size	Type Code	Thread Code	L Length +.002 -.005 (in.)							Min. Sheet Thickness	Blind Mounting Hole Dia. +.003 -.000	Min. Depth Of Blind Hole	T Min. Depth Full Thread	D Max.	C Max.	A Max.	H Nom.	Min. Dist. Hole C/L To Edge	
				.187	.250	.312	.375	.500	.625	.750										1.00
INCH (in.)	.112-40 (#4-40)	CFHS-1	440	3 <sup>A</sup>	4 <sup>B</sup>	5 <sup>B</sup>	6 <sup>B</sup>	8 <sup>C</sup>	10 <sup>C</sup>	12 <sup>C</sup>	16 <sup>C</sup>	.062	.213	.043	.188	.041	.165	.212	.250	.188
		CFHS-2		.093	.075	.072														
	.138-32 (#6-32)	CFHS-1	632	3 <sup>A</sup>	4 <sup>A</sup>	5 <sup>B</sup>	6 <sup>B</sup>	8 <sup>C</sup>	10 <sup>C</sup>	12 <sup>C</sup>	16 <sup>C</sup>	.062	.290	.043	.250	.041	.213	.289	.312	.219
		CFHS-2		.093	.075	.072														
	.164-32 (#8-32)	CFHS-1	832 <sup>†</sup>	3 <sup>A</sup>	4 <sup>A</sup>	5 <sup>B</sup>	6 <sup>B</sup>	8 <sup>C</sup>	10 <sup>C</sup>	12 <sup>C</sup>	16 <sup>C</sup>	.062	.312	.043	.250	.041	.245	.311	.344	.250
		CFHS-2		.093	.075	.072														
.190-32 (#10-32)	CFHS-1	1032 <sup>†</sup>	3 <sup>A</sup>	4 <sup>A</sup>	5 <sup>A</sup>	6 <sup>A</sup>	8 <sup>B</sup>	10 <sup>C</sup>	12 <sup>C</sup>	16 <sup>C</sup>	.062	.344	.043	.375	.041	.290	.343	.375	.281	
	CFHS-2		.093	.075	.072															
.250-20 (1/4-20)	CFHS-2	420 <sup>†</sup>	3 <sup>A</sup>	4 <sup>A</sup>	5 <sup>A</sup>	6 <sup>A</sup>	8 <sup>B</sup>	10 <sup>B</sup>	12 <sup>C</sup>	16 <sup>C</sup>	.093	.390	.075	.375	.072	.354	.389	.438	.375	
	Thread Size	Type Code	Thread Code	L Length +.05 -.13 (mm)							Min. Sheet Thickness	Blind Mounting Hole Dia. +.08 -.00	Min. Depth Of Blind Hole	T Min. Depth Full Thread	D Max.	C Max.	A Max.	H Nom.	Min. Dist. Hole C/L To Edge	
				4	6	8	10	12	16	20										25
METRIC (mm)	M3x0.5	CFHS-1	M3	4 <sup>A</sup>	6 <sup>A</sup>	8 <sup>B</sup>	10 <sup>C</sup>	12 <sup>C</sup>	16 <sup>C</sup>	20 <sup>C</sup>	25 <sup>C</sup>	1.6	5.41	1.1	5	1.04	4.2	5.39	6.35	4.8
		CFHS-2		2.4	1.91	1.83														
	M4x0.7	CFHS-1	M4	4 <sup>A</sup>	6 <sup>A</sup>	8 <sup>B</sup>	10 <sup>B</sup>	12 <sup>C</sup>	16 <sup>C</sup>	20 <sup>C</sup>	25 <sup>C</sup>	1.6	7.92	1.1	6.5	1.04	6.23	7.9	8.74	6.4
		CFHS-2		2.4	1.91	1.83														
	M5x0.8	CFHS-1	M5 <sup>†</sup>	4 <sup>A</sup>	6 <sup>A</sup>	8 <sup>B</sup>	10 <sup>B</sup>	12 <sup>B</sup>	16 <sup>C</sup>	20 <sup>C</sup>	25 <sup>C</sup>	1.6	8.74	1.1	9.6	1.04	7.37	8.72	9.53	7.2
		CFHS-2		2.4	1.91	1.83														
	M6x1	CFHS-2	M6 <sup>†</sup>	4 <sup>A</sup>	6 <sup>A</sup>	8 <sup>A</sup>	10 <sup>B</sup>	12 <sup>B</sup>	16 <sup>C</sup>	20 <sup>C</sup>	25 <sup>C</sup>	2.4	9.9	1.91	9.6	1.83	9	9.89	11.11	9.5

<sup>†</sup>Not stocked, available on special order.

Continued on next page.

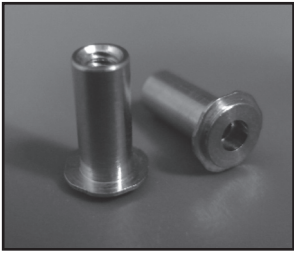

# Self-Clinching Concealed-Head Standoffs

## Series CFHS

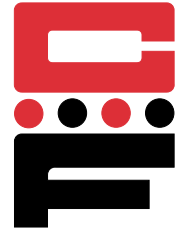

Continued from previous page.

### Installation & Performance Data

	Type Code	Thread Code	Tightening Torque Max (in.-lbs.)	Test Sheet Material			
				Cold-rolled Steel		5052-H34 Aluminum	
				Installation Force (lbs.)	Pullout (lbs.)	Installation Force (lbs.)	Pullout (lbs.)
INCH (in.)	CFHS-1	440	4.75	4000	300	2800	200
		632	8.75	4500	350	3000	240
		832	18	4800	400	4000	270
		1032	32	5500	450	5000	290
	CFHS-2	440	4.75	4300	330	2900	220
		632	8.75	5000	360	3200	240
		832	18	5300	440	4000	300
		1032	32	6000	600	5000	400
		420	64	6500	650	5500	430

### Installation & Performance Data

	Type Code	Thread Code	Tightening Torque Max (N•m)	Test Sheet Material			
				Cold-rolled Steel		5052-H34 Aluminum	
				Installation Force (kN)	Pullout (N)	Installation Force (kN)	Pullout (N)
METRIC (mm)	CFHS-1	M3	.55	17.8	1330	12.5	890
		M4	2	21.3	1775	17.8	1200
		M5	3.6	24.5	2000	22.2	1290
	CFHS-2	M3	.55	19.2	1465	12.9	975
		M4	2	23.6	1955	17.8	1335
		M5	3.6	26.7	2665	22.2	1775
		M6	7.2	28.9	2860	24.4	1915



# Self-Clinching Concealed-Head Standoffs

## Series CFHS

### Typical Installation Method



Continued from previous page.

#### Installation Procedure

1. Mill a blind hole in material to specified depth.
2. Place fastener into hole in anvil.
3. Place sheet material over head of fastener.
4. Apply a downward squeezing force with punch, pressing on sheet material until serrated collar of fastener is flush with surface.

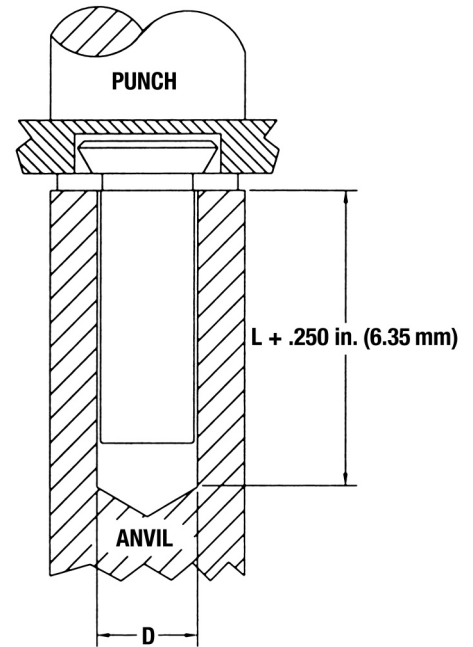

\*Depth of blind holes may be greater than minimum, if sheet thickness allows.

#### Anvil 'D' Diameter Dimensions for Concealed Head Studs

	Series	Thread Code	D Dia. (in.)
INCH (in.)	CFHS	440	.170
		632	.218
		832	.250
		1032	.295
		420	.358

	Series	Thread Code	D Dia. (mm)
METRIC (mm)	CFHS	M3	4.33
		M4	6.36
		M5	7.5
		M6	9.13



# Weld Nuts

## Series CFWN & CFWNS

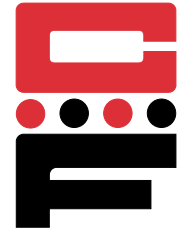

CFWN weld nuts are the solution to providing load bearing threads in sheets that are too thin to tap. They provide three-point projections for fast, easy welding. Captive Fastener weld nuts self align into standard hole sizes, and are dimensionally identical to industry standards. The alignment collar orients the weld nut and prevents weld spatter from entering thread area.

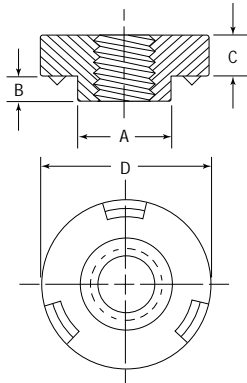

Series	Material	Finish
CFWN	Carbon Steel	Light Oil Coat (Copper Flash Optional)
CFWNS	300 Series Stainless Steel	Passivated ASTM A967

Thread: Internal 2B, ANSI B1.1 (6H, ANSI/ASME B1.13M).

Part Number Structure:

CFWN 632-1

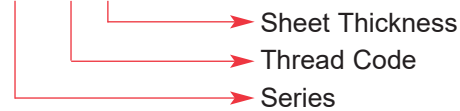

### Dimensions & Specifications

Thread Size	Part Number		Min.	+.004 in. (+.10 mm) -.000(.00)	A Max	B Max	C ±.004 in.(±.10 mm)	D +.000 in. (+.00 mm) -.010 in. (-.25 mm)	Min.
	Carbon Steel	Stainless Steel							
INCH (in.)	#4-40	CFWN440 CFWNS440	.030	.173	.173	.030	.065	.308	.154
	#6-32	CFWN632 CFWNS632	.030	.193	.192	.030	.094	.341	.171
		CFWN632-1	N/A	.060	.193	.192			
	#8-32	CFWN832 CFWNS832	.030	.218	.217	.030	.108	.371	.186
		CFWN832-1	N/A	.060	.218	.217			
	#10-24	CFWN1024 CFWNS1024	.030	.250	.249	.030	.156	.440	.220
		CFWN1024-1	N/A	.060	.250	.249			
#10-32	CFWN1032 CFWNS1032	.030	.250	.249	.030	.156	.440	.220	
	CFWN1032-1	N/A	.060	.250	.249				.050
1/4-20	CFWN420 CFWNS420	.048	.316	.315	.048	.186	.522	.261	
METRIC (mm)	M3 x 0.5	CFWNM3 CFWNSM3	.77	4.39	4.36	.77	1.49	7.82	3.91
	M4 x 0.7	CFWNM4 CFWNSM4	.77	5.53	5.5	.77	2.58	9.42	4.71
	M5 x 0.8	CFWNM5 CFWNSM5	.77	6.35	6.32	.77	3.78	11.17	5.59
	M6 x 1.0	CFWNM6 CFWNSM6	1.24	8.04	8.01	1.22	4.56	13.25	6.63

N/A = Not Available

Continued on next page.





# Weld Nuts

## Series CFWN & CFWNS

Continued from previous page.

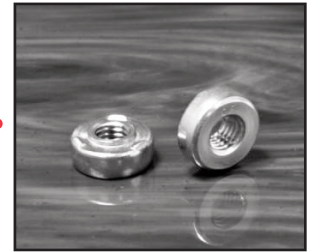

### Performance Data

	Series	Thread Size	Cold-Rolled Steel .060 in. (1.5mm)		300 Series Stainless Steel .060 in. (1.5mm)	
			Pushout (lbs.)	Torque-Out (in.-lbs.)	Pushout (lbs.)	Torque-Out (in.-lbs.)
INCH (in.)	CFWN	#4-40	500	13	N/A	N/A
		#6-32	640	22		
		#8-32	460	33		
		#10-32	880	56		
		1/4-20	1000	185		
	CFWNS	#4-40	N/A	N/A	680	13
		#6-32			800	28
		#8-32			850	45
		#10-32			900	110
		1/4-20			1000	200
METRIC (mm)	CFWN	Thread Size	Pushout (N)	Torque-Out (N*m)	N/A	N/A
		M3	2220	1.4		
		M4	3380	3.7		
		M5	3910	6.3		
		M6	4445	20.9		
	CFWNS	M3	N/A	N/A	3020	1.4
		M4			3780	5
		M5			4000	12.4
		M6			4445	22.5

### Installation Data

	Series	Thread Size	Sheet material .030 in. (.077 mm) to .063 in. (1.6mm)					
			Cold Rolled Steel			300 Series Stainless Steel		
			Electro Ram Force (lbs.)	Secondary Current Amps ±500	Weld Time Cycle/Sec.	Electro Ram Force (lbs.)	Secondary Current Amps ±500	Weld Time Cycle/Sec.
INCH (in.)	CFWN	#4-40	450-500	17,000	6/0.10	N/A	N/A	N/A
		#6-32	450-500	17,000	6/0.10			
		#8-32	450-500	17,000	6/0.10			
		#10-32	500-550	18,000	10/0.17			
		1/4-20	550-600	20,000	10/0.17			
	CFWNS	#4-40	N/A	N/A	N/A	450-500	16,500	6/0.10
		#6-32				450-500	16,500	6/0.10
		#8-32				500-550	16,500	6/0.10
		#10-32				550-600	18,500	6/0.10
		1/4-20				650-700	20,000	6/0.10
METRIC (mm.)	CFWN	Thread Size	Electro Ram Force (lbs.)	Secondary Current Amps ±500	Weld Time Cycle/Sec.	N/A	N/A	N/A
		M3	2000-2200	17,000	6/0.10			
		M4	2000-2200	17,000	6/0.10			
		M5	2220-2440	18,000	10/0.17			
		M6	2440-2670	20,000	10/0.17			
	CFWNS	M3	N/A	N/A	N/A	2000-2220	16,500	6/0.10
		M4				2220-2225	16,500	6/0.10
		M5				2440-2670	18,500	6/0.10
		M6				2890-3110	20,000	6/0.10

#### TECHNIQUES FOR BETTER WELDING

Be sure the electrodes, sheet material and weld nuts themselves are clean and contain no grease, rust, or burrs. If installed welds look good, but pushout performance is poor, check for the following causes:

- Σ Electro force too high
- Σ Low current level
- Σ Dirty panel
- Σ Nuts not centered
- Σ Hold time too short, causing insufficient cooling
- Σ Inconsistent pressure regulator

If threads are distorted after installation, check for the following causes:

- Σ Long weld time
- Σ High current level
- Σ Electrode force too high

#### INSTALLATION TIPS

Electrode force is the pressure applied by electrodes on the weld nut and sheet material to squeeze them together and make good contact.

Low electrode force may cause discoloration, flashing, burning or spatter.

High electrode force may compress weld projections before correct temperature is achieved or push projections of the unheated weld nut into the sheet.

Secondary current setting controls the heat applied to the Captive weld nut and sheet material.

N/A = Not Available

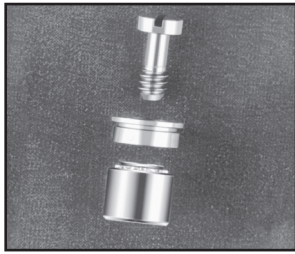

# Flush-Mounted Panel Screw Components

## Series CFS2, CFR2 & CFN2



CFS2, CFR2 & CFN2 Panel Screw Components remain captive to panel and frame when unassembled. Panel Screws are designed to be flush in sheets as thin as .125 in. (3.2 mm.)

Series	Material	Finish
CFS2	300 Series Stainless Steel	Passivated ASTM A967
CFR2	300 Series Stainless Steel	Passivated ASTM A967
CFN2	Heat-treated Carbon Steel	Zinc* Clear

\*See Finish Spec. on Page 6.

Threads:

CFS2 - External 2A, ANSI B1.1 (6g, ANSI/ASME B1.13M)

CFR2 - Internal 2B, ANSI B1.1 (6H, ANSI/ASME B1.13M)

CFN2 - Internal 2B, ANSI B1.1 (6H, ANSI/ASME B1.13M)

Use in: materials of HRB 70 or less.

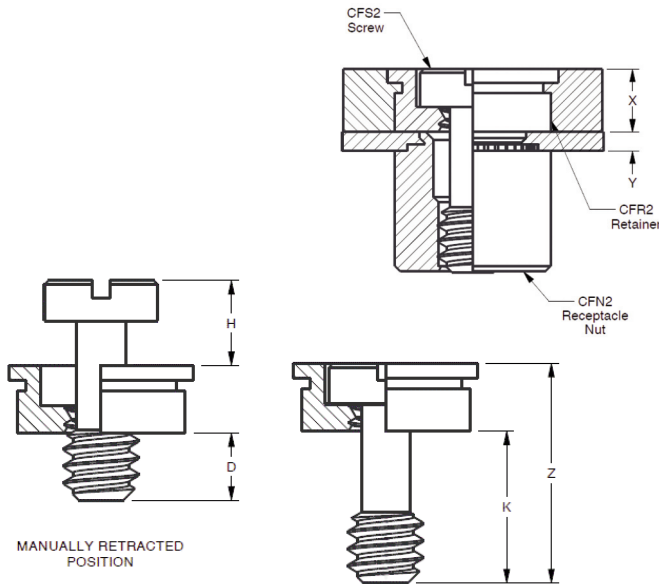

### Dimensions & Specifications

INCH (in.)	Y	X	Z	H	K	D
	Min.	Nom.	$\pm .010$			Nom.
	.04	.125	.40	.16	.28	.13

### Dimensions & Specifications

METRIC (mm)	Y	X	Z	H	K	D
	Min.	Nom.	$\pm .25$			Nom.
	1.0	3.18	10.16	4.06	7.11	3.3

### Alternate Attachment Method:

When thin panel material makes it necessary for the screw head to remain above the top panel surface, CFS2 Screws may be used with CFL Flush Nuts as retainers. CFL nuts self-clinch into sheets as thin as .060 in. (1.5 mm) and remain flush on both sides of the panel. CFS2 Screws are rotated through the threads of the CFL Retainers to install and captivate. Refer to CFL section for dimensions and installation data.

	P Max.	A	B	D Nom.
INCH (in.)				
CFS2 w/CFL Retainer	.060	.075	.210	.130
METRIC (mm)				
CFS2 w/CFL Retainer	1.50	1.90	5.40	3.30

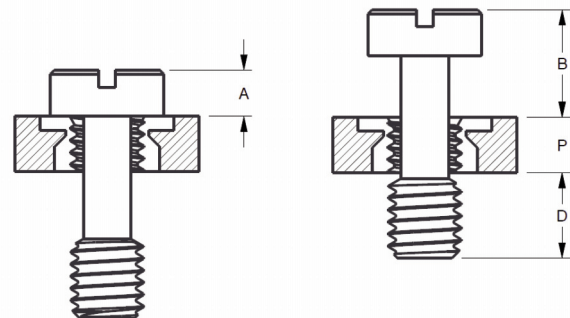

Continued on next page.



# Flush-Mounted Panel Screw Components

## Series CFS2, CFR2 & CFN2

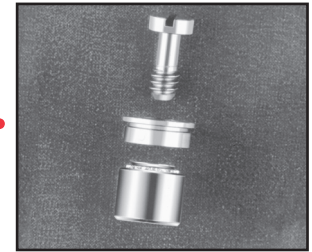

Continued from previous page.

### Series CFS2 Flush-Mounted Screw

Part Number Structure:

CFS2 440-40

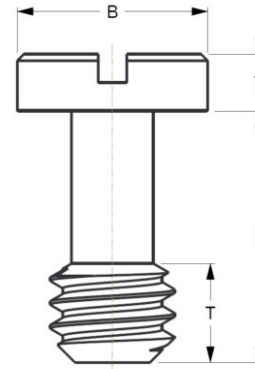
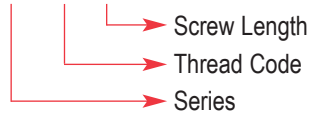

#### Dimensions & Specifications

INCH (in.)		Thread Size	Series	Thread Code	Screw Length Code	B Nom.	Y +.002 -.006	L ±.010	T Nom.
	#4-40	CFS2	440	40	.18	.075	.33	.13	
	#6-32	CFS2	632	40	.21	.075	.33	.13	
	#8-32	CFS2	832	40	.25	.075	.33	.13	
	#10-32	CFS2	1032	40	.28	.075	.33	.13	

#### Dimensions & Specifications

METRIC (mm)		Thread Size	Series	Thread Code	Screw Length Code	B Nom.	Y +.05 -.15	L ±.25	T Nom.
	M3 x 0.5	CFS2	M3	40	4.7	1.91	8.38	3.3	
	M4 x 0.7	CFS2	M4	40	6.3	1.91	8.38	3.3	
	M5 x 0.8	CFS2	M5	40	7.1	1.91	8.38	3.3	

Continued on next page.

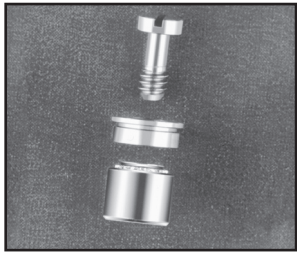

# Flush-Mounted Panel Screw Components

## Series CFS2, CFR2 & CFN2

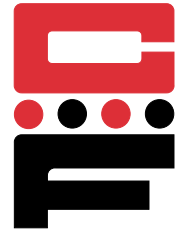

Continued from previous page.

### Series CFR2 Flush-Mounted Retainer

Part Number Structure:

CFR2 440

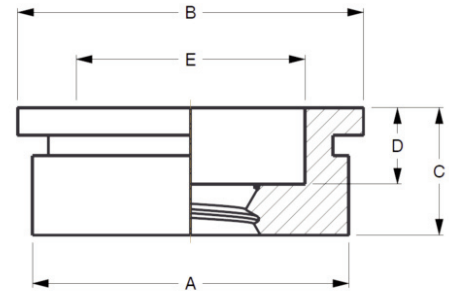
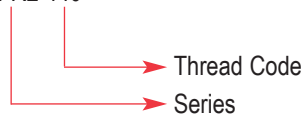

#### Dimensions & Specifications

INCH (in.)												
	Thread Size	Series	Thread Code	C Max.	Min. Self-clinching	Min. Flush Install.	+0.03 -0.00	E Nom.	A Max.	B Nom.	D Nom.	Min.
	#4-40	CFR2	440	.125	.050	.125	.281	.195	.280	.310	.075	.310
	#6-32	CFR2	632	.125	.050	.125	.312	.225	.311	.340	.075	.330
	#8-32	CFR2	832	.125	.050	.125	.344	.255	.343	.370	.075	.340
	#10-32	CFR2	1032	.125	.050	.125	.375	.290	.374	.410	.075	.360

#### Dimensions & Specifications

METRIC (mm)												
	Thread Size	Series	Thread Code	C Max.	Min. Self-clinching	Min. Flush Install.	+0.08 -0.00	E Nom.	A Max.	B Nom.	D Nom.	Min.
	M3 x 0.5	CFR2	M3	3.18	1.27	3.18	7.14	4.75	7.12	7.87	1.91	7.87
	M4 x 0.7	CFR2	M4	3.18	1.27	3.18	8.74	6.48	8.72	9.53	1.91	8.64
	M5 x 0.8	CFR2	M5	3.18	1.27	3.18	9.53	7.37	9.50	10.41	1.91	9.14

Continued on next page.

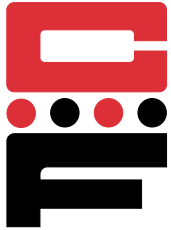

# Flush-Mounted Panel Screw Components

## Series CFS2, CFR2 & CFN2

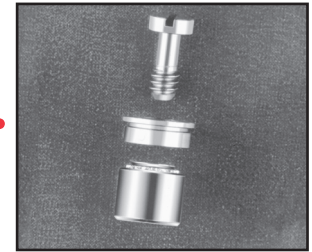

Continued from previous page.

### Series CFN2 Self-Clinching Nut

Part Number Structure:

CFN2 440-1

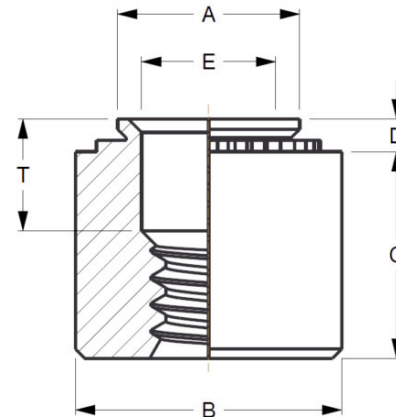
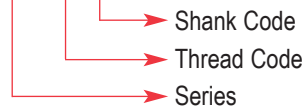

#### Dimensions & Specifications

INCH (in.)		Thread Size	Series	Thread Code	Shank Code	D Max	Min.	+.003 -.000	A Max.	B Nom.	T ±.010	E Nom.	C ±.005	Min.	
		#4-40	CFN2	440	-1	.038	.040	.187	.186	.280	.130	.126	.240	.220	
		#6-32	CFN2	632	-1	.038	.040	.213	.212	.310	.130	.156	.240	.270	
		#8-32	CFN2	832	-1	.038	.040	.250	.249	.340	.130	.187	.240	.280	
		#10-32	CFN2	1032	-1	.038	.040	.277	.276	.370	.130	.213	.240	.310	

#### Dimensions & Specifications

METRIC (mm)		Thread Size	Series	Thread Code	Shank Code	D Max	Min.	+.08 -.00	A Max.	B Nom.	T ±.25	E Nom.	C ±.13	Min.	
		M3 x 0.5	CFN2	M3	-1	.97	1.00	4.75	4.73	7.11	3.30	3.20	6.00	5.59	
		M4 x 0.7	CFN2	M4	-1	.97	1.00	6.33	6.33	8.64	3.30	4.75	6.00	7.11	
		M5 x 0.8	CFN2	M5	-1	.97	1.00	7.01	7.01	9.53	3.30	5.41	6.00	7.87	



# Self-Clinching Spring Loaded Plungers

## Series CPN & CPR

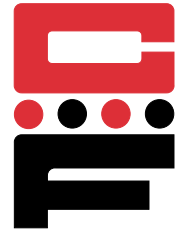

CPN & CPR Spring-Loaded Plunger Assemblies are used as positioning pins and locking stops on drawer slides and equipment consoles. CPR series has a hold open feature activated by pulling out the plunger head and rotating it, which allows smooth slide operation.

Series	Material	Finish	Feature
CPN	Carbon Steel	Bright Nickel over Copper Flash ASTM B689	Spring Return
CPR			Hold Open

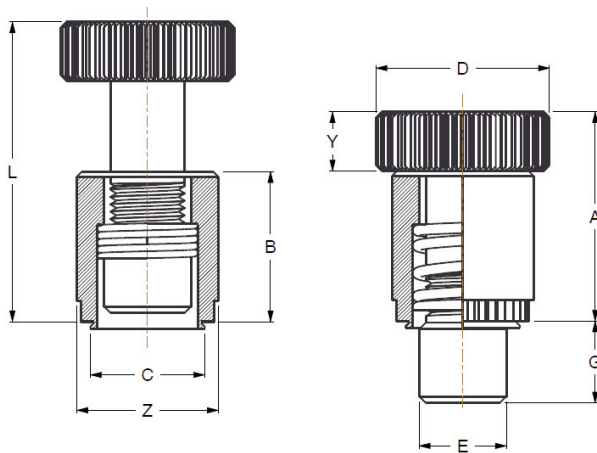

Use in: Cold-rolled Steel or 5052-H34 Aluminum with Rockwell Hardness of HRB-80 or less.

Part Number Structure:

CPN - 04 - 4

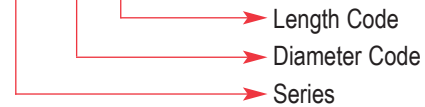

### Dimensions & Specifications

INCH (in.)	Series	Plunger Diameter	Plunger Length	A ±.010	B ±.005	C Max.	D ±.010	E +.000 -.005	G ±.010	L Nom.	Y ±.010	Z ±.010	Min.	+.003 -.000	Min.
	CPR	04	4	.595	.430	.327	.50	.250	.310	.895	.17	.406	.060	.328	.34
CPN*	04	4	.510	.350	.327	.50	.250	.310	.780	.17	.406	.060	.328	.34	

METRIC (mm)	Series	Plunger Diameter	Plunger Length	A ±.25	B ±.13	C Max.	D ±.25	E +.00 -.13	G ±.25	L Nom.	Y ±.25	Z ±.25	Min.	+.08 -.00	Min.
	CPR	04	4	15.11	10.92	8.31	12.7	6.35	7.87	22.73	4.32	10.3	1.53	8.33	8.64
CPN*	04	4	12.95	8.89	8.31	12.7	6.35	7.87	19.81	4.32	10.3	1.53	8.33	8.64	

\*Available on special order.

Continued on next page.









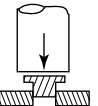

# Self-Clinching Spring Loaded Plungers

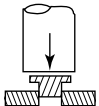
## Series CPN & CPR

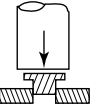

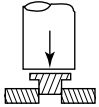
Continued from previous page.

INCH (in.)	Series	Cold Rolled Steel		Aluminum	
		 Installation Force (lbs.)	 Pushout (lbs.)	 Installation Force (lbs.)	 Pushout (lbs.)
	CPN CPR	4000	500	3000	4000
METRIC (mm)	Series	 Installation Force (lbs.)	 Pushout (lbs.)	 Installation Force (lbs.)	 Pushout (lbs.)
	CPN CPR	17.8	2224	13.3	1779

# Recommended Installation Procedure

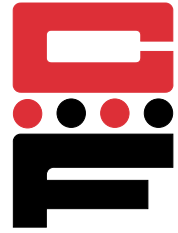

To achieve the correct installation results for **Captive** self-clinching fasteners, please follow the 11 simple rules listed below:

## DO:

1. Provide the properly sized mounting hole for each fastener.
2. Place fastener in hole on punched side of panel.
3. Be sure the fastener shank or pilot is squarely within the hole before pressure is applied.
4. Apply a steady squeezing force between press and anvil.
5. Use sufficient force to embed the clinching ring around its entire circumference.

## DO NOT:

6. Do not install steel and stainless fasteners in aluminum before the panels have been anodized.
7. Do not deburr mounting holes, as the rough metal is used to help clinch the fastener into the sheet.
8. Do not install the fastener closer to the edge of the sheet than specified in the dimension table for the fastener in use.
9. Do not over squeeze, as this may flatten the fastener head, distort the thread and buckle the panel.
10. Do not install fastener with a hammer blow; doing so does not allow sufficient time for the sheet metal to flow into the clinching profile. A squeezing force is required for optimum performance.
11. Do not install the screw in the head side of the fastener, but from the opposite side, which directs the load toward the sheet.

## NOTES:

1. All installation, pushout and torque-out force references are nominal, based on recommended installation specifications and procedures. Differences in mounting hole dimensions, sheet material and installation methods may alter this data. Testing the performance of this product in application is suggested. Samples are available for this purpose upon request.
2. Dimensional and performance characteristics are subject to change without notice.

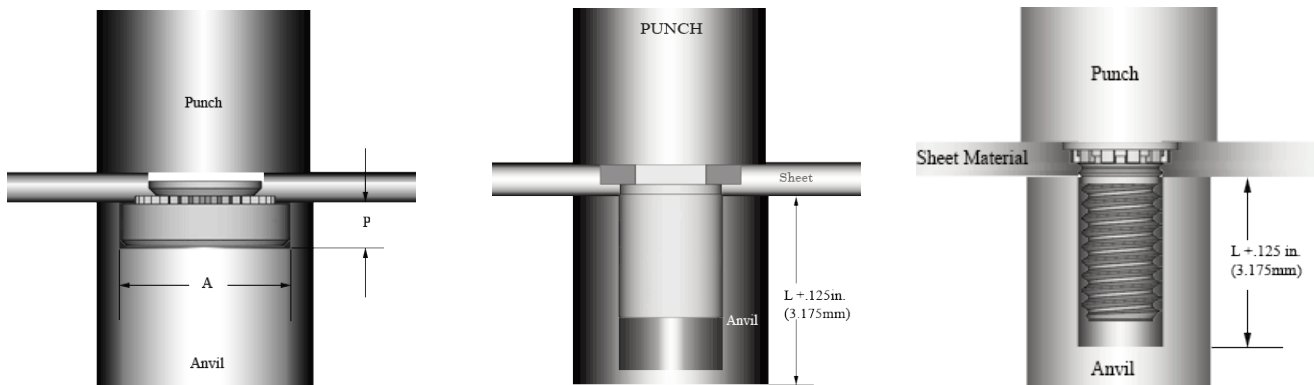





# Sheet Metal Conversion Chart

Inch (in.)

Metric (mm)

Gage No.	Steel	Stainless Steel	Aluminum
7	0.179		
8	0.164	0.172	
9	0.150	0.156	
10	0.135	0.141	
11	0.120	0.125	
12	0.105	0.109	
13	0.090	0.094	0.072
14	0.075	0.078	0.064
15	0.067	0.070	0.057
16	0.060	0.063	0.051
17	0.054	0.056	0.045
18	0.048	0.050	0.040
19	0.042	0.044	0.036
20	0.036	0.038	0.032
21	0.033	0.034	0.028
22	0.030	0.031	0.025
23	0.027	0.028	0.023
24	0.024	0.025	0.020
25	0.021	0.022	0.018
26	0.018	0.019	0.017
27	0.016	0.017	0.014
28	0.015	0.016	
29	0.014	0.017	
30	0.012	0.013	
31		0.011	

Gage No.	Steel	Stainless Steel	Aluminum
7	4.55		
8	4.17	4.37	
9	3.81	6.95	
10	3.43	3.58	
11	3.05	3.18	
12	2.67	2.77	
13	2.29	2.39	1.83
14	1.91	1.98	1.63
15	1.70	1.78	1.45
16	1.52	1.60	1.30
17	1.37	1.42	1.14
18	0.12	1.27	1.02
19	1.07	1.12	0.91
20	0.91	0.97	0.81
21	0.84	0.86	0.71
22	0.76	0.79	0.64
23	0.69	0.71	0.58
24	0.61	0.64	0.51
25	0.53	0.56	0.46
26	0.46	0.59	0.43
27	0.41	0.43	0.36
28	0.38	0.41	
29	0.36	0.36	
30	0.30	0.33	
31		0.28	

## Inch – Metric Conversion Table

Characteristic	When You Know	Multiply By	To Find	When You Know	Multiply By	To Find
Length	Inches	25.4	Millimeters (mm)	Millimeters (mm)	0.03937	Inches
Area	Square Inches	645.16	Square Millimeters	Square Millimeters	0.00155	Square inches
Plating Thickness	Inches	25400	µm	µm	3.937 x 10 <sup>-5</sup>	Inches
Force	Pounds	4.448	Newtons (N)	Newtons (N)	0.2248	Pounds
Torque	Inch-pounds	0.113	Newton-meters (N•m)	Newton-meters (N•m)	8.851	Inch-pounds
Stress	PSI	0.006895	MPa	MPa	145.04	PSI
Stress	KSI	6.895	MPa	MPa	0.14504	KSI

# Galvanic Corrosion Chart

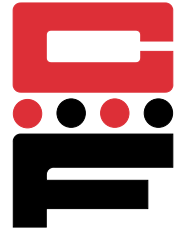

Galvanic Corrosion is a concern when selecting a fastener to be used in a panel of dissimilar metal, especially when it will be subjected to moisture or water. Ideally, the fastener should be the more noble metal and the panel the less noble metal, to reduce the effects of corrosion. Generally, metals close to one another on the chart will not have a strong effect on one another. However, the further apart the materials are on the chart, the stronger the corrosion effect will be on the least noble metal. Therefore, since the fastener is the smaller element, it needs to be made of the more noble metal so it will not be attacked. The larger panel can be of the less noble metal, where corrosion will not affect the larger surface as readily.

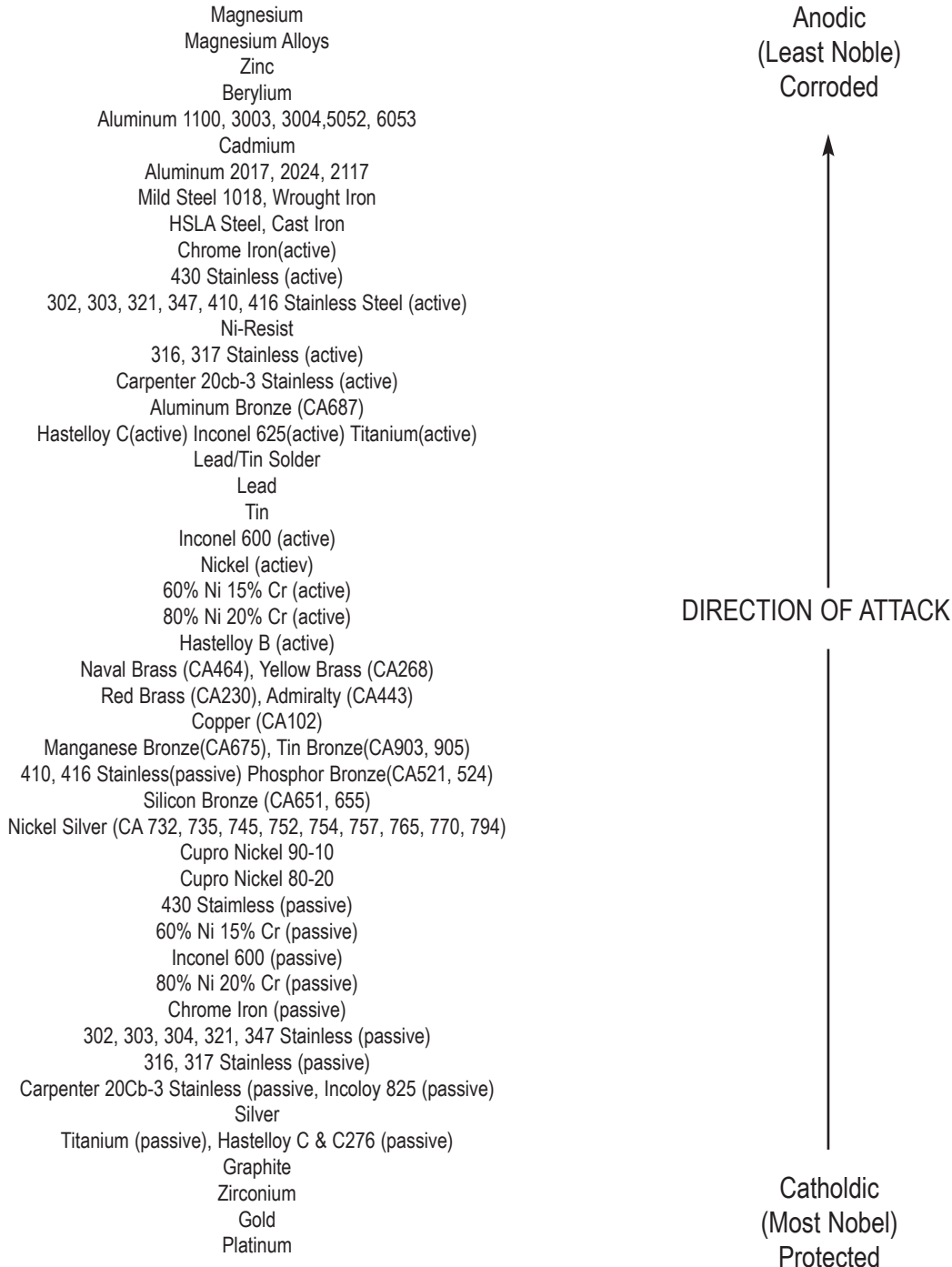





# Part Number Cross Reference Chart

CAPTIVE FASTENER® SERIES	PEM® SERIES	PAGE
CFAS, CFAC	AS, AC	9-10
CFFS, CFFC	LAS, LAC	11-12
CFSP	SP	13-14
CFB, CFBS	B, BS	15-16
C / CS	S,SS / CLS, CLSS	17-21
CFH, CFHN	H, HN	22
CA	CLA	23
CKN	-	24
CFL	F	25-26
CFE, CFEO CFEX, CFEOX	FE, FEO FEX, FEOX	27-28
CRT	LK	29-30
CPL, CPLC	PL, PLC	31-32
CH, CHS, CHA	FH, FHS, FHA	33-35
CHTS	FH4	36-38
CH2S	FHP	39-40
HCH, HCHS, HCHB	HFH, HFHS, HFHB	41-42
HCW	HFE	43-44
TCH, TCHS	TFH, TFHS	45-46
CHE, CHES	FHL, FHLS	47-49
CFA-1, CFA-2 / CFC-1, CFC-2	CHA, CFHA / CHC, CFHC	50-52
CH, CHN, CHS, CHA	FH, FHN, FHS, FHA	53-54
CGS	TPS	55
CKF2, CKFS2	KFS, KFS2	56-57
CKFE, CKFSE	KFE, KFSE	58
CKFH	KFH	59
CKFB3	KFB3	60
CRM	SMTSO	61
CFKSSB	KSSB	62-63
CPFK	PFK	64
LPH-0, 1, 2	PF30, 31, 32	65-66
CPFC2	PFC2	67-68
PSK / PSS	PF11 / PF12	69-70
CFSO, CFSOS, CFSSA CFBSO, CFBSOS, CFBSOA	SO, SOS, SOA BSO, BSOS, BSOA	71-77
CFSSG, CFSSAG	SOSG, SOAG	78
CF40, CF40S	DSO, DSOS	79-80
CF4-S0, CF4-BS0	S04, BS04	81-83
CFSKC	SKC	84-85
CFSO, CFSOS, CFSSA	SO, SOS, SOA	86-87
CFT, CFTS, CFTA	TSO, TSOS, TSOA	88-90
CFSSA, CFSSS, CFSSC	SSA, SSS, SSC	91-92
CFHS-1, CFHS-2	CSS, CSOS	92-95
CFWN, CFWNS	WN, WNS	96-97
CFS2, CFR2, CFN2	PS10, PR10, N10	98-101
CPN, CPR	PSL2, PTL2	102-103

"PEM" is a registered trademark of PennEngineering®

# Product Series Cross Reference

CAPTIVE FASTENER® SERIES	PEM® SERIES	DESCRIPTION	TECHNICAL FEATURE
CFAS, CFAC	AS, AC	Self-Clinching Floating Nuts	Allows for mating hole misalignment. Locking and non-locking versions.
CFFS, CFFC	LAS, LAC	Self-Clinching Floating Locking Nuts	
CFSP	SP	Self-Clinching Nuts for Stainless Steel	
CFB, CFBS	B, BS	Blind Press Nuts	Provides strong internal threads in material too thin to tap. Special versions include blind end, flush, locking and miniature types. Inch and metric sizes in steel, stainless and aluminum.
C / CS	S, SS / CLS, CLSS	Self-Clinching Steel and Stainless Steel Nuts	
CFH, CFHN	H, HN	Self-Clinching Steel Heavy Duty Nuts	
CA	CLA	Self-Clinching Aluminum Nuts	
CKN	-	Self-Clinching KAL-Nuts	
CFL	F	Self-Clinching Flush Nuts	
CFE, CFEO CFEX, CFEOX	FE, FEO FEX, FEOX	Miniature Self-Clinching Self-Locking Fasteners	
CRT	LK	Self-Clinching Self-Locking Nuts	
CPL, CPLC	PL, PLC	Self-Clinching Top Collar Lock Nuts	
CH, CHS, CHA	FH, FHS, FHA	Self-Clinching Studs, Flush Head	
CHTS	FH4	400 Series Studs, for Stainless Steel	
CH2S	FHP	A286 Series Studs, for High Heat / Corrosion environment	
HCH, HCHS, HCHB	HFH, HFHS, HFHB	Self-Clinching Studs, High Torque	
HCW	HFE	Self-Clinching Studs, Wide Head	
TCH, TCHS	TFH, TFHS	Self-Clinching Studs, Thin Sheet	
CHE, CHES	FHL, FHLS	Close-to-Edge Studs	
CFA-1, CFA-2 / CFC-1, CFC-2	CHA, CFHA / CHC,	Self-Clinching Concealed Head Studs	
CH, CHN, CHS, CHA	FH, FHN, FHS, FHA	Self-Clinching Pins	
CGS	TPS	Self-Clinching Tapered Guide Pins	
CKF2, CKFS2 CKFE, CKFSE CKFH CKFB3	KF2, KFS2 KFE, KFSE KFH KFB3	Broaching Type Fasteners for Permanent Mounting in Non-Ductile Materials and Printed Circuit Boards	Provides permanent internal/external threads in PC boards. Variety of standoffs for stacking PC modules. Self-contained panel fasteners broach/clinch into PCB/metal.
CRM	SMTSO	Reel Mounted Spacers and Nuts	
CFKSSB	KSSB	Spring-Top Standoffs for PC Boards	
CPFK LPH-0, 1, 2 CPFC2	PFK PF30, 31, 32 PFC2	PC Board Panel Fasteners Low-Profile Panel Fasteners Self-Clinching Panel Fastener Assemblies	Standoffs that clinch into thin sheet metal allow for stacking of modules and assure good grounding. Inch and metric sizes in steel, stainless and aluminum.
PSK / PSS	PF11 / PF12	Collar Based Self-Clinching Panel Fasteners	
CFSO, CFSOS, CFSSOA CFBSO, CFBSOS, CFBSOA	SO, SOS, SOA BSO, BSOS, BSOA	Self-Clinching Standoffs	
CFSSOG, CFSSOAG	SOSG, SOAG	Self-Clinching Grounding Standoffs	
CF40, CF40S	DSO, DSOS	Miniature Self-Clinching Standoffs	
CF4-S0, CF4-BS0	S04, BS04	400 Series Stainless Steel Standoffs	
CFSKC	SKC	Self-Clinching Slide-Top Standoffs	
CFSO, CFSOS, CFSSOA	SO, SOS, SOA	Unthreaded Thru-Hole Standoffs	
CFT, CFTS, CFTA	TSO, TSOS, TSOA	Thin Head Standoffs	
CFSSA, CFSSS, CFSSC	SSA, SSS, SSC	Spring-Top Standoffs	
CFHS-1, CFHS-2	CSS, CSOS	Self-Clinching Concealed Head Standoffs	
CFWN, CFWNS	WN, WNS	Weld Nuts	Collar prevents weld spatter.
CFS2, CFR2, CFN2	PS10, PR10, N10	Panel Screw Components	Flush mounted, self-retained.
CPN, CPR	PSL2, PTL2	Self-Clinching Spring-Loaded Plungers	Provides position stops on slides.

Special designs available on request.

"PEM" is a registered trademark of PennEngineering®



World Corporate Headquarters

Oakland, NJ



Captive Division

Oakland, NJ



Distributed by

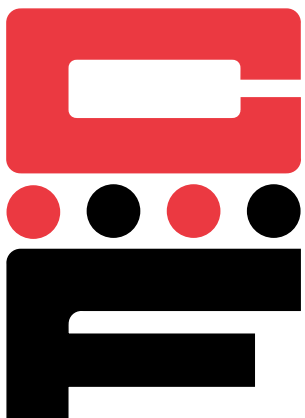

**captive**<sup>®</sup>

fastener corporation

19 Thornton Road, Oakland, New Jersey, 07436 USA

Telephone: (201) 337-6800 FAX: (201) 337-1012

Web Site: [www.captive-fastener.com](http://www.captive-fastener.com)